

International Workshop
**One year after Fukushima:
rethinking the future**

Bologna (Italy)
15-16 March 2012

Edited by G. Grasso and F. Rocchi

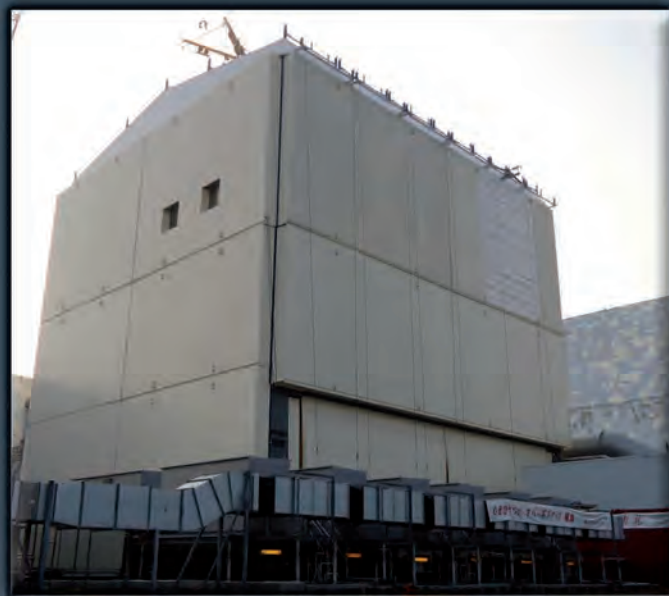

Italian National Agency for New Technologies,
Energy and Sustainable Economic Development





ITALIAN NATIONAL AGENCY FOR NEW TECHNOLOGIES,
ENERGY AND SUSTAINABLE ECONOMIC DEVELOPMENT

International Workshop

One year after Fukushima: rethinking the future

Proceedings

Edited by

G. Grasso and F. Rocchi

Scuola Superiore della Pubblica Amministrazione (SSPA)

Presidenza del Consiglio dei Ministri

Bologna (Italy)

March 15-16, 2012

The Workshop was supported by:

Italian Nuclear Association (AIN)



International Workshop

One year after Fukushima: rethinking the future

Bologna (Italy) – March 15-16, 2012

Proceedings

2012 ENEA

Italian national agency for new technologies, energy and
sustainable economic development

Lungotevere Thaon di Revel, 76
00196 Rome

ISBN 978-88-8286-273-2

TABLE OF CONTENTS

Host's Foreword	5
Editors' Foreword	7
Programme	9
List of Speakers	11
Introductory speech of Giovanni Lelli	13
Introductory Speech of Enzo Gatta	15
Technical Session 1 – The accident: sequence and consequences	17
RECONSTRUCTION OF THE ACCIDENT SEQUENCE	19
AND ACCIDENT MANAGEMENT	19
THE JAPANESE EMERGENCY RESPONSE TO THE ACCIDENT	31
FUKUSHIMA DAI-ICHI'S RADIOACTIVE SOURCE TERM AND RELEASE IN THE ENVIRONMENT	37
Technical Session 2 – The roadmap: status and perspectives towards the restoration.....	47
INTRODUCTION TO THE RESTORATION ROADMAPS	49
RADIATION MONITORING AND ENVIRONMENTAL DECONTAMINATION PERSPECTIVES	55
Technical Session 3 – The future: lessons learned and evolution perspectives	61
EMERGENCY PREPAREDNESS AND ON-SITE AND OFF-SITE RESPONSE SYSTEMS	63
Presentations	71
RECONSTRUCTION OF THE ACCIDENT SEQUENCE AND ACCIDENT MANAGEMENT.....	73
THE JAPANESE EMERGENCY RESPONSE TO THE ACCIDENT.....	99
FUKUSHIMA DAI-ICHI'S RADIOACTIVE SOURCE TERM AND RELEASE.....	121
INTRODUCTION TO THE RESTORATION ROADMAPS.....	135

STATUS AND PERSPECTIVES OF PLANT RESTORATION PROCESS.....	149
RADIATION MONITORING ACTIVITIES AND ENVIRONMENTAL DECONTAMINATION PERSPECTIVES.....	191
REVIEW OF THE LESSONS LEARNED FROM THE ACCIDENT.....	217
NUCLEAR SAFETY ACTION PLAN – KEY ACHIEVEMENTS.....	239
THE STRESS TESTS ON THE EUROPEAN LWR FLEET.....	251
EMERGENCY PREPAREDNESS AND ON-SITE AND OFF-SITE RESPONSE SYSTEMS.....	269
CONSEQUENCES AND FOLLOW-UP OF THE FUKUSHIMA ACCIDENT ON EU AND NON- EU COUNTRIES.....	283

Host's Foreword

The first and most important aim of the Workshop that has been organized in Bologna, one year after the Fukushima events, was learning. Learning what actually happened to the Nuclear Power Plant, and how it developed. Learning what real impact these events had on people and on the environment, after a considerable amount of data has been collected through intensive and extensive measurements. And last, learning how the causes can be analyzed for improving the robustness and our response to potential accident initiators in the most safe way as possible.

Learning more about the events that had a relevant role in determining a change in the energy policy planned by the government. As known, in 2008 some preparatory laws were promulgated, together with regulations and international agreements, set for paving the way to a nuclear “renaissance”, aimed at tuning the Italian electricity source mix and in accordance with the European requirements following the Kyoto Protocol. But, as in 1987 after the Chernobyl accident, the decision whether to go nuclear or not was left to the people, with a popular referendum happened just three months after the earthquake and tsunami that hit Japan on March, 11th.

The expected result is a clear evidence that, allowing the public opinion to influence – or even determine – national energy policies is a risk to the rationality of the decisions to be taken, subjugating the ability to plan a balanced energy mix to the lack of information, and scientific culture in general. The first lesson that the Italian nuclear community learned from the Fukushima accident is the urgent need for a wide dissemination of a sound scientific (and energy, and nuclear, in particular) culture amongst the population, which is the only key to have the public opinion set on a rational rather than emotional basis. And teaching the teachers, and informing the informers, is the first step to revert this irrational status quo.

That is why the Workshop had to be addressed to nuclear scientists and technicians. Why the organization spent the most part of its time in trying to gather the most eminent experts in the fields of interest, for an exhaustive technical analysis of the accident: much more could be done by an informed and coherent class of technicians, rather than through a single public event. The sharing of precise and up-to-date information within the nuclear scientific community, and the possibility to discuss among each others to reach a common position on the problem, from many different but complementary points of view, would have allowed indeed a much more widespread information to the public.

The organization of such a Workshop was not an easy task at all, so that – in putting together these proceedings – no better conclusion can be drawn to a foreword than acknowledging who made possible this to happen; many people were actively involved in this job, both inside and outside ENEA, naming all of them would be impossible. Mr. Giovanni Lelli, as General Commissioner of ENEA, encouraged and supported the decision to organize this Workshop. The Italian Nuclear Association, AIN, generously decided to co-sponsor the event; the Scuola Superiore della Pubblica Amministrazione, SSPA, of the Presidenza del Consiglio dei Ministri hosted the Workshop in the Aula Magna of its beautiful venue in Bologna. Both organizations are gratefully acknowledged. The Service for Information and Promotion of ENEA Projects of the ENEA Relations Central Unit actively contributed at supporting the organization of the Workshop, including the mobilization of the ENEA Web TV and its staff for documenting the works during the two days. The Italian Permanent Mission to the UN in Vienna contributed at making possible the participation of the Special Coordinator for the IAEA Action Plan on Nuclear Safety at the Workshop, as well as the inclusion of the Workshop among the initiatives undertaken by Italy for promoting nuclear safety, in accordance with the directives of the

IAEA's Action Plan. The active contribution of Mr. Kuniyisa Soda, who helped the Organizers to contact some distinguished Japanese expert for the scientific schedule of the Workshop. All the colleagues that – through their lectures – contributed at keeping the scientific level of the Workshop high, as desired. And last – but not least, as use – Mr. Federico Rocchi and Mr. Giacomo Grasso for the scientific coordination, together with all the friends and colleagues of the Technical Unit for Reactor Safety and Fuel Cycle Methods (UTFISSM) of ENEA, who actively worked for the practical organization and management of this successful Workshop: Ms. Franca Padoani, Mr. Felice De Rosa and Ms. Patrizia Gazzi.

Paride Meloni

Head of Technical Unit for Reactor Safety and Fuel Cycle Methods (UTFISSM) – ENEA
October 2012

Editors' Foreword

One year after the accidents occurred at the Fukushima Dai-ichi nuclear power station as a consequence of the disastrous Tōhoku earthquake and subsequent tsunami, it was decided to organize a two-days International Workshop in Italy with the aim of taking stock of the current situation. Many similar occasions are being organized at all levels throughout the world, the foremost ones being those of the IAEA Action Plan on Nuclear Safety. It was felt however that a special event in Italy was absolutely necessary. With the precious help and participation of specialists in the areas of safety analysis, accident management and radiation protection from all over the world, we tried to cover all the aspects related to the accidents, namely:

- the analysis of the initiating events, the sequence and the consequences;
- the roadmap planned for the plant and environment restoration, as well as the status of the situation in Japan one year after the event;
- the lessons learned and the impact that the accidents have had on the nuclear sector in general.

The three Technical Sessions in which the Workshop was divided reflect indeed the selected aspects. The Workshop resulted in a fruitful and precious occasion for studying, learning, sharing experience, and disseminating knowledge in various fields. Many perspectives and points of view were offered, from utilities to regulatory agencies, from Technical Safety Organizations to research laboratories. Several technical and technological issues have been presented. All this, together with the participation of about 100 attendees, made the event successful.

Besides the grateful thanks to the many people involved in all the organizational aspects of the Workshop and mentioned by Paride Meloni in his foreword, ENEA also acknowledges the people who kindly agreed to act as Chairmen of the Sessions, namely Jean-Claude Bouchter, Appointed Advisor to the French Embassy in Rome, Lamberto Matteocci, of Istituto Superiore per la Protezione e la Ricerca Ambientale ISPRA, and Francesco Troiani, ENEA. A special thank goes to all the eminent specialists, friends and colleagues, as well as to the Organizations they represent, who agreed to deliver speeches at the Workshop and dedicated part of their time to prepare their presentations and papers. The Japanese delegation, coordinated by Kuniyoshi Soda (JAEA), is to be praised for its successful efforts in presenting the latest data and analysis. The IAEA was represented by Gustavo Caruso, the Special Coordinator for the IAEA Action Plan on Nuclear Safety; ENSREG was represented by its Chair Andrej Stritar.

This volume, which appears in the ENEA Proceeding Series, contains six papers, collected together in the first part, and the presentations given at the Workshop. Both papers and presentations are given here because they are complementary in nature and content to each other and cross-references between them is sometimes made. Some authors provided both the presentation and a paper, others only the presentation. Donald Kalinich (SNL) was unfortunately unable to present his results at the Workshop, due to non-disclosure internal policies at the time; he provided nonetheless a bird's eye view of the overall setup of the work.

The Japanese Roadmap towards the restoration is well ahead, notwithstanding the many difficulties presented by case. Decontamination is ongoing and will last at least for some years, with the introduction of novel and recent techniques. The road to recovery is taken.

As we go to the press, Ohi 3 and Ohi 4 nuclear power plants have restarted commercial operation, all the necessary safety assessments having been completed; Ikata 2 is waiting for the confirmation by NSC and governmental approval for restart, and other 27 NPPs of the Japanese fleet have completed and submitted their Stress Tests to NISA and wait for the next

steps in the chain for restarting approval. All over the world 435 nuclear reactors still produce about 370 GW of electric power, and other 64 new units are under construction.

Despite the severe impact the Fukushima events have had on the public opinion worldwide, the nuclear option still remains one of the main pillars of the sustainable, economic and reliable production of electricity, with the global nuclear share destined to increase steadily in the forthcoming years. According to this, we hope these proceedings might help scientists and technicians in forming a rational view of the facts, and to approach science and engineering with a renewed hope in the possibility of conceiving ever safer nuclear energy systems.

Giacomo Grasso, Federico Rocchi

ENEA – UTFISSM
October 2012

Programme

Thursday, March 15

08:30 – 09:00 Registration

09:00 – 09:05 Opening

09:05 – 09:15 Welcome address of Authorities

09:15 – 09:25 Introductory Remarks

ENEA

Giovanni Lelli

JAEA

Kunihisa Soda

AIN

Enzo Gatta

Technical Session 1 – The accident: sequence and consequences

Chairperson: *Jean-Claude Boucher*

09:25 – 10:10 Reconstruction of the accident sequence and accident management

Takashi Sato

10:10 – 10:55 Evaluation of core damaging at Units 1 to 3

Donald A. Kalinich

10:55 – 11:05 *Coffee break*

11:05 – 11:50 The Japanese emergency response to the accident

Toshio Fujishiro

11:50 – 12:35 Evaluation of the Source Term

Giovanni Bruna

12:35 – 13:00 Discussion Panel

13:00 – 14:30 *Lunch*

Technical Session 2 – The roadmap: status and perspectives towards the restoration

Chairperson: *Lamberto Matteocci*

14:30 – 15:15 Introduction to the Restoration Roadmap

Kunihisa Soda

15:15 – 16:00 Status and perspectives of plant restoration process

Takashi Sato

16:00 – 16:15 *Coffee break*

16:15 – 17:00 Radiation monitoring activities and environmental decontamination perspectives

Kimiaki Saito

17:00 – 17:30 Discussion Panel

Friday, March 16

Technical Session 3 – The future: lessons learned and evolution perspectives

Chairperson: *Francesco Troiani*

09:00 – 09:45	Review of the lessons learned from the accident	<i>Toshihiro Bannai</i>
09:45 – 10:30	The IAEA Action Plan: making nuclear power safer	<i>Gustavo Caruso</i>
10:30 – 10:45	<i>Coffee break</i>	
10:45 – 11:30	The Stress Tests on the European LWR fleet	<i>Andrej Stritar</i>
11:30 – 12:15	Emergency preparedness and on-site and off-site response systems	<i>Giovanni Bruna</i>
12:15 – 13:00	Consequences and follow-up of the Fukushima accident on EU and Non-EU countries	<i>Giuseppe Zollino</i>
13:00 – 13:30	Discussion Panel	
13:30 – 13:45	Conclusions	
	ENEA	<i>Piergiuseppe Maranesi</i>
	AIN	<i>Umberto Minopoli</i>

List of Speakers

Toshihiro BANNAI

Director, International Affairs Office
NISA – Japan

Giovanni B. BRUNA

Scientific Director
IRSN – France

Gustavo CARUSO

Special Coordinator for the
IAEA Action Plan on Nuclear Safety
IAEA

Toshio FUJISHIRO

Special Advisor
RIST – Japan
Former NSC Special Committee

Donald A. KALINICH

Principal Member of Technical Staff
Sandia NL – USA

Kimiaki SAITO

Headquarters of Fukushima
Partnership Operations
JAEA – Japan

Takashi SATO

Nuclear Power & Plant Siting
Administrative Dept.
TEPCO – Japan

Kunihisa SODA

Fellow
JAEA – Japan
Deputy Chairman of JNSC

Andrej STRITAR

Head
SNSA – Slovenia
Former Chair of ENSREG¹

Giuseppe ZOLLINO

Professor at University of Padova,
AIN – Italy

¹ Mr. Stritar was in charge of the ENSREG Chairmanship at the time of the Workshop.

Introductory speech of Giovanni Lelli

ENEA Commissioner

First of all I want to greet and thank all those who participate in this seminar today, and in particular I wish to give a warm welcome to our Japanese guests. Thanks for being here with us to debate on a so important subject.

On behalf of the Agency as a whole, let me take the occasion to express our deepest sorrow for the Japanese people, in memory of the 19000 victims lost or missing. At the same time there is a reason to hope in a rapid reconstruction, inspired by the extraordinary fortitude shown by the Japanese people in facing such unimaginable losses. The friendship and closeness of Italian and Japanese people are strengthened by the ongoing collaborations and links between us, like this Workshop, as we seek to identify common fields of research and cooperation between our scientific communities.

Looking at the program of the works, I am sure you will face all the most important issues concerning the accident. I know that this stimulating discussion will provide us additional elements useful for the evolution of the design of the new generation reactors.

By my side let me focus the attention to other aspects that I consider relevant to offer a wider framework when we talk about rethinking of the Fukushima accident

It is not the first time that we rethink of the nuclear option in Italy. We already did after Chernobyl and the solution we adopted was just... delete the nuclear program and now, again, we solved the problem: just deleting the nuclear option.

I'm not the one who wants to take over the popular sovereignty taking on the role of the technocrat that solves all the problems with technology; but I'd like to take the opportunity of a rethinking phase, focusing the attention on how our country can tackle complex problems. I am thinking specifically of the social acceptance of relevant infrastructural projects. I am referring for example to what is happening about the High Speed Rail in Val di Susa and what happened about Scanzano Jonico: how will we face the selection of a site for nuclear waste repository without a public acceptance approach? This is a problem that cannot be avoided since our obligations will be soon on the table.

About additional aspects of the post-Fukushima accident not strictly related to the accident itself, we must consider some basic directions of the discussion of our future energy system without the nuclear option.

Our Ministry of Economic Development, just a few days ago, gave the outlines of the strategy.

1) fundamental reinforcement of energy and electricity conservation measures by considering reform of user behavior in view of a greater energy efficiency, 2) effective utilization of fossil fuel and hence the increase of gas use, 3) accelerated development and use of renewable energies to the maximum degree to reach the EU goals in terms of Green House Gas reduction at 2020 and later on, 4) ensure the widest possible alternative sources of supply.

As the basis for developing a new strategy, power generation cost data must be reviewed to examine the most optimized energy mix. ENEA is strongly committed, as mandated by the Ministry of the Economic Development, to elaborate scenarios disclosing all assumptions and calculation methods by making use of currently available knowledge and information. The analyses are showing that in the actual framework of social development, 1) coal and natural gas are cost-competitive, as base power sources, 2) renewable energies are expected to play certain roles suitable to their power source characteristics, 3) distributed power sources, including customer side cogeneration, 4) each power source has its own advantages and disadvantages.

Of course we cannot avoid to consider Italy into the international framework and the review policies of some countries in which nuclear is still an option and from which energy is imported to Italy, can affect our energy mix and we need to monitor the economic consequences on our energy system.

Italy is at the forefront in understanding how these policies are evolving, and also what are the results of the stress tests that the nuclear neighboring countries are doing for safety reasons.

ENEA is not going to rethink its research policy in the nuclear field. Not any step back in our participation in international projects related to fission (Generation IV) and fusion (ITER). Maybe reinforcing our presence is the right word to be used.

As far as fission is concerned, the issue of safe and secure management of nuclear activities has to be addressed as well as the surveillance of international nuclear activities, paying particular attention to the plants operating near our borders and the commitment to establish and manage a national repository of nuclear wastes.

In conclusion I would like to share with you the words of the Japanese writer Banana Yoshimoto that I read in a recent article, entitled "happiness a year after the tsunami". Yoshimoto – after the tragic events of the tsunami and the suffering consequences of the Fukushima nuclear accident – writes: "I feel lucky in one thing, namely, to be returned to a fundamental principle: thinking about the things is based on a reference value. The reference value is taking care of the people." I do believe that our role of researchers in support of the energy policy is taking care of the people: to work in the energy field is to work for the future generation and we will go on to investigate and to develop the best technology options for the happiness of our sons in a safer and more secure world.

But before the Workshop begins, please allow me to acknowledge the great work of the Technical Unit for the Reactor Safety and Fuel Cycle Methods², and particularly its head Paride Meloni, to make this meeting happen.

Let me also thank Giovanna Rizzo, Director of the School of Public Administration, for kindly offering to host this event.

Let me also wish all of you a profitable time and a fruitful workshop.

² UTFISSM (ed.)

Introductory Speech of Enzo Gatta

President, AIN

We have to think anew

As President of the Italian Nuclear Association, I am very pleased to welcome all the distinguished participants to this International Workshop, much properly titled after “rethinking the future” and, most of all, I enjoy in thanking ENEA for organizing it, and very especially the young colleagues that so carefully have been looking after all of this. The international nuclear community was born and has risen since the very beginning after considerable scientific efforts, within a wide collaboration and after a very challenging intellectual endeavor. The good faith in a future made up by what intelligent men can invent for obtaining clean energy has been the distinctive character of the nuclear adventure: the only source that takes care of all the life cycle of the fuel and the plant components ‘from the cradle’ to the very end of it. In recent years many new ideas have been put forward. New concepts of reactor, more safe and secure and markedly sustainable have been proposed, and some of them can now be built by industry. Advances have actually come forth both from industrial side and from research & development reactors. We face in fact now new industrial trends, driven not only by eastern countries development such as China or India, but also new installations from the northern Europe, Turkey and United States of America. All this was named years ago by someone as a nuclear renaissance, which is still ongoing. Last year a terrible natural catastrophe has hit Japan and shocked the whole world. The Tohoku earthquake of 2011 is believed to be one of the largest earthquakes in recorded history. We have to keep in mind that it, along with the tsunami it triggered, is estimated to have caused nearly 20,000 deaths and economic losses approaching \$500 billion (USD). Our warm welcome and thank has now to be addressed and devoted to our Japanese colleagues, both for their important work which they will share with us later, and for having come here, in Italy, as a sign of our mutual friendship and willingness of further fruitful collaborations.

One year after the tsunami we think we can face up, somehow clearly, what the real aftermath of it has been, of course mainly from the scientific point of view of the nuclear science community and from the point of view of the safety of the nuclear power plants. First of all we have to notice and to be aware of the fact that no other human manufactured structure would experimentally show to be tough as nuclear power plants have shown. It is hard to figure out what such a tsunami would mean in case it would strike the most robust structures we are familiar with in our everyday’s life. This, by itself, confirms the principles of in-depth defense under which the nuclear power plants are designed. But, after all of it, what a responsible technical community facing the future is expected to do is an in-depth analysis and review of both the existing power plants and of the new designs which are built now, while we are speaking, and that will be built in the near next years. Moreover and once more much attention has been put on the “beyond basis accident design”, and the nuclear community and only the nuclear community has been considering since long time very, very unlikely accident features. This has turned out in providing industrial nowadays mature plants equipped mostly with passive safety systems, and even core catchers in the very unlikely case of a massive core fusion. These efforts, after the consequences of Tohoku tsunami and Fukushima Dai-ichi accident has been much strengthened. This shows that the nuclear systems, which have caused no injuries in Japan following all the credited national and international reports on this subject, are still looked after the most carefully by the one and the only technical community

of scientists that enjoys doing what they are expected to do, which is do learning and keeping learning from any and every lesson they can catch, taking into account every technical detail.

So, as everybody of you perfectly knows, the European Union has asked to every European Country, under the responsibility of the national safety authorities, to carry out the so-called Stress Tests, each on his own existing plants: duty that every Country accepted and on which the first preliminary encouraging results are coming out. The United States Nuclear Regulatory Commission already evaluated as appropriate the safety of U.S. NPP in the light of the lessons to be learned by Tohoku-Fukushima accidental sequence, and just few days ago the American Nuclear Society released its comprehensive report on this subject. The Italian Nuclear Association has made up a task-force which have promptly released reports on the subject and ENEA, the Italian National Agency for New Technologies, Energy and Sustainable Economic Development, prepared and released a very valuable reference report, carrying out the crucial role of an independent technical support organization for nuclear systems assessment. All these are the clear signs of a technical community which is aware of its scientific responsibilities and that faces the future with the capability of "rethinking the future". We all are aware of our permanent duties and intellectual responsibilities, which require to keep thinking anew and acting anew. Of course this will be required, in the frame of the European and international treaties that identify Italy as a full nuclear Country and it will be necessary first of all that ENEA and the Italian Universities will be encouraged in their mission of higher scientific education for building a strongly connected research and education system for the young scientists of the future. Moreover, since we span from very fundamental science up to industrial research, it is necessary to increase the connections between Universities, ENEA as necessary R&D focal point, and industries. We are aware of the fact that our international colleagues would expect contributions from Italian science at the level of the tradition of the Italian nuclear science school. A good public information on this subject will have to follow and will be one piece of an integrated multi-disciplinary work which is typical of nuclear. The work which we are starting today here is for all of us and for the progress of our communities of an outstanding importance. That's why the Italian Nuclear Association wishes all of you the most fruitful time here in Bologna, time devoted to 'rethinking the future'.

Thank you very much.

Technical Session 1 – The accident: sequence and consequences

RECONSTRUCTION OF THE ACCIDENT SEQUENCE AND ACCIDENT MANAGEMENT

Takashi SATO

Nuclear Power & Plant Siting Administrative Dept., Tokyo Electric Power Company, Co.,

Abstract

This paper is given in order to share the detailed information on the Fukushima Accident which occurred on March 11, 2011, and the lessons learned from it which worldwide nuclear experts might currently have more interest in. The paper first reflects how the facilities were damaged by a very strong earthquake and a series of beyond design-basis tsunamis. The earthquake caused loss of all off-site electric power at Fukushima Daiichi Nuclear Power Station (1F), and the following series of tsunami made all emergency diesel generators except one for Unit 6 and most of DC batteries inoperable and severely damaged most of the facilities located on the ocean side. Thus all the units at 1F resulted in the loss of cooling function and ultimate heat sink for a long time period. TEPCO focused on restoration of the instruments and lights in the Main Control Room (MCR), preparation of alternative water injection and venting of Primary Containment Vessel (PCV) in the recovery process. However, the workers faced a lot of difficulties such as total darkness, repeated aftershocks, high radiation dose, a lot of debris on the ground, loss of communication means, etc. Massive damages by the tsunami and lack of necessary equipment and resources hampered a quick recovery. It eventually resulted in the severe core damage of Unit 1, 2, and 3 and also the hydrogen explosions in the reactor buildings of Unit 1, 3, and 4. This paper finally extracts the lessons learned from the accident and proposes the countermeasures, such as flood protection for essential facilities, preparation of practical and effective tools, securing communication means and so on. These would help the people involved in the nuclear industries all over the world properly understand the accident and develop their own countermeasures appropriately.

Keywords

Fukushima, Earthquake, Tsunami, Accident

Introduction

Approximately nine months after the Fukushima Accident occurred, the Tokyo Electric Power Company (TEPCO) released on December 2, 2011, the Interim Report on Fukushima Nuclear Accident compiled by the TEPCO-internal Accident Investigation and Verification Committee under the Nuclear Safety and Quality Assurance Council. Based on the Interim Report, this paper reflects what actually happened mainly at Fukushima Daiichi Nuclear Power Station, how the facilities were damaged and how TEPCO responded in the recovery process, analyses the lessons learned specifically and finally proposes the basic direction of countermeasures.

1. Overview of Event Sequence

On March 11, 2011, at 14:46, a M9.0 earthquake, 4th largest record in the world, occurred off the coast of the northern part of the Mainland of Japan. The earthquake caused huge scale of tsunamis which destroyed the coastal area of the Tohoku district. At the time of the earthquake, TEPCO was operating 3 of the 6 BWR plants at Fukushima Daiichi Nuclear Power Station (1F) and all 4 units at Fukushima Daini Nuclear Power Station

(2F), which are located about 180 km away from the epicenter. At 1446, all of these 7 units automatically shut down by detecting large earthquake acceleration. The maximum acceleration detected at 1F was 550gal at the basement of the Unit 2 reactor building. This earthquake caused loss of all off-site electric power at 1F site and 12 on-site Emergency Diesel Generators (EDGs) were automatically started.

About 40 minutes after the earthquake, series of tsunamis started to hit the sites. The tsunami height was about 13 meters at 1F site based on analysis, which was far beyond the design basis of the site, and all the units in the site were inundated. The hydrodynamic forces of tsunami damaged most of facilities in the field and significant amount of sea water flew into the buildings from their openings. As a result, all EDGs except one for Unit 6 and most DC batteries lost their functions, and ultimate heat sink cooling water pumps also lost functions.

Under the Station Black Out (SBO) condition together with severe damage to ultimate heat sink, Unit 1 first lost its core cooling function and core damage started about 3 hours after the earthquake on an analysis basis. On Unit 2 and 3, steam-driven water injection systems, Reactor Core Isolation Cooling system (RCIC) and High Pressure Coolant Injection system (HPCI), could maintain its function for the following few days, but these pumps eventually failed and all cooling functions were lost finally. Although site workers made tremendous efforts in order to restore core cooling function using fire engines, continuous aftershocks, tsunami alerts, and extensive damage of the facilities hampered their recovery efforts, and the work could not be successful before the beginning of the core damage due to inadequate core cooling in both Unit 2 and 3.

The core damage in Unit 1, 2 and 3 resulted in generation of substantial amount of hydrogen and it leaked out to the reactor buildings. The hydrogen was then accumulated in the buildings and it led to the explosion in Unit 1 one day after the tsunami, and also in Unit 3 on the third day from the tsunami. On the following day, another explosion occurred in Unit 4, which is considered as a result of hydrogen backflow from the Unit 3 vent line through the SGTS piping. This accident was later rated as level 7 on the International Nuclear and Radiological Event scale (INES), as a result of major release of radioactive material with widespread health and environmental effects requiring implementation of planned and extended countermeasures.

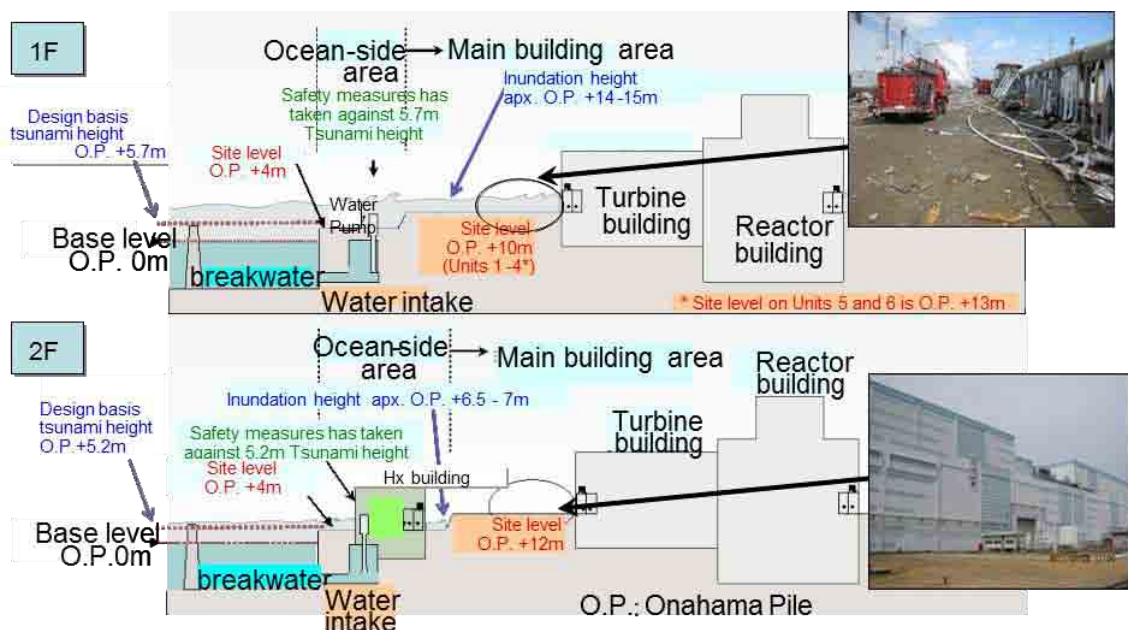

Figure 1 - Inundation status at 1F and 2F site

2. Attack of the Earthquake and Tsunami

The M9.0 Tohoku-Chihou-Taiheiyo-Oki Earthquake on March 11 was caused by combination of several focal areas which ranged approximately 500 km in length and 200 km in width extending from offshore of Iwate Prefecture to the offshore of Ibaraki Prefecture. The ground motion that 1F experienced was nearly equivalent to the design basis seismic ground motion per the plant design.

About 40 minutes after the earthquake, the series of tsunami reached both 1F and 2F sites. The 1F site was attacked by approx. 13 m height of tsunami on an analysis basis and the whole area surrounding the major buildings of Unit 1 to 4 was flooded to a depth of approx. 1.5 m to 5.5 m. The depth of water surrounding the major buildings of Unit 5 and 6 was less than 1.5 m. The 2F site was also attacked by the tsunami. Although the average tsunami height was smaller than the 1F site, approx. 9 m based on analysis, the height of the tsunami which ran up along the road on the southern side of Unit 1 was about 15-16 m.

Figure 1 shows relationship between the design basis tsunami height, site elevation and the inundation height recorded on March 11. Both 1F and 2F sites were originally designed to withstand the design basis tsunami height of 3.122 m, which was determined as the highest historical value of that area recorded after the Chile earthquake in 1961.

In 2002, a new design guideline "Tsunami Assessment Method for Nuclear Power Plants in Japan" was issued by the Japan Society of Civil Engineers. This document has since then been used as the standard method of tsunami assessment at nuclear power stations in Japan. The design basis tsunami height was reevaluated based on this guideline and the new design criteria was set to O.P. +5.4 to 5.7 m for 1F site and O.P. +5.1 m to 5.2 m for 2F site. Since the major building area was constructed at the elevation of O.P. 10-13 m, it was considered that even if the site were attacked by a tsunami with reevaluated height, tsunami wave would not reach the major buildings. On the other hand, regarding the facilities located in the lower elevation, some modifications such as sealing of openings and relocation of pump motors to higher elevation was conducted in order to enhance the resistance against tsunami hazard.

However, the tsunami on March 11 was far beyond the reevaluated design basis and it severely damaged the facilities on the site.

3. Impact on the Facilities

After the earthquake, all the offsite power was lost due to the damage to circuit breakers and disconnectors or collapse of a transmission line tower. Soon after the loss of offsite power, all of 12 EDGs which were ready for operation at that time started up as expected and continued supplying electricity to all the 6 units, and the reactor shutdown operation was successfully implemented.

However, the arrival of the tsunami waves changed the situation drastically. Figure 2 shows the status of loss of in-house power supply for Unit 1 to 4 at the 1F site after the tsunami attack. All the 7 operating EDGs for Unit 1 to 4 lost their function due to flooding and failure of the associated Metal Clad (M/C) switchgears, the sea water pump motors or the EDG's main unit (Table 1). In addition, most of batteries installed in these units were also flooded and damaged. As a result, Unit 1-4 had lost mostly the entire power source and had to face the SBO condition. This means loss of all the functions which utilizes electricity, that is, motor-driven pumps and valves were no longer usable for continuing reactor cooling and instruments in the main control rooms (MCRs) could not show the indication for vital plant parameters.

At the 1F site, 10 out of 13 EDGs are water-cooled and 3 EDGs are air-cooled. Because of this diversity and the location of the system, one of the air-cooled EDG for Unit 6 could survive even after the tsunami. (Remaining two air-cooled EDGs for Unit 2 and 4 lost their function

due to M/C submergence.) This EDG continued to supply electricity to Unit 6, followed by Unit 5 whose important loads were connected using temporary cables from Unit 6 switchgears, and it contributed significantly to leading these units into cold shutdown. This meant the flood protection was important not only for the EDG itself, but also for the associated electric facilities such as M/Cs and batteries.

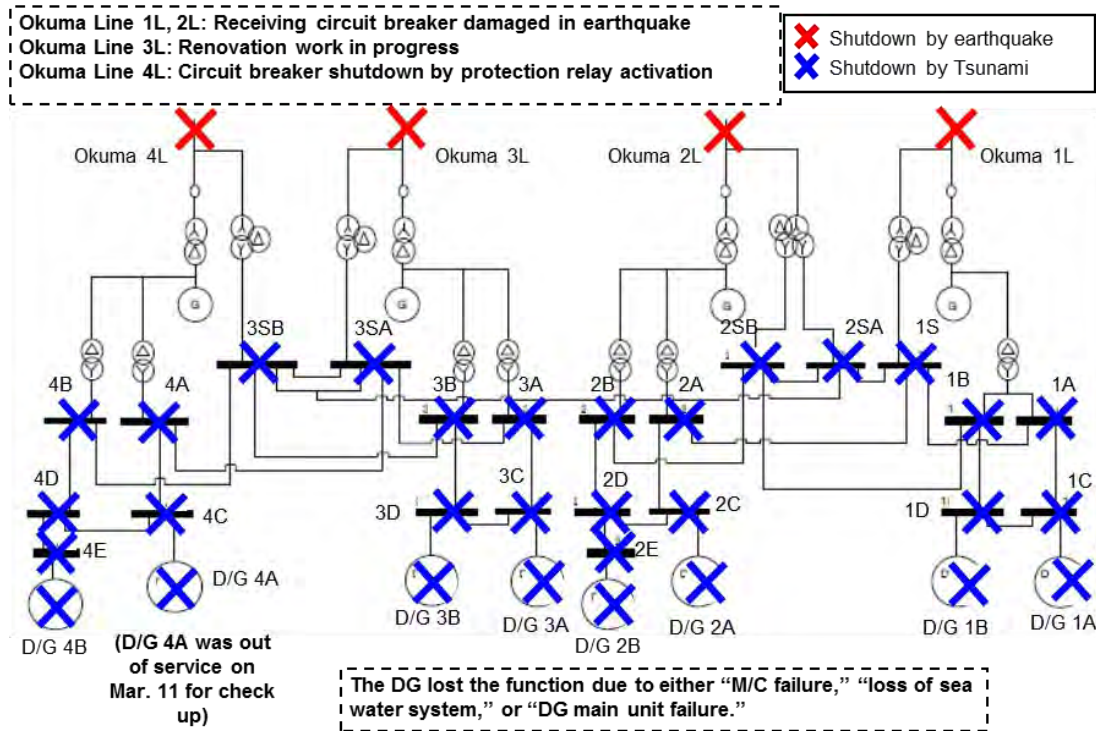

Figure 2 - Damage to power supply systems for Unit 1-4 at 1F site

Table 1 - Location of EDG, M/C switchgear & battery and cause of failure

Unit	EDG		M/C Location	Battery Location
	Location	Cause of failure		
1	1A:T/B B1F O.P.1900	Damaged by flooding	T/B 1F	C/B B1F
	1B:T/B B1F O.P.1900	Damaged by flooding		
2	2A:T/B B1F O.P.1900	Damaged by flooding	T/B 1F	C/B B1F
	2B:SP/B 1F* O.P.10200	M/C submerged		
3	3A:T/B B1F O.P.1900	Damaged by flooding	T/B B1F	T/B MB1F
	3B:T/B B1F O.P.1900	Damaged by flooding		
4	4A:T/B B1F O.P.1900	Damaged by flooding	T/B B1F	C/B B1F
	4B:SP/B 1F* O.P.10200	M/C submerged		
5	5A:T/B B1F O.P.1900	Cooling function lost	T/B B1F	T/B MB1F
	5B:T/B B1F O.P.1900	Cooling function lost		
6	6A:C/S B1F O.P.1000	Cooling function lost	C/S B2F	T/B MB1F
	6B:DG/B 1F* O.P.13200	Survived	C/S B1F	
	6H:C/S B1F O.P.1000	Cooling function lost	C/S 1F	

* Air cooled Diesel Generator

SP/B: Shared Pool building,
DG/B: Independent DG building,
C/B: Control Building,
C/S: Combination Structure, surrounding R/B

The Section 2 and 3 could be summarized as follows:

The Fukushima Accident was caused by the tsunami far beyond the design basis. No significant damages by the earthquake have been confirmed.

The current design of safety-related electric and instrumentation & control equipment might consequently not be robust enough to prevent common cause failure by severe external flooding and their layout, diversity and internal barriers for separation need to be reviewed.

4. Recovery Works

4.1 Initial Challenge of Core Cooling

On Unit 1, Isolation Condenser (IC) and High Pressure Coolant Injection system (HPCI) are designed for cooling and for water injection in high pressure condition. Following the reactor scram after the earthquake, the IC was automatically started up due to reactor pressure high signal. Operators repeatedly started and stopped the IC to control the cooldown rate of the Reactor Pressure Vessel (RPV) temperature within 55 °C/h. After the tsunami attack, AC power supply to Unit 1 was lost. Although both of IC and HPCI are designed to be operable by DC power, operators could not start up these systems due to the damage to the batteries and subsequent loss of DC power. That means, Unit 1 lost its cooling function under the SBO condition and core damage is considered to have started soon after the tsunami. In addition to the loss of cooling function, DC power supply to the instruments in the MCRs was soon stopped and operators lost all the data necessary to understand the plant conditions.

On Unit 2 and 3, the RCIC and HPCI are designed for water injection in high pressure condition. Following the reactor scram after the earthquake, operators used the RCIC in order to maintain the cooling function in both units. After the arrival of the tsunami, AC power supply to both units was lost, but the steam-driven RCIC could still keep its water injection capability although the SBO condition made operators difficult to verify that the RCICs were still in operation. Consequently, RCIC of Unit 2 worked for about three days after the tsunami attack. The RCIC of Unit 3 worked for about 21 hours after the tsunami attack and the HPCI worked for about 14 hours after the RCIC was tripped.

4.2 Difficulties in Recovery Works

Operators and emergency response teams mainly concentrated on the following three tasks; (1) Restoration of the instruments and lights in the MCR, (2) Preparation for alternative water injection, and (3) Preparation for venting from the Primary Containment Vessel (PCV).

In this section, the difficulties which were faced in the above three tasks are introduced taking the case of the Unit 1.

(1) Restoration of the instruments and lights in the MCR

In order to recover the instruments in the MCR, batteries and cables were collected from the warehouses and cars on the site. Then the collected batteries were connected to the vital instruments and at about 21:30 on March 11, the voltage from the RPV water level gauge was successfully read first on Unit 1 and secondly on Unit 2. A picture in Figure 3 taken in the MCR shows a lot of batteries connected to instruments. Note that batteries for Unit 3 could survive

from the flooding and the reading of the vital plant parameters could be maintained for about 30 hours. Temporary lightings were also set up in the MCRs using small generators at around the same time.



Figure 3 - Batteries connected to instruments in the MCR

(2) Preparation for alternate water injection

Unit 1 was prioritized as the most urgent since it didn't have any sufficient water injection methods available after the tsunami attack. In the Emergency Response Center (ERC) on the site, alternative methods of coolant injection using fire protection systems and fire engines started to be prepared in the evening on March 11.

In the field, recovery work proceeded under the hardship with several interruptions of work due to many aftershocks and large-scale tsunami warnings. Lack of lightning and communication tools prevented effective activities, and furthermore, debris and holes on the road interfered with the traffic of people and service vehicles (see pictures in Figure 4). Under such situations, some field workers worked hard for lining up alternative water injection line, and others walked down the field in order to find intact facilities. As a result of the field survey, the ERC restoration team found that electric panels (metal-clad switchgears and power centers) for Unit 1 all were flooded and unusable, while one of the Unit 2 power centers was usable.

A new plan was established to use Standby Liquid Control system (SLC) as a candidate by connecting the power supply vehicle into that intact power center. However, this attempt finally failed because the cables connecting between the vehicle and the power center were damaged by the hydrogen explosion, which occurred in Unit 1 at 15:36 on March 12.

Diesel-driven fire protection pump was expected as an alternative water injection method and was ready to inject water after depressurizing the RPV at about 20:50 on March 11, but it became unavailable due to ground fault of starter motor before it had a chance to inject water.

These recovery efforts continued overnight, and finally fresh water injection was commenced for Unit 1 in the early morning by using a fire cistern and fire engines. However the amount of fresh water injected was limited and it was not enough for safely cooling down the reactor.

In addition to the restoration efforts for fresh water injection, the preparation for the sea water injection was conducted at the ERC and the field. A main condenser back-wash valve pit of Unit 3, which was closer to the units and at a higher elevation than the sea, was expected as

a water source and the temporary hoses were laid down, however, this line up was also damaged beyond use by the hydrogen explosion. After a while the injection line from the pit was reestablished, three fire engines were connected in series from the pit to the fire hydrant and the sea water injection was finally started at 19:04 on March 12.



(a) Debris on the road

(b) Tank floated by the tsunami

Figure 4 - Hardship in the field

(3) Preparation for venting from the PCV

Another significant issue was how to reduce the containment pressure. Manual operation for PCV venting through the reinforced vent line became necessary under the SBO condition, but no procedures existed for such an extreme situation. Piping & instrumentation diagrams, Accident Management (AM) procedures, valve diagrams, and other documents started to be checked up in advance for developing a method to line up the hardened venting line without power sources.

At 9:04 on March 12, after the completion of local people's evacuation, the field work started to line up the venting line in the reactor building. In the MCR of Unit 1 and 2, it was decided to set up three teams consisting of two senior shift operators each, since complete darkness inside the reactor building would have made it impossible to execute the task by one person, high radiation dose was expected, and retreating due to aftershock was anticipated. The first team entered the reactor building and successfully opened a motor-operated (MO) valve on the second floor. The second team also entered the reactor building and tried to open an air-operated (AO) valve on the basement floor inside the torus room. However, on the way to the air-operated valve, the team was forced to return back to the MCR because high radiation dose was indicated on the survey meter in the torus room.



Figure 5 - Self-contained breathing apparatus for manual valve operation

Manual operation of AO valves was abandoned. Opening the AO valves was eventually achieved by connecting a temporary air compressor to the air supply line. At 14:30, the decrease in the PCV pressure for Unit 1 was observed and PCV venting was finally successful. This section could be summarized that several implementable countermeasures/ modifications that could have reduced the damage at the unforeseeable accident were not readily available to mitigate the accident.

5. Analysis of Key Factors in the Plant Behavior

It is about a year since the accident occurred and various restoration works are still going on the site in order to bring the damaged plants to more stable status and prepare for defueling and decommissioning of the units. In parallel with the stabilization works, event investigation and analysis has been continuously conducted.

In this section, the key factors which led Unit 1 to 3 to core damage are discussed through the analysis on the plant response and then the lessons learned are extracted.

Note that the investigation is still under way and the following discussion is based on the current understanding of the event.

5.1 Analysis on the Plant Response

At Unit 1, due to loss of DC power supply to the control logic caused by the tsunami, the IC system was automatically isolated and lost its function, that meant the function of high pressure core cooling was lost. Afterwards, reactor water level decreased in a short time and reached the top of the active fuel region, leading to the core damage. During this period of time, it was not possible to understand vital plant parameters such as water level and pressure and thus the operators and the emergency response team could not understand the status of the IC operation.

At Unit 2, the function of high pressure core injection was maintained by RCIC continuous operation for about three days, which contributed the decrease in the decay heat. However, after the RCIC tripped, reactor water level started to decrease. Although the alternative water injection method using fire engines became available in less than 1.5 hours from the RCIC trip, this function of low pressure water injection could not work in a timely manner because reactor depressurization by using Safety Relief Valve (SRV) did not start immediately. And when reactor pressure was successfully decreased by SRV operation, then this alternative water injection method using fire engines could not work immediately due to fuel shortage. In addition, the decrease in RPV water inventory due to outflow of steam to the suppression chamber during reactor depressurization worsened core cooling status and consequently the reactor was led to core damage.

At Unit 3, the RCIC and HPCI continued to supply water for about 35 hours after the tsunami. During this period of time, the preparation for the low pressure water injection using a Diesel-Driven Fire Pump (D/D FP) was conducted. However, since the reactor pressure was much higher than the discharge pressure of D/D FP, the switch from the water injection by the HPCI to the D/D FP was not achieved immediately. Consequently, core cooling status became worse in the same way as Unit 2 and core damage could not be prevented.

Following the core damage, significant amount of hydrogen was generated in the reactor and it leaked out to the surrounding reactor buildings. Furthermore, the accumulated hydrogen caused the explosion in Unit 1 and 3 reactor buildings.

5.2 Lessons extracted from Plant Response Analysis

Several lessons learned are extracted from plant response analysis. In order to secure reactor cooling function and prevent core damage even under any severe accident conditions, it is important to tackle the following issues:

1. To immediately provide a measure for high pressure water injection. (The high pressure water injection system did not function as designed at Unit 1)
2. To provide a measure for reactor depressurization before losing the function of high pressure water injection. (Providing such measures at Unit 2 and 3 required cumbersome operations including the installation of temporary batteries)
3. To provide a stable measure for low pressure water injection function at the time of reactor depressurization. (Water injection by the fire engines as a temporary measure was conducted at Unit 1 to 3 with a lot of difficulties.)
4. To provide a reliable measure for PCV venting. (Manual venting operations due to the loss of all AC/DC power at Unit 1 to 3 were conducted with a lot of difficulties due to deteriorated work conditions)
5. To provide measure for recovering the ultimate heat sink cooling function using seawater. (Unit 5 and 6 at 1F and all the units at 2F were brought to cold shutdown with the restoration of the seawater cooling function by installing temporary power sources and temporary pump motors.)
6. To provide monitoring functions necessary to implement the above measures and understand the plant status. (Unit 1 and 2 at the 1F site lost the power supply to the monitoring instruments due to the loss of both AC and DC power sources)

6. Countermeasures for Preventing Core Damage

Given the impact on the facilities, the reality of the recovery works and the lessons extracted from plant response analysis respectively discussed in the Section 4, 5 and 6, the countermeasures applicable for existing nuclear power plants are discussed in this section. The countermeasures are categorized into the following three Tiers:

Tier 1:

From the viewpoint that tsunami is the direct cause of the accident, to take thorough tsunami countermeasures for safety significant facilities to maintain the water injection and cooling function, in addition to the countermeasures to mitigate tsunami force directly

Tier 2:

To take flexible measures with enhanced applications and mobility that can prevent core damage in advance, based on the assumption of multiple equipment failures and loss of functions (due to the “simultaneous loss of all AC power and DC power over a long period of time” and “loss of heat removal function of seawater cooling system over a long period of time”) that were experienced in Fukushima accident

Tier 3:

To prepare further countermeasures for mitigating the influences assuming the case that core damage occurs

It is clear that the continuous water injection for removing residual heat without interruption is essential. A schematic figure which describes the success path for cooling and heat removing for the reactor is shown in Figure 6. In order to achieve each step surely, the following main countermeasures can be proposed under the Tier 1 to 3:

Tier 1:

- To take measures for protecting the nuclear power site and the buildings there from flooding, Ex. installation of tide embankment and tide barriers

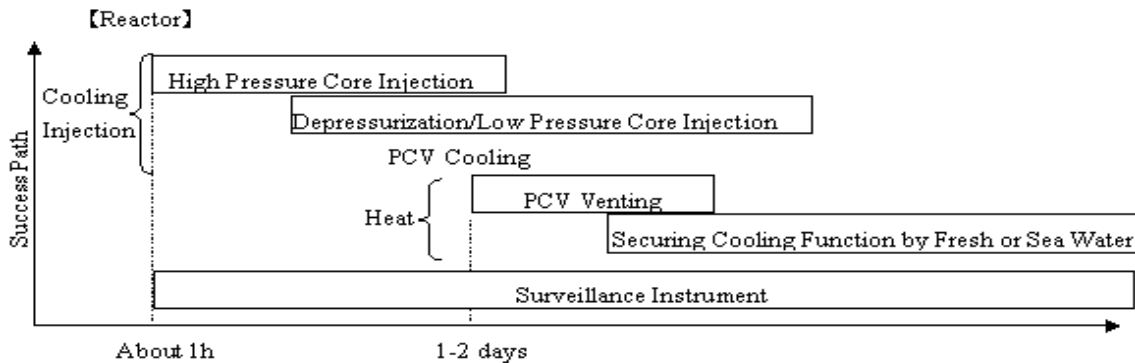

Figure 6 - Success path for cooling and heat removal for reactor core

- To take thorough measures for flood protection especially for the vital water injection facilities for the reactor core and spent fuel pool (SFP), the associated electric power supply facilities and the facilities for ultimate heat sink, Ex. waterproofing of the vital pump rooms, the associated battery rooms and the electric panel areas
- To install the spare motors of emergency sea water cooling system and intermediate cooling system for residual heat removal system (RHR)

Tier 2:

- To develop measures to manually start up the high pressure injection system such as RCIC and HPCI in the field
- To prepare the mobile power vehicle with transformers, circuit breakers and cables at a high and safe place for use of both the motor-driven high pressure water injection pump, such as the SLC, and the motor-driven low pressure water injection pump, such as FP and make-up water condensate system (MUWC)
- To prepare measures for opening valves and other components for reactor depressurization, Ex. preparation of portable batteries
- To prepare fire engines at a high and safe place as backup function of low pressure water injection in addition to D/D FP, motor-driven FP and MUWC and to make sure in advance that those fire engines can actually pump up water from the sea or other water sources with the practical procedure
- To take measures for more reliable operation of PCV venting by modifying the system, Ex. enabling manual operation of AO valve, and by storing portable air compressors, generators and nitrogen cylinders at a high and safe place
- To prepare a set of the alternative submerged pump and heat exchanger with independent power source on the truck as a backup facilities for RHR
- To ensure the long time use of instruments for vital plant parameters by preparing mobile power vehicles, portable batteries and chargers

Tier 3:

- To prepare measures for exhausting accumulated hydrogen in the reactor building to the environment to mitigate influence of core damage, Ex. venting at the top of reactor building and opening the blow out panels

In addition, the common and essential countermeasures are proposed based on the experiences of Fukushima accidents as follows:

- To build the hazard-resistant emergency response building; without newly built seismic isolated building, that was built at the 1F site as a countermeasure taken after the 2007 Niigata Chuetsu Oki Earthquake, the post-accident activities could not have been carried out
- To prepare mobile heavy equipment for efficient debris removal
- To prepare sufficient amount of diversified communication tools, lighting tools and health protection equipment

Conclusions

TEPCO realized through the event investigation and analysis process that it would be important to carefully consider the robustness of current design of nuclear power plants and emergency preparedness against beyond design basis events that could lead to common cause failures regardless of their assumed probability demonstrating a continuous learning organization. In order to prevent the recurrence of such a severe accident and enhance, it is very important to share this lesson among the nuclear industry in the world, to develop appropriate countermeasures and surely implement them.

As the further event investigation and analysis goes forward, the results will be communicated to the public in a proper manner.

Nomenclature

<i>AM</i>	<i>Accident Management</i>
<i>AO</i>	<i>Air Operated</i>
<i>D/D FP</i>	<i>Diesel-Driven Fire Pump</i>
<i>EDG</i>	<i>Emergency Diesel Generator</i>
<i>ERC</i>	<i>Emergency Response Center</i>
<i>HPCI</i>	<i>High Pressure Coolant Injection system</i>
<i>IC</i>	<i>Isolation Condenser</i>
<i>MCR</i>	<i>Main Control Room</i>
<i>M/C</i>	<i>Metal Clad</i>
<i>MO</i>	<i>Motor Operated</i>
<i>MUWC</i>	<i>Make-up Water Condensate System</i>
<i>NPS</i>	<i>Nuclear Power Station</i>
<i>O.P.</i>	<i>Onahama Point</i>
<i>PCV</i>	<i>Primary Containment Vessel</i>
<i>RCIC</i>	<i>Reactor Core Isolation Cooling system</i>
<i>RHR</i>	<i>Residual Heat Removal System</i>
<i>RPV</i>	<i>Reactor Pressure Vessel</i>
<i>SBO</i>	<i>Station Black Out</i>
<i>SFP</i>	<i>Spent Fuel Pool</i>
<i>SGTS</i>	<i>Standby Gas Treatment System</i>
<i>SLC</i>	<i>Standby Liquid Control System</i>
<i>SRV</i>	<i>Safety Relief Valve</i>
<i>1F</i>	<i>Fukushima Daiichi Nuclear Power Station</i>
<i>2F</i>	<i>Fukushima Daini Nuclear Power Station</i>

References

- [1] TEPCO, “Fukushima Nuclear Accident Analysis Report (Interim Report)”, http://www.tepco.co.jp/cc/press/betu11_j/images/111202c.pdf, 2011 (in Japanese)
- [2] TEPCO, “Submission of a report on the operation of the plant based on the plant data etc. of Fukushima Daiichi Nuclear Power Station at the time of the earthquake to Nuclear and Industrial Safety Agency, Ministry of Economy, Trade and Industry”, Press Release, <http://www.tepco.co.jp/en/press/corp-com/release/11052412-e.html>, 2011
- [3] TEPCO, “Initial Response of Tohoku-Chihou-Taiheiyo-Oki Earthquake at Fukushima Daiichi and Fukushima Daini Nuclear Power Station”, Press Release, <http://www.tepco.co.jp/en/press/corp-com/release/11081015-e.html>, 2011

THE JAPANESE EMERGENCY RESPONSE TO THE ACCIDENT

Toshio FUJISHIRO

RIST, Special Advisor, former NSC Special Committee, fujisiro@tokai.rist.or.jp

Abstract

In the Fukushima Daiichi Nuclear Power Plant Accident, emergency response was conducted against massive release of radioactive materials under very difficult situation caused by huge earthquake and Tsunami. The system for nuclear emergency including information network, local emergency center, radiation monitoring system were severely damaged and the emergency procedures were not able to be conducted as prepared. Under this difficult condition, severe radiological effect to the people was prevented by early start of evacuation measures. In this report, development of Japanese nuclear emergency program is described with historical background, and the emergency response actually taken to the accident are introduced. The lessons learned and current activities for better emergency response program are also summarized.

Keywords

Emergency response, Fukushima, Nuclear Accident, Earthquake, Tsunami

Introduction

Emergency preparedness is a vital component to constitute the final level of defense in depth. Japanese emergency response program has been developed reflecting the lessons learned from severe accidents abroad and JCO accident occurred in Japan in September 1999. Local operation centers (Off-site centers) were constructed near every nuclear power plant (NPP) site and connected by communication network to the Emergency Response Headquarter in Tokyo. Comprehensive drill by the government has been conducted every year since 2001.

The emergency response taken to the Fukushima Nuclear Power Plant (NPP) Accident was the first case executed under duplicated influences of severe nuclear accident and huge natural disaster. It was generally regarded so far that NPP have enough durability against natural hazard like earthquake or tsunami by robust safety design and operation. The nuclear emergency procedure under the influences of huge earthquake and tsunami was therefore actually not considered in the emergency program, and many of the procedures prepared were not applicable at least in the early stage of the response.

Under this highly confused situation, communication between TEPCO Tokyo headquarter and Fukushima on-site emergency center was kept intact. Evacuation area was decided by the government before radioactive material release based on the information of accident conditions transferred through the TEPCO communication line. Evacuation was started in many cities based on the information obtained through TV due to the difficulty of information transfer by phone or fax. Early start of evacuation prevented high dose exposure or contamination, though the experience left many hard lessons. Large release of radioactive materials, especially Cs-134, 137, caused wide area contamination which left the problem of low-level external exposure and internal-exposure though ingestion. Long term action is underway including monitoring, aftercare of the people evacuated, decontamination and mitigation of non-radiological influences.

1. Emergency Program in Japan

1.1 Historical background

Emergency program in Japan has been developed step by step reflecting the experience of severe nuclear accidents as seen in other countries. First large step for establishing an emergency program for nuclear started motivated by the impact of TMI-2 accident occurred in March 1979. Nuclear Safety Commission (NSC) established the Technical Advisory Group in Nuclear Emergency within NSC as a national technical group to support the emergency activities of local government shortly after the TMI-2 accident, and published a guide for emergency preparedness in 1980. Based on this NSC guide, emergency planning zone (EPZ) was defined, and emergency program including communication network, radiation monitoring, radiation emergency medicine, supporting system like SPEEDI for real time prediction of expected doze. Chernobyl accident in 1986 gave a large impact, but the major action was to strengthen the prevention and/or mitigation of severe accident by introducing the severe accident managements (SAMs). **(Slide 3)**

JCO accident which is a criticality accident occurred in a small processing plant of nuclear fuel material in Tokai-mura in November 30, 1999, gave a very large impact. Though the release of radioactive material was minimal, neutron radiation was released out of site, 3 workers were exposed to high radiation levels to death or severely injured, about 150 people close to the plant were requested to evacuate, and about 200,000 people in 10 km area were advised to remain indoors. **(Slides 4-5)** Shortly after the accident, the national government issued the Special Law of Emergency Preparedness for Nuclear Disaster, and NSC modified the guide for nuclear emergency. Based on the special law, local emergency centers (Off-site Centers, OFC) were constructed in the vicinity of every nuclear facility sites, and Technical Supporting Network connecting Government Emergency Response Headquarter and OFCs was prepared. Framework of radiation emergency medicine were also strengthened. Drills for nuclear emergency including the comprehensive nuclear emergency drill by national government, drills by local governments and operators have been conducted every year since 2001.

1.2 Current Framework of Nuclear Emergency Program

Basic Law for Emergency Preparedness and Special Law of Emergency Preparedness for Nuclear Disaster are the basic laws constituting the legal framework. Based on these laws, National Basic Program and NSC Regulatory Guides are established by the government. Emergency plans are prepared as those of national government, local governments and nuclear installation operators responding to the requirements of the basic laws and NSC guides. **(Slides 6-7)**

The basic system of operation is defined as illustrated in **Slide 8**. Every license holder of nuclear installations is requested by law to make a notification to the government, METI or MEXT, when an unusual condition is detected. The action levels for notification and emergency action are defined by the dose measured at site boundary and by events in the facility as shown in **Slide 9** and **Slide 11**. When the severity of the unusual condition reached the emergency levels, Minister of METI or MEXT have to report to the Prime Minister and the nuclear emergency is declared based on the decision of the Prime Minister. Then the emergency actions, evacuation or others, are decided based on the action levels as listed in Table 2, and transmitted to the people through local government.

The Emergency Planning Zone (EPZ) is defined in the NSC guide as listed in **Slide 13**. Recommended size of EPZ for NPP is decided as 8 to 10 km in radius presuming the release of radioactive materials from the site much larger (about 10 times) than the release in a hypothetical accident in siting evaluation in which 100% release of rare gas and 50% of Iodine of total inventory to the containment vessel is assumed as the worst possible accident.

1.3 Supporting system for nuclear emergency

After the JCO accident emergency preparedness is highly strengthened and many supporting system was constructed. Emergency centers (Off-site Centers) were constructed near every NPP sites. **(Slides 15-17)** The Off-site Center is facilitated with computer terminals directly connected to the Government Emergency Headquarter in Tokyo and designed to function as a local emergency headquarter. Stationary facilities for radiation monitoring (monitoring posts) were constructed around the NPP sites and the data are sent to the Monitoring Center constructed near the Off-site Center. **(Slide 18)** Around Fukushima NPP sites, 24 monitoring posts were in operation. Technical supporting systems, SPEEDI and ERSS, were developed. SPEEDI is a system for performing real-time prediction of environmental and radiological consequences. **(Slide 20)** ERSS is a system to provide monitoring data of NPP system parameters and to predict accident progression by analytical tools. Both systems are connected to the Government Emergency Headquarter and every Off-site Centers through emergency network. **(Slide 21)** The system for radiation emergency medicine is established for urgent treatment of workers and local residents exposed in accidents. Hospitals are specified for the treatment of exposed patients depending on the stage of necessary cares.

1.4 Drills conducted before the Fukushima accident

Nuclear emergency drill is very important for the training of the emergency staffs and to establish a system for effective emergency actions. Comprehensive Nuclear Emergency Drills were conducted once a year since 2001 in collaboration with the national government, local governments, license holders and supporting research organizations. In Fukushima the comprehensive drill was conducted in October 2008 with about 2,650 participants dispatched from 96 organizations. Total scope of emergency procedure were conducted in the Fukushima comprehensive drill including level 1 and level 2 notification, declaration of emergency by Prime Minister, direction of measures based on a pre-determined scenario of core destruction accident. In addition local governments and license holders performs at least once a year at each site. **(Slides 23-25)**

2. Emergency Response to the Fukushima Accident

2.1 Emergency action taken

Emergency action was taken under very severe conditions affected by earthquake and Tsunami. Information network was damaged by earthquake or by loss of electric power supply. Major functions of local emergency center (OFC) were also lost by the damage of information system. As the location was about 5 km from Fukushima NPP site, evacuation from the OFC was requested later. Many of the emergency staffs were occupied with the activities against natural disaster and not able to join to the nuclear emergency activities. Other difficult condition was that the scale of the accident was much larger than the case assumed in the emergency preparedness. Core melt and containment vessel leak at three NPPs at Fukushima Daiichi site resulted in large release of radioactive materials out of site which was larger than that assumed in the emergency program.

Monitoring is one of the most important activities needed in nuclear emergency. But most of the monitoring posts were damaged by earthquake and Tsunami, or enabled by loss of electric power supply. Measurements by monitoring car with portable instruments was initiated, but early stage monitoring was quite limited due to the road conditions damaged by the earthquake.

Due to the damage of off-site center function and the information network, major

communication was performed between the on-site emergency center at Fukushima Daiichi site and TEPCO Tokyo headquarter office. Government-TEPCO Integrated Emergency Office was temporary established in TEPCO and functioned as an additional emergency operation center.

(Slide 28)

Emergency technical support systems, SPEEDI and ERSS, were not effectively utilized. Results from SPEEDI analysis were provided in response to the request of government offices, but not referred to since the analysis was based on an assumed source term value. Later, the results based on evaluation from monitoring data were released and used as the reference for the long term action. **(Slide 30)**

Decision for evacuation area was done based on the accident conditions. First government instruction for evacuation was for 3 km area decided in response to the loss of core cooling, then changed to 10 km, full EPZ area, in response to CV pressure increase, and finally expanded to 20 km by the report of hydrogen explosion. **(Slides 27-29)**

Damage of information network and other difficult conditions prevented smooth transfer of the government instruction to the residents. In many cases, action was initiated by the decision of city mayors based on TV information. Due to the expansion of evacuation area, sheltering places had to be changed after the initial evacuation action. Early decision of evacuation area before the release of radioactive materials and early start of evacuation action prevented high-dose exposure or contamination, though the people faced to very hard conditions in evacuation procedure. The fact that not a few hospitalized patients died during transportation or at sheltering places due to lack of medical care is also regarded as one of the issues to be solved.

Regarding iodine medication, tablets of stable iodine were prepared at prefecture and city offices. However, as clear instruction was not dispatched by the emergency center, distribution was dependent on the decision of city offices. A few contaminated TEPCO workers and several inhabitants of contaminated area were sent to NIRS and examined. Screening of people moved from evacuation areas was performed.

2.2 Long term action needed

Large release of radioactive materials, especially Cs-134, 137, caused wide area contamination which left the problem of low-level exposure and food restriction. **(Slides 34-35)** Long term action is underway including monitoring, aftercare of the people evacuated, decontamination, mitigation of non-radiological influences. Major long term action needed are listed as follows.

(1) Environmental monitoring

- Detailed monitoring of near-site and wide area contamination both for land and sea area
- Monitoring of agricultural food and drinking water.

(2) Aftercare of inhabitants

- Support of living and health care for the people evacuated from the contaminated area
- Support of migration from or returning to the home town
- Medical follow-up.

(3) Information provision

- Public information through TV and other information medias
- Provide detailed information through internet.

(4) Decontamination

- Decontamination of areas for resumption of farming and other activities
- Decontamination of affected areas to decrease population dose.

(5) Mitigation of non-radiological consequences

3. Lessons Learned

Major subjects of lesson learned from the experience of emergency response to the Fukushima accident are summarized as follows.

- (1) Severe accident occurred in multiple NPPs resulted in the release of radioactive material much larger than expected in the emergency program. Program must be revised to meet the situation.
- (2) Attack of huge earthquake and loss of electric power supply destroyed the function of the prepared emergency systems, including off-site center, radiation monitoring system and information networks. The systems and procedures should be strengthened for more robust one.
- (3) Long term action became very important due to large release of long life FPs (Cs-134, 137). Studies are needed to respond to long term actions including decontamination of the environment.
- (4) Non-radiological effects (mental and social influences) were not prevented, and long term care should be needed.

4. New Steps for Better Emergency Response

Many activities have started to strengthen the nuclear emergency preparedness reflecting the lessons learned from the Fukushima NPP accident. The following is the current status of major activities.

- (1) Revise NSC guide for emergency planning and strengthen national and local emergency program
 - expand planning zone: from 10 km to 30 km
 - apply IAEA guides: introduce PAZ and UPZ
- (2) Strengthen supporting systems and environment for emergency action
 - establish robust radiation monitoring system, diversified information network, multiple evacuation route
 - establish robust off-site center and its substitute facilities
- (3) Modify framework for emergency action
 - refurbishment of government system for nuclear emergency are planned in the reorganization of national regulation framework.

Summary

Development of emergency preparedness for nuclear accident in Japan started by the impact of the TMI-2 accident and enhanced by the Chernobyl accident. The program was highly strengthened by the impact of JCO accident in which first emergency response was activated in Japan, and special law for nuclear emergency was established just after the accident. Emergency centers (Off-site centers), preparation were constructed near every NPP site, and emergency drills have been conducted frequently.

In Fukushima NPP accident, huge earthquake and resulting large FP release caused many difficult situation in emergency actions, but radiological effects to the public were effectively prevented by early start of evacuation before FP release. The experience of the Fukushima NPP accident also gave us many lessons in emergency planning, and action has started for better emergency preparedness.

Long term actions both for radiological and non-radiological influences caused by the wide area contamination of the environment are the next big issues to be solved.

References

- [1] Special Law of Emergency Preparedness for Nuclear Disaster, December 1999.
- [2] NSC Safety Guide, Emergency Measures for Nuclear Installations, May, 2007.
- [3] Report of the Japanese Government to the IAEA Ministerial Conference on Nuclear Safety, June 2011.
- [4] NISA report at the side event on the “Fukushima Daiichi Accident and Initial Safety Measures Worldwide” in IAEA, April 4th, 2011.
- [5] Interim Report of National Committee for Study and Investigation of the Fukushima Nuclear Plant Accident, December 2011.

FUKUSHIMA DAI-ICHI'S RADIOACTIVE SOURCE TERM AND RELEASE IN THE ENVIRONMENT

O. Isnard, E. Raimond, D. Corbin and J. Denis

IRSN's Emergency Centre

Summarized and presented by

G. B. Bruna

Sci. Dir., IRSN

Abstract

The paper is a reduced version of the full paper presented at the Eurosafe 2011 Forum in Paris [1] by the IRSN's *Emergency Centre* team. It underlines the methodology adopted to assess the state of the different units of Fukushima Dai-Ichi site during the follow-up of the emergency situation faced by Japan in March 2011, and summarizes the main conclusions of the source term evaluation, carried-out by the Emergency Centre, which was activated after the event, and immediately started delivering expertise on the accident and its radiological consequences.

Introduction

An earthquake of magnitude 9 and a subsequent massive tsunami hit the eastern Japan coasts on March 11 2011. The Fukushima Dai-Ichi Nuclear Power Plant was severely affected and caused a radiological emergency. The generalized station blackout engendered severe damage in the reactor units and massive atmospheric releases of fission products from March 12. The situation was immediately brought at an international level, and the IRSN's Emergency Centre activated.

The paper presents the evaluation of the atmospheric releases (source term) carried-out by the IRSN's Emergency Centre relying on the available information on the four main-concerned reactor states and the behaviour of the radionuclides inside the core and in the buildings, as well as. Simulations and/or observations of the meteorological conditions allowed predicting the atmospheric conditions, which enabled simulating the dispersion of the fission products adopting different models in regard of the spatial scale.

Eventually, comparisons with measurements (dose rate and deposition) are presented.

1. Source term evaluation

The IRSN's Emergency Centre is to evaluate the actual and potential atmospheric releases of contaminants from the plant, and to assess their radiological consequences, relying on the information on the affected nuclear facilities, as soon as it is made available.

In this section, the methodology adopted by the Centre to assess the source term is briefly described.

1.1 Source term assessment during the operational response

Activated very few hours after the earthquake, the IRSN's Emergency Centre strictly applied to the Fukushima Dai-Ichi case the methodology settled for nuclear emergency in France. The installation assessment team collected all available technical information to appreciate the situation of the units and to forecast the likely evolution of the situation. The assessment of the radioactive releases to the atmosphere was thus undertaken. So, the radiological

consequences assessment team was able to estimate the atmospheric dispersion, the ground deposition and the radiological consequences at different scales (local, regional and worldwide).

Although Japanese Authorities (NISA) and utilities (TEPCO) provided information on their web sites, getting a clear vision of the events occurring in the Units 1-4 was extremely difficult.

The IRSN's team realized quite quickly the incumbent risk of core melting as a consequence of the possible failure of water injection, even if precise information on the availability and the operability of core cooling systems on each unit was dramatically missing. Before the explosion of the Unit 1 building, none of the environment radioactivity measurement claimed large release, even after the first venting of the containment for Unit 1.

In parallel to the analysis of the situation in Japan, the IRSN's installation assessment team reviewed the publicly available data on severe accident transient of BWR Mark I reactor type and exchanged with other Emergency Centres worldwide and partners in risk assessment research projects. The severity of the situation in case of a long-lasting blackout was promptly realized. The following necessary and urgent actions were identified to protect the systems:

- The primary circuit had to be discharged into the reactor containment via the suppression pool to control the pressure: cold water injection could have prevented from a fast increase of the containment pressure,
- Without actuation of the emergency cooling, the water in the suppression pool would have progressively warmed-up and started boiling,
- The reactor containment pressure would have increased quickly because of the very small size of the containment, compared to current PWRs,
- The containment should have been vented periodically to avoid rupture,
- In case of core dewatering and melt, the contaminants would have been released from the fuel to the primary circuit, then to the reactor containment through the suppression pool and eventually partially released to the environment via the containment venting line (if any),
- The large amount of hydrogen produced by the clad oxidation during the melting would have caused a very high risk of hydrogen combustion in the reactor building in case of leakage from the containment vessel,
- The hydrogen combustion inside the secondary containment could have damaged the structures, threaten the pool structures, destroyed the roof and create a bypass to the turbine hall,
- Publicly available calculations were predicting very high release in such conditions.

The assessment methodology adopted relied on transient analysis and on the dominant risk evaluation through PRA. The risk of damage for the spent fuel pool in case of hydrogen combustion in the reactor building was also identified with a cliff edge effect on the release in case of fuel dewatering.

The explosion of Unit 1, quickly identified as a hydrogen explosion, testified that the core had already started melting. In terms of release, it was obvious that part of the gaseous radioactive elements (noble gas, iodine ...) had already spread out in the environment. The explosions in Unit 2 & 3 buildings definitely demonstrated how predictable is the sequence of events for these plants in case of long-term station black-out.

IRSN's Emergency Centre evaluated the order of magnitude and kinetics of atmospheric releases by the methodology described hereafter. This methodology was mostly based on the adaptation of existing tools and knowledge for French PWRs. The Fukushima Dai-Ichi BWR core inventories (radioisotope initial mass and activity in Units 1,2,3) were evaluated in a simplified way extrapolating linearly from French PWR core inventories.

Because of the poor knowledge and understanding of the events which were going on the site, it was assumed that the three damaged units could be roughly represented as a single damaged unit with the following features:

- A radionuclide core inventory equal to the cumulated inventories of reactors 1, 2 and 3,
- An core melting of 45%, on the average,
- A continuous leakage from the containment of 0,5 %Vol/day,
- 12 periods of major release (30 minutes each) with a flow rate equal to 230 %Vol/day; the precise time of each release was estimated via the dose rate peaks measured at the site stations located in the vicinity of the reactors,
- A containment failure engendering a 60 %Vol/day flow rate,
- A retention factor of 10 for the aerosol in the suppression pool.

The calculations performed with the French 900 MWe PWR model provided the release distribution and duration summarized in the Tables 1 & 2.

Table 1 – Repartition of radioactive elements after 4 days of release

Form	Repartition of the initial core inventory after 4 days of release
Noble gases	40% in the environment, 60% in the containment (100% in the environment would have been more realistic)
Iodines (gaseous form)	0,02% negligible
Iodines (aerosol form)	4% in the environment, 1% in the building, 5% in the vessel or drywell, 90% in the wet wells
Aerosols (others)	4% in the environment, 1% in the building, 5% in the vessel or drywell, 90% in the wet wells

Table 2 – Order of magnitude of release after 4 days of release

Form	Total release
Noble gases	3.7 E18 Bq
Iodine	4.6 E17 Bq
Caesium	5.9 E16 Bq
Tellurium	2.2 E17 Bq

Assessment of the consequences of the spent fuel pool dewatering was also performed and comparison with environmental dose monitoring results provided evidence that the event was not likely to have occurred.

1.2 Source term assessment after the operational response

IRSN's Emergency Centre stepped down 6 weeks after the first call, but it lasted working to improve the quality of the preliminary estimations of the release. Some additional evaluations were carried-out to confirm the source term assessment. This activity, which is still ongoing, can be summarized as follows:

- Preliminary identification of the radioactive release periods for each Unit 1, 2 and 3, to evaluate a set of release peaks (temporal aspect) from the information available from the Fukushima Dai-Ichi site.
- Improvement of identification of the radioactive release periods for each unit.
- Improvement of the release amplitude and composition estimation, based on dose monitoring. As an example, Figure 1 shows, the release of I-131 into the atmosphere and a comparison with the evaluation done by Chino [reference] as well.

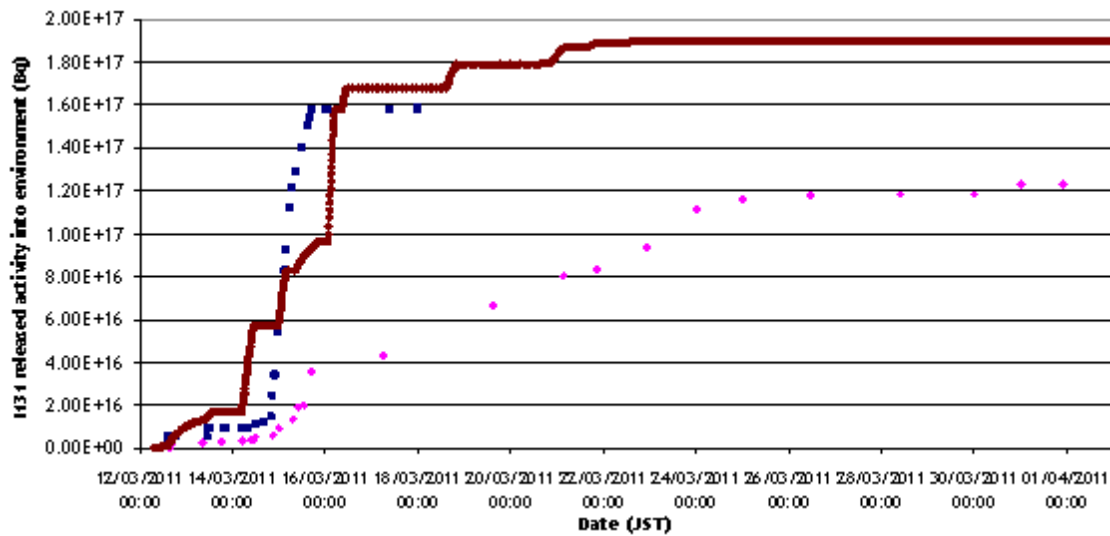

Figure 1 - Evaluation of I-131 activity released in the environment. Estimation of Chino [2] (pink), Estimation of Bannai [3] (blue) and IRSN (red)

2. Meteorology

The meteorological data adopted to evaluate the transport of the radionuclides into the atmosphere depend on the scale. In the vicinity of the nuclear installation, the observed meteorological data on site are combined with the radar observations provided by the Japan Meteorological Agency for the rain. Concerning the evaluation at the scale of Japan, weather data of the European Centre for Medium-Range Weather Forecasts (ECMWF) is used. At the local scale, the ECMWF meteorological data can also be used.

2.1 Observed meteorology in the vicinity of the nuclear site

After the March 11 earthquake and the following devastating tsunami, most of meteorological observation stations from the AMeDAS (Automated Weather Station Network) system of the Japan Meteorological Agency were out of use [3]. The station operated by TEPCO on the nuclear site of Fukushima Dai-Ichi was operating during the situation.

The rain is a key element in the process of atmospheric dispersion and more specifically in the process of deposition on the ground of the different radionuclides released by the reactors. The rain intensity is interpolated in space and time from radar measurements provided by the Japan Meteorological Agency. Figure 2a shows an example of rain images available during the situation at a frequency of 10 minutes and Figure 2b presents a spatial interpolation at 0.125° resolution made from this image. This interpolation is adapted to the spatial resolution of the weather forecast provided by ECMWF.

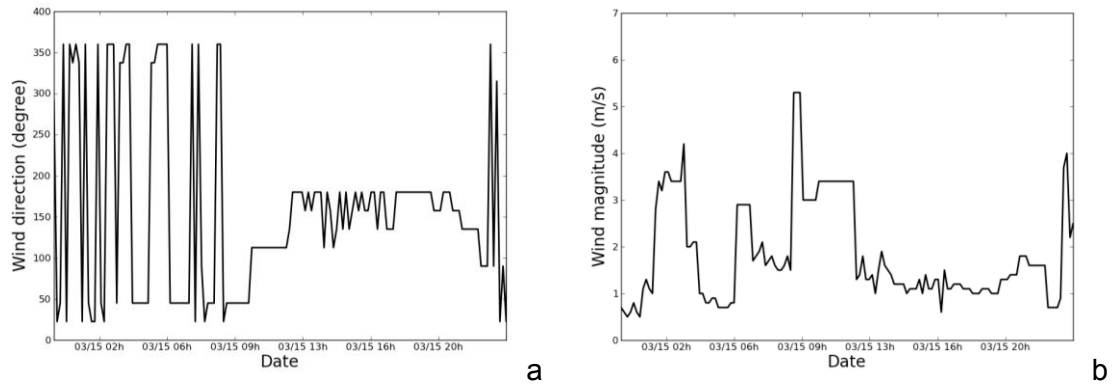

Figure 2 - Wind direction (a) and Wind magnitude (b) measured on the Dai-ichi station

2.2 ECMWF meteorological data

The meteorological data, which drive the atmospheric dispersion evaluation over Japan, comes from the ECMWF centre. The data were provided on a grid resolution of 0.125° (approx. 12 km) with time resolution of 3 hours from March 11 to March 26. Figure 3 shows the spatial extension of this meteorological data used to study the behaviour the radionuclides over Japan with the grid resolution.



Figure 3 - Spatial extension of the domain used to compute atmospheric dispersion over Japan.

3. Atmospheric dispersion model

3.1 Major events

From the environmental point of view, the major events affecting the site were:

- The core-melt of Unit 1 and its explosion at 15h36 JST March 12.
- The core melt of Unit 2 and, the subsequent venting operations and its explosion at 06h00 JST March 15.
- The subsequent releases from Unit 2 and Unit 3 which led to the contaminations in the Tokyo area.

3.2 Model of the atmospheric dispersion

In the vicinity of the nuclear site, a small scale atmospheric dispersion model can be adopted. The IRSN's Crisis Centre adopted the operational Gaussian puff model pX [4] which is conventionally widely adopted in the operational context because they are quite fast-running. They are also adopted because of their validation against atmospheric dispersion campaigns [5].

A more complex meteorological non-homogeneous in space, unsteady scenario was also used, relying on the observations from the TEPCO station for the wind and the radar measurements for the rain.

The atmospheric dispersion at greater distances requires a model able to account for some major mechanisms of the atmospheric dispersion at meso-scale or even larger. The operational full Eulerian 3D atmospheric dispersion model, IdX [6] was adopted by IRSN to evaluate the behaviour of the atmospheric releases of the different reactors at the scale of Japan.

3.3 Major events and their consequences

The core melt of Unit 1 started at 17h00 on March 11, the hydrogen explosion occurred at 15h36 on March 12. The early atmospheric releases were transported towards north and then towards the ocean. Most of the meteorological stations of the AMeDAS system and the SPEEDI, dose rate, measurement stations were out of use during this period. The only station which was able to detect the radioactive plume from Unit 1, was the one located in Minami Soma approximately 25 kilometres north from the nuclear site on the shore.

Figure 4 shows a comparison between the evaluated vs. measured dose rate at the Minami Soma monitoring station. An overall good agreement shows-up among the measurements and the numerical evaluations, except for a small time-shift of the latter ones.

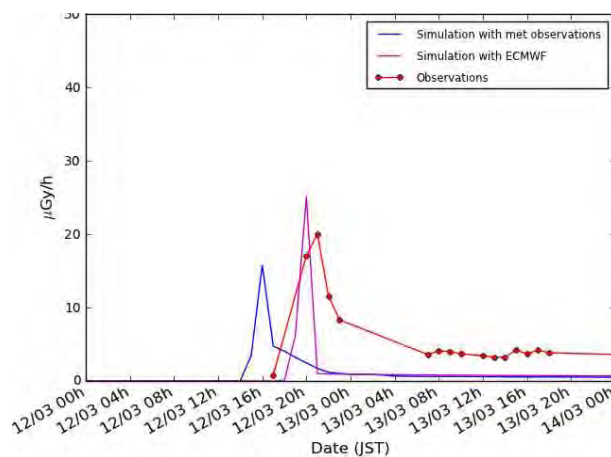

Figure 4: Comparison of the dose rate engendered by the Unit 1 release - at Minami Soma -

Within a domain of dozens of kilometres, the major contamination of the environment originated from the releases from Unit 2 - the core of which had already started melting on March 14 - after an explosion in the torus room of the PCV, on March 15.

The event and the subsequent venting operations - from midnight March 15 on - engendered massive atmospheric releases, which initially went south as shown in the Figure 5a, then progressively switched to the west (Figures 5b and 5c) and finally to north-west (Figure 5d) as

the wind direction changed. So that a wide area westward the site was impacted by atmospheric releases from Unit 2.

Shortly after 8 p.m., some heavy rains were detected moving from north-west towards the site (in the opposite direction of the plume). The major episode of rain occurred from 9 p.m. to midnight. The wash-out of the radioactive plume produced a large deposition in the environment.

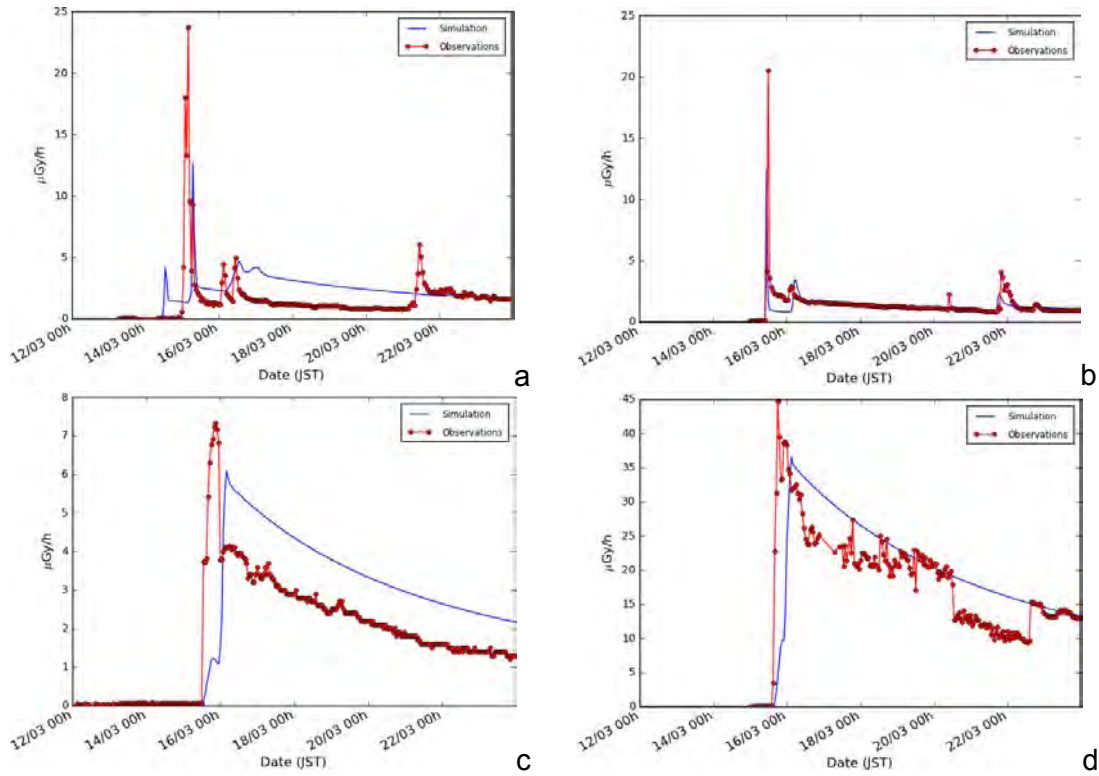
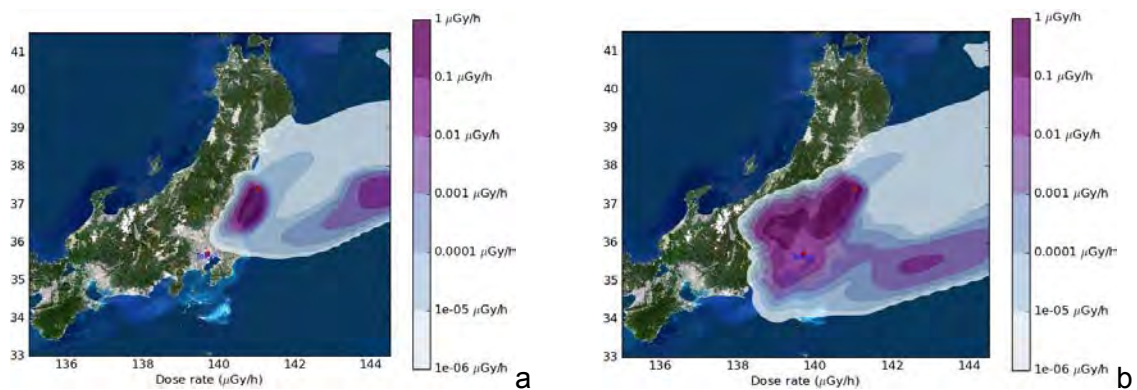
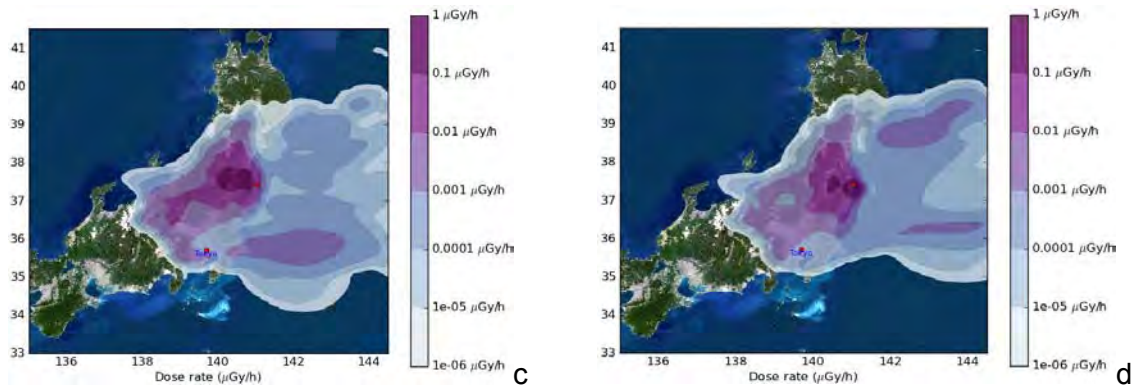

Figure 5 - Comparisons of the dose rate measured at the Iwaki (a), Kawauchi (b), Shirakawa (c) and Itate (d). stations located in the south, south-west and north-west of the site, respectively

The Tokyo area was impacted mainly by the releases from Unit 2. As shown in Figure 6, the dose rate first spread to the south region of Fukushima towards Tokyo, and then moved towards north-west in direction of Fukushima city and Itate. Figure 7 shows the comparisons among the simulation and the measurements provided by two stations located in Tokyo city centre and Hitachiōmiya (Ibaraki prefecture, north of Tokyo).





**Figure 6 - Plume dose rate computed, March 15, 03h00 (a) – March 15, 12h00 (b)
– March 16, 00h00 (c) – March 16, 03h00 (d)**

From March 19, subsequent still unexplained atmospheric releases were observed. The releases were transported first towards north-west, then west directly to the ocean. During the night of March 20, a large-scale meteorological structure transport back, towards Japan the fission products, which were over the ocean. From March 21 the Tokyo area is impacted again but with a wet weather. Humidity contain into the meteorological structure led to at least three raining days in this area. The conjunction of rain and fission products into the atmosphere led to a contamination of the Tokyo area.

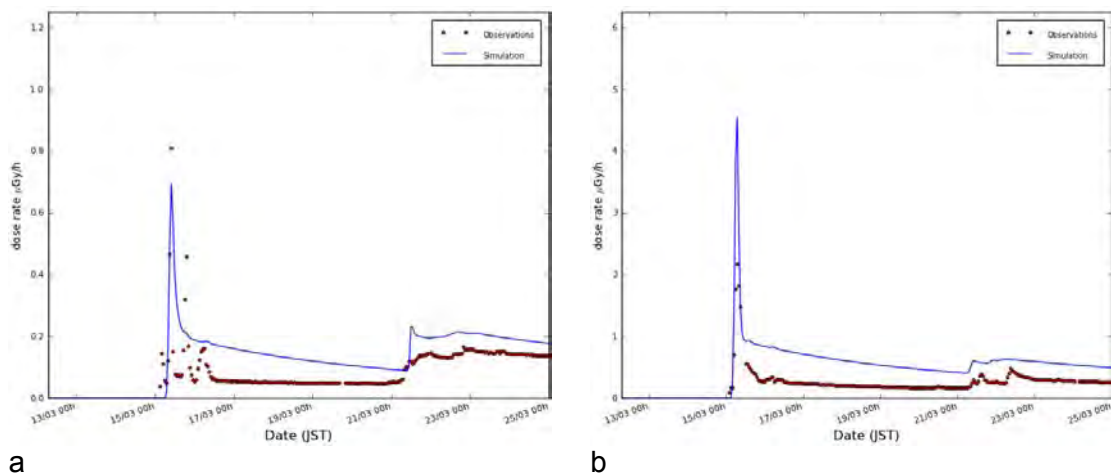

Figure 7 - Dose rate comparisons - Tokyo city centre (a) and in Hitachiōmiya (b)

Conclusion

The paper underlines the methodology adopted to assess the state of the different units of Fukushima Dai-Ichi site during the emergency situation faced by Japan in March 2011. It summarizes the main conclusions of the evaluation of the source term, too. The behaviour of the atmospheric releases is also analysed and compared to some available measurements (mainly dose rate ones).

Preliminary results show a fairly good agreement with observations in Japan. Nevertheless, complementary and more comprehensive studies are still necessary to investigate in depth the events which occurred on the site to evaluate their consequences in terms of atmospheric releases which are likely to affect the environment and the public.

References

- [1] Isnard O., Raimond E., Corbin D. and Denis J., Radioactive source term and release in the environment, Proceedings of the Eurosafe Forum 2011, Conference, Paris, November 2011.
- [2] Chino M., Nakayama H., Nagai H., Terada H., Katata G., Yamazawa H. Preliminary Estimation of Release Amounts of I-131 and Cs-137 accidentally Discharged from the Fukushima Daiichi Nuclear Power Plant into the Atmosphere. 2011. J. of Nuc. Science and Technology. Vol 48, N°7, pp 1129-1134.
- [3] Bannai, T. Regarding the Evaluation of the Conditions on Reactor Cores of Unit 1, 2 and 3 related to the Accident at Fukushima Dai-ichi Nuclear Power Station, Tokyo Electric Power Co. Inc. Nuclear and Industrial Safety Agency, June 6, 2011.
- [4] <http://www.jma.go.jp/en/amedas>
- [5] Krysta, M., Bocquet, M., Sportisse, B., Isnard, O. Data assimilation for short-range dispersion of radionuclides: An application to wind tunnel data. 2006. Atmos. Env. Vol 40, N° 38, pp 7267-7279.
- [6] Chang, J., Hanna, S. Air quality model performance evaluation. 2004. J. Appl. Meteor. Vol 47, pp 888-900.
- [7] Quélo, D., Krysta, M., Bocquet, M., Isnard, O., Minier, Y., Sportisse, B. Validation of the Polyphemus platform on the ETEX, Chernobyl and Algeciras cases. 2007. Atmos. Env., vol 41, N° 26, pp 5300-5315.
- [8] Mallet, V. Technical Note: The air quality modelling system Polyphemus. 2007. Atmos. Chem. Phys. Vol 7, pp 5479-5487.
- [9] <http://www.slideshare.net/energy/ams-data-april-4v1>

Technical Session 2 – The roadmap: status and perspectives towards the restoration

INTRODUCTION TO THE RESTORATION ROADMAPS

“Status of Fukushima NPS and Roadmaps Towards Restoration & Decommissioning”

Kunihisa SODA

JAEA, Fellow, soda.kunihisa@jaea.go.jp

Abstract

The Fukushima Nuclear Power Stations of TEPCO were seriously damaged after total loss of off-site and on-site powers because of damages caused by the earthquake and tsunami which were far above the postulated level. Investigation by the Government has pointed out in its preliminary report the importance of consideration of event of low probability but of high risk consequence in the safety assessment of NPP. Regulators have requested utilities to reassess their plants and if needed, improve and enhance safety of NPPs. The first phase of the restoration of the Plants has made progress and achieved stable conditions of the Plant. The roadmap towards decommissioning has been proposed to and approved by the Government and difficult and complicated task has just started for lasting next 30 to 40 years. Information dissemination and cooperation among the international community should be pursued to utilize experience to ensure safe operation of NPP around the world.

Keywords

Fukushima, Earthquake, Tsunami, Core melt, Decommissioning

Introduction

Fukushima Daiichi Nuclear Power Stations were attacked by the Tohoku Pacific Ocean Earthquake of magnitude 9.0 and the gigantic tsunami which caused loss of off-site power and on-site power for emergency at the same time. As the result, core melt and hydrogen explosion occurred and the Plants were seriously damaged to the extent that recovery of the plant would not be feasible. Decision was made to decommission the Plants and the Roadmap towards Decommissioning has been proposed by TEPCO for the period beyond the completion of Step 1 and Step 2 of the previous roadmap towards restoration to achieve stable conditions at the Plant. The Government confirmed completion of Step 2 and approved the roadmap towards decommissioning.

The roadmap towards decommissioning consists of; Fuel removal from spent fuel pool (Phase 1), Fuel debris removal (Phase 2), and Complete removal of fuel debris, decommissioning, and radioactive waste processing and disposal (Phase 3). The whole process may take 30 to 40 years after the completion of Step 2. It is anticipated that research and development are needed for preparation of tools, instrumentations and processes for decommissioning to understand the plant condition in detail.

The government of Japan has determined to initiate an international framework of cooperation towards decommissioning of the Fukushima Daiichi NPS to share all information which will be gained from decommissioning process and to make contribution to enhance safety of nuclear power plants in the world.

1. Tohoku Pacific Ocean Earthquake and the Accident at Fukushima NPS

Tohoku (East-North) region of Honshu Island of Japan was shaken by the earthquake of magnitude 9.0 and the gigantic tsunami along the east coast from Aomori to Chiba prefectures. **(Slide 3)** The earthquake was caused by the plate's movement near Honshu Island of Japan and resulted in five major earthquakes of magnitude higher than 7.0 within 3 days and many more of small ones. **(Slide 4)**

Fukushima Daiichi Nuclear Power Station was struck by the most powerful earthquake among those earthquakes. Location of the Fukushima NPS is about 180 km from the epicentre of the earthquake and was flooded by the tsunami which caused total station blackout at the site and all NPSs were entirely damaged by core melt and hydrogen explosion. Emergency was declared by the Government and all effort were made to bring the plant to stable conditions by TEPCO and the Plant state became stable by the end of 2011.

The earthquake was extremely powerful earthquake than expected in that region. Tsunami attacked the east coast of Honshu Island and left destruction and loss of 20,000 peoples' lives to the local area along the coast. At the Fukushima NPS, there were no preparation and/or preventive measures against tsunami considerably exceeding the tsunami height which was postulated for selection of the site and safety analysis of the design of the plant.

The present safety guides for licensing purpose require that the earthquake is considered to include detailed analysis of the regions within 30 km range and historical data. Tsunami is also taken into account based upon the past historical record accepted by the academic society. As seismic study has made progress in the past 10 years, most updated information is taken into account for the safety analysis. However it depends on the accuracy of information and safety consciousness to operate their plant safely even for the extraordinary case.

It should be recognized that there are other NPS along the east coast of Tohoku district for which preparation against tsunami has been reinforced and all of them survived from the tsunami by the precautious measures adopted. **(Slides 5-7)**

It is recognized that structural strength against the earthquake had enough margin to maintain its integrity as seen from the maximum response acceleration compared with those of the licensing basis based on the seismic back-check requirement which is much higher value than the initial licensing basis. **(Slide 8)**

List of PPT No.

- S3: Tohoku Pacific Ocean Earthquake and the Accident at Fukushima NPS
- S4: Tohoku Pacific Ocean Earthquake, Earthquakes and Coseismic Slip
- S5: Tsunami: At Fukushima Daiichi and Daini NPS
- S6: Tsunami: At Onagawa NPS and Tokai Daini NPS
- S7: Damage Caused by Tsunami: Comparison of NPS
- S8: Maximum Response Acceleration: Comparison with the licensing basis

2. Status of Fukushima NPS

Plant status has been brought to stable condition, which is equivalent to cold shut downstate, by effort of workers at the plant who struggled with damaged plants after tsunami, station blackout, core melt, hydrogen explosion, loss of cooling capability and others. Plant parameters measured by available instrumentations now indicate that the conditions of all NPS at the Fukushima Daiichi NPS are stable and cooling of the damaged core and structures are maintained. **(Slide 10)**

Monitoring data at the site boundary now indicates decreasing trend and no indication of increase even though the level of radiation is much higher than normal value. **(Slide 11)**

Monitoring data in the surroundings of Fukushima NPS also show trend of decrease, but may take longer time to reach normal level. **(Slide 12)** Present condition indicates that decontamination is necessary for return of residents in those regions. It is anticipated that those who have been evacuated from the zones close to the site may need longer time to stay outside of those regions until decontamination is completed. **(Slide 13)**

List of PPT No.

- S10 Plant Status - Plant parameters at Fukushima NPS
- S11 Monitoring Data - At the Site Boundary of Fukushima Daiichi NPS
- S12 Monitoring Data - In the surroundings of Fukushima Daiichi NPS
- S13 Sheltering and Evacuation - Emergency declaration by the Government

3. Roadmap Towards Restoration from the Accident

After having achieved stable condition equivalent to cold shut-down and significant reduction of radioactive materials release to the environment, the Government team confirmed completion of Step 1 and Step 2 on the basis that the plant conditions have met the goals of Step 1 and Step 2 of the Roadmap Towards Restoration from the Accident; 1) Stable circulation of cooling water has been established and secured, and 2) Radiation dose at the site boundaries has reached at sufficiently low level. It is noted that major issues of concern during the restoration process of Step 1 and Step 2 were I) Cooling, II) Mitigation, III) Monitoring and decontamination, IV) Counter measures against aftershock etc., and V) Environment restoration. **(Slides 15-16)**

List of PPT No.

- S15 Roadmap Towards Restoration: Completion of Step 1 and Step 2 (1/2)
- S16 Roadmap Towards Restoration: Completion of Step 1 and Step 2 (2/2)

4. Mid-and-Long Term Roadmap Towards Decommissioning [3]

Mid-and-Long Term Roadmap **(Slide 18)** has started soon after the Roadmap towards Restoration from the Accident achieved its goals and completion of Step 2 was declared by the Government team. The goal of the Mid-and-Long Term Roadmap is to decommission the plants and the total duration of the Roadmap may go around 40 years depending on its progress. It is anticipated that there will be uncertainties and/or difficulties to achieve the goal because details of status of damages at the Fukushima NPS have not been identified in detail yet and there items and areas for which research and development of technology are needed towards decommissioning.

Mid-and-Long term roadmap consists of three phases in order to take step by step approach until completion of decommissioning. They are:

Phase 1 (*within 2 years**) * denotes years after completion of Step 2

- Fuel removal from the spent fuel pool (Unit 4)
- R&D for RW processing and disposal

Phase 2 (*within 10 years**):

- Fuel debris removal,
- R&D for RW reprocessing and debris removal

Phase 3 (*after 30 to 40 years**):

- Complete removal of fuel debris (20 to 25 years*) and decommissioning (30 to 40 years*),
- Implement RW processing and disposal

In order to complete the Mid-and-Long Term Roadmap with success, research and development of technologies are needed especially for removal of fuel debris, characterization of fuel debris and radioactive wastes, processing and disposal of radioactive waste arising from decommissioning, long-term-storage and other items which may arise in future. **(Slides 19-20)** Experience, knowledge and technology to be gained from the restoration process should be shared with the international community to ensure and enhance the level of safety of NPS.

List of PPT No.

S18 Mid-and-Long Term Roadmap - Towards the end of decommissioning

S19 Issues for Technology Development - Removal of Fuel Debris

S20 Issues for Technology Development - Radioactive waste processing and disposal

5. Lessons Learned from the Accident

Remarks

It is noted that safety regulation and requirements in Japan do not specifically request in the licensing process to assess margin of safety against events of low probability but high risk consequence. Based on lessons learned from the Fukushima Accident, regulators and stakeholders have initiated to reassess safety of all existing NPPs against such events to confirm robustness, and if found necessary, to improve and enhance safety.

5.1 Investigation of the Accident at Fukushima NPS by the Government [4]

The Investigation Committee of the Government on the Accident at Fukushima NPS of TEPCO released the interim report on the Fukushima Accident. In its executive summary, the preliminary conclusions are i) Lack of severe accident measures against tsunami, ii) Lack of view point of complex disaster, and iii) Lack of viewpoint of looking at the whole picture of accident. The preliminary conclusions are applicable not only the Fukushima Accident, but to other cases. It should be treated as warning to the nuclear community to achieve high level of safety for future operation of nuclear power plants. Its message is that if not pursued, nuclear power would not be supported by the committee. Investigation by the Committee continues.

5.2 Reassessment of Safety of NPS [5]

The regulatory organization requested all utilities operating NPS to reassess safety of nuclear power plants to confirm their robustness against extreme cases beyond the design basis. It is anticipated that if found necessary, the plant should be improved to enhance safety based on the reassessment. It is noted that extreme cases are not limited to earthquake and tsunami, but other cases may exist, for example different natural hazard etc. All possibilities must be taken care of to ensure safety of NPS anywhere in the world.

Assessment is also expected to review for all issues of safety whenever needed, i.e. Site selection, Safety design for prevention, mitigation and management to minimize consequences, Emergency planning to protect people and the environment, Operators training, Knowledge transfer, Safety Culture, Management, Financial stability, Communication with the public and the international community etc., Multiple external events, Multi-units site, Information dissemination to the public and the international community, Safety culture, Knowledge transfer and management, and others.

5.3 Restructure of regulatory organizations [6]

The Cabinet Office has initiated to restructure the existing organizations for nuclear safety regulation, namely Nuclear Safety Commission (NSC), Nuclear and Industrial Safety Agency (NISA) and several offices of Ministry of Education, Culture, Sport, Science and Technology (MEXT) and to establish a single and independent regulatory organization for nuclear safety under the Ministry of Environment. The new regulatory organization is expected to be an independent from the Government Agency which is responsible for promoting use of nuclear energy. The restructure of regulatory organizations is a reflection to the comments and recommendation which were made at the CNS and by the IRRS mission to Japan in the past.

References

- [1] Nuclear Emergency Response Head Quarters, Government of Japan. Report of Japanese Government to the IAEA Ministerial Conference on Nuclear Safety:
 - 1.1 The Accident at TEPCO's Fukushima Nuclear Power Stations, June 2011 (http://www.kantei.go.jp/foreign/kan/topics/201106/iaea_houkokusho_e.html)
 - 1.2 Additional Report of the Japanese Government to the IAEA (Second Report), September 2011 (http://www.meti.go.jp/english/earthquake/nuclear/iaea/iaea_110911.html)
- [2] MEXT. Readings at Reading Points out of TEPCO Fukushima Dai-ichi NPP. January 27, 2012 (<http://radioactivity.mext.go.jp/en> then look for "Readings at monitoring post out of 20 km zone of Fukushima Daiichi NPP.")
- [3] TEPCO. The Great East Japan Earthquake and Current Status of Nuclear Power Station³. January 27, 2012. (http://www.tepco.co.jp/en/nu/fukushima-np/f1/images/f12np-gaiyou_e_1.pdf)
 - 3.1 Overview of the Earthquake & Tsunami and Nuclear Accident, January 27, 2012 (updated)
 - 3.2 Roadmap towards Restoration from the Accident (Step 2 completed), as of January 27, 2012
 - 3.3 Current Status of Fukushima Daiichi Nuclear Power Station, as of January 27, 2012
 - 3.4 Mid-and-long Term Roadmap, as of January 27, 2012
- [4] The Investigation Committee on the Accident at Fukushima NPS of TEPCO. Executive Summary of the Interim Report. December 26, 2011. (<http://www.icanps.go.jp/eng/interim-report.html>)
- [5] NISA. Regarding the Implementation of Comprehensive Assessments for the Safety of Existing Power Reactor Facilities Taking into Account the Accident at Fukushima Dai-ichi Nuclear Power Station, Tokyo Electric Power Co. Inc. August 30, 2011. (<http://www.nisa.meti.go.jp/english/press/2011/08/en20110831-2.html>)
- [6] Cabinet Secretariat, Government of Japan. Nuclear Safety Regulation Reform in Japan. The International Workshop on Nuclear Safety Regulation, Tokyo, Japan, January 18, 2012. (http://www.cas.go.jp/jp/genpatsujiko/info/kokusaiws/siryo/reform_of_regulation.pdf)

³ Report contains materials for which all rights are reserved by TEPCO.

RADIATION MONITORING AND ENVIRONMENTAL DECONTAMINATION PERSPECTIVES

Kimiaki SAITO

JAEA, Headquarters of Fukushima Partnership Operations, saito.kimiaki@jaea.go.jp

Abstract

Several different kinds of maps on contamination due to the Fukushima nuclear accident were constructed based on the results of extensive environmental monitoring conducted from June 6, 2011 to July 8. These maps covering over 100 km from the site present distributions of deposited radionuclide concentration per area for gamma-, alpha- and beta-emission radionuclides, and distributions of dose rates in air measured by survey meters above the ground and by car-borne survey systems. Model projects aiming at demonstration of decontamination technologies and methods have been conducted, and knowledge has been accumulated through the projects. Based on the accumulated knowledge, full-scale decontamination has started subject to the decontamination roadmap having separate schedules according to radiation level.

Keywords

Radiation monitoring, contamination maps, car-borne survey, decontamination roadmap, model projects, full-scale decontamination

Introduction

In the Fukushima accident, a large amount of radionuclides were released into the atmosphere and wide regions were contaminated. In order to evaluate the impact of the accident and take appropriate countermeasures, it was necessary to obtain accurate and precise information on contamination conditions. Thus, a project was conducted to construct detailed contamination maps based on reliable and comprehensive environmental monitoring sponsored by the Ministry of Education, Sports, Science and Technology (MEXT). In this paper, some results from the project will be presented. Meanwhile, model projects for decontamination selecting several sites with different radiation levels and conditions have been performed and provided novel knowledge, being followed by full-scale decontamination subject to the roadmap formulated by the Ministry of the Environment. Outlines of the model projects and the roadmap will be presented.

1. Radiation monitoring and mapping

1.1 Soil sampling and radionuclides analyses

The region within 80 km from the Fukushima nuclear power plant site was divided into rectangular areas at 2x2 km² and the region between 80 to 100 km and the rest of the Fukushima prefecture were divided into areas at 10x10 km². One appropriate location was selected for each area, and five soil samples per location were collected using a plastic container up to 5 cm depth. More than 10,000 soil samples were collected and analysed using Ge detectors to quantify radioactivity of several dominant radionuclides. At each location, the dose rate in air was measured by a calibrated survey meter. Concerning gamma-ray emission nuclides, maps showing nuclide concentration per area were constructed for ¹³⁷Cs, ¹³⁴Cs, ¹³¹I,

^{129m}Te , ^{110m}Ag . Further, maps for ^{238}Pu , $^{239+240}\text{Pu}$, ^{89}Sr and ^{90}Sr were constructed by analysing 100 selected samples.

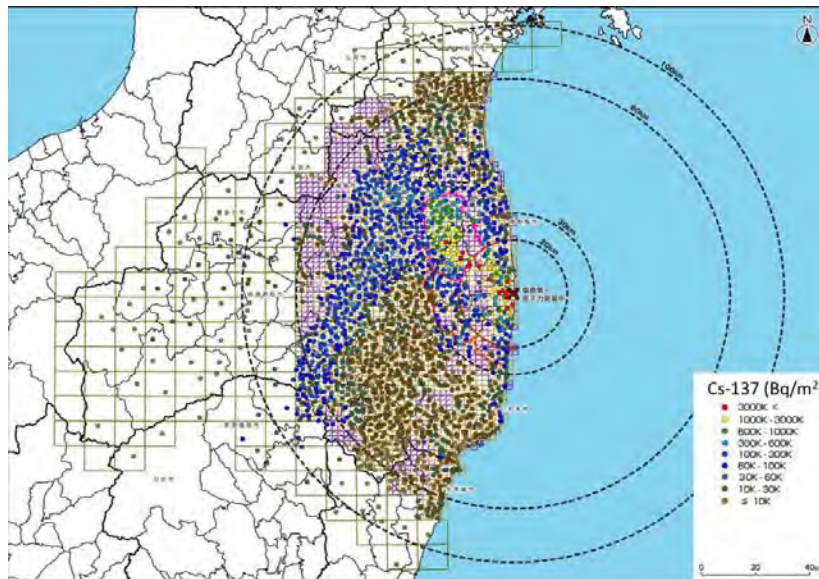

Figure 1 – ^{137}Cs deposition map normalized to June 14, 2011

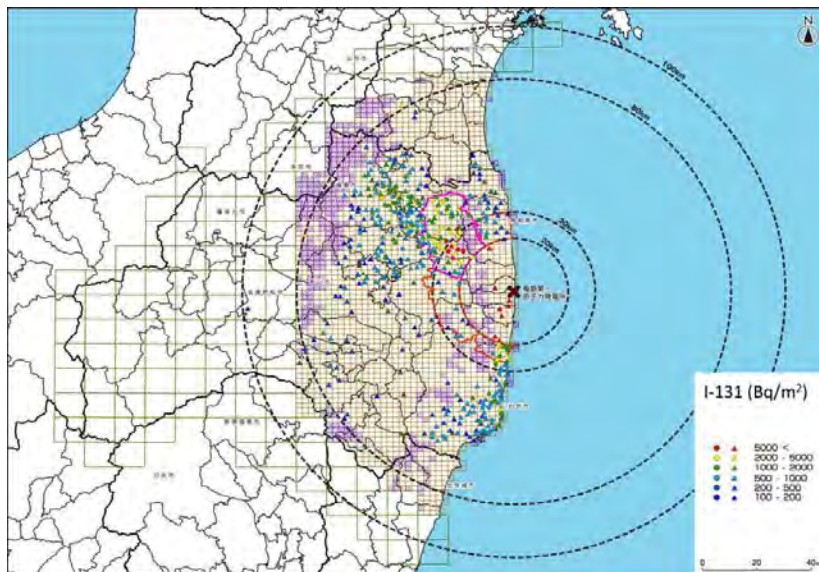

Figure 2 – ^{131}I deposition map normalized to June 14, 2011

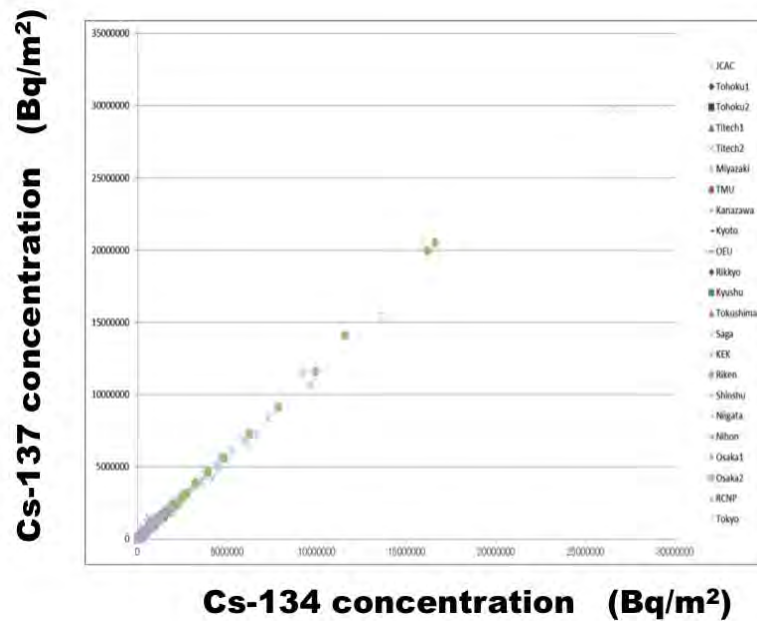

Figure 3 – Correlation of concentrations between ^{137}Cs and ^{134}Cs

1.2 Car-borne survey

Car-borne surveys were performed using six taxis equipped with the KURAMA systems which successively send dose rate and position data through a cellular network. The survey data were saved on the main server on time and shown on the screen with a Google Earth picture. Roads at more than 17,000 km were covered by the surveys. After noises were removed, dose rates were superimposed on map data by the Geological Survey Institute which provides the standard map data of Japan.

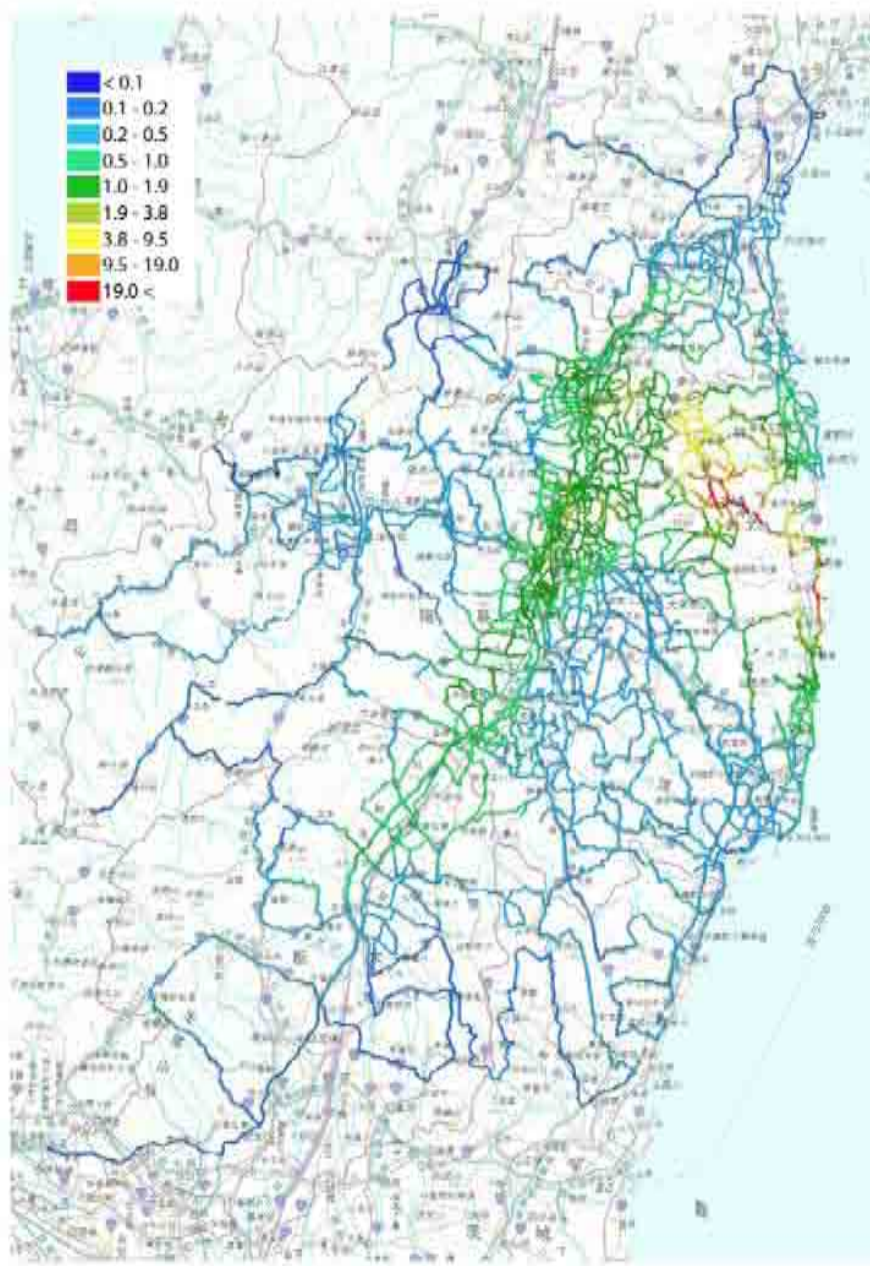

Figure 3 – Dose rate distribution in air (mSv/h) obtained from car-borne survey carried out in June, 2011

2. Decontamination perspectives

2.1 Decontamination roadmap

Act on the Special Measures describing basic concepts for decontamination was fully enforced in Jan 1, 2012. The Ministry of the Environment (MOE) formulated roadmaps for decontamination. Full-scale decontamination is scheduled separately according to different radiation levels. Areas at less than 20 mSv/y are classified as zones to lift the evacuation directive. Here, decontamination activities, set-up of infrastructures and employment will be conducted in urgent. And evacuation instruction will be ended as soon as basic living

conditions are established. Areas at 20-50 mSv/y are classified as zones where residency is restricted. In the areas, it is anticipated to take a few years to reduce the annual dose below 20 mSv. Residents can visit their houses for a short time. In case that the radiation level becomes low enough according to decontamination, people can return to their houses. Areas at more than 50 mSv/h are classified as zones that are difficult for residents to return. In these areas, it would be not anticipated that people become able to live there within 5 years. Decontamination model projects will be performed in the zones. In the zone below 20 mSv/y, radiation levels are further classified into three different levels, 10-20, 5-10 and 1-5 mSv/y, and in the order decontamination activities are conducted.

Decontamination Roadmap for New Evacuation Zones

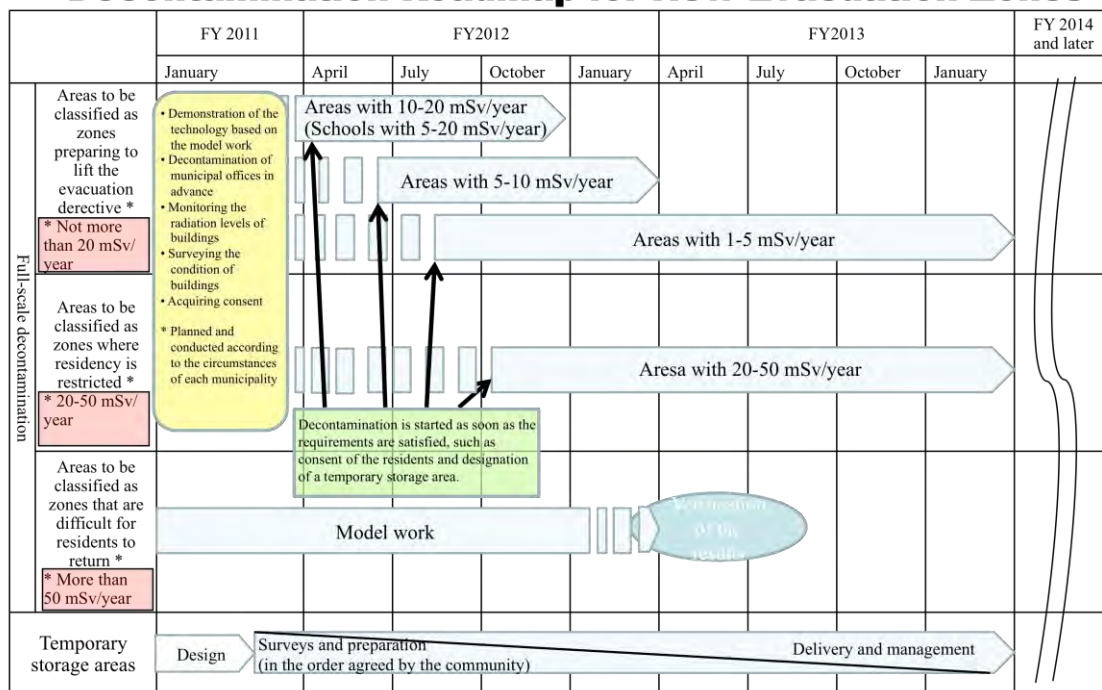

* Each municipal government specifies the concrete decontamination procedures.
 * Technical knowledge obtained through the model work (Cabinet Office and the Ministry of the Environment) is applied to decontamination at the appropriate time.

1.2 Decontamination model projects

The purpose of model projects was to evaluate efficiency, production of wastes, cost and safety concerning current, improved or innovative decontamination technologies. In any case, detailed radiation surveys were performed at the surface of the ground and at 1 m height. At ground surface micro spots where dose rates are locally high were found, but in most cases they could not be found at 1 m height. JAEA developed a computer program to estimate dose rate reduction due to decontamination. This tool has been used to select appropriate remedial areas. A lot of new information was accumulated in the model projects.

Many decontamination methods have been tried: for examples, roofs and walls are washed with high-pressure water being collected to remove radioactivity and reused or discharged; concrete and asphalt are brushed or blasted by a few mm; top soil can be removed by spraying fixation agent and peeling off, or using a power shovel; plants and trees are clipped, and fallen leaves and leaf mold on the ground are removed resulting in reduction of radiation levels. Effectiveness of these decontamination techniques was evaluated, and the results are going to be reflected in the full-scale decontamination operations which are just starting.

Storage of radioactive wastes will be performed in three steps: 1) temporary storage, 2) intermediate storage, and 3) final storage. The intermediate storage facilities are planned to be constructed at three locations in the Fukushima prefectures. And final storage facilities are planned out of the Fukushima prefectures; however, concrete plans are not yet decided.

Conclusions

Radionuclide deposition maps and dose rate maps were constructed based on extensive environmental monitoring using standardized accurate methods. The obtained data are expected to be utilized for evaluation of environmental consequences and human health effects, and for judgment of countermeasures. The authors would like to thank all persons who helped the project directly and indirectly. The future of Fukushima depends on how radiation level decreases from now on.

References

- [1] Ministry of Education, Culture, Sports, Science and Technology. Monitoring information of environmental radioactivity level, 2011.
<http://radioactivity.mext.go.jp/ja/list/338/list-1.html>
- [2] K. Saito. Detailed investigation on contamination around the Fukushima site. Japanese J. Health Physics, vol. 46, no. 3, pp. 210–214, 2011.
- [3] Ministry of Environment. Decontamination roadmap, 2012.
<http://www.env.go.jp/jishin/rmp/attach/josen-area-roadmap.pdf>
- [4] Cabinet Office, Government Japan. Results of decontamination model projects, 2012.
<http://www.jaea.go.jp/fukushima/decon04/decon04-ke.html>

Technical Session 3 – The future: lessons learned and evolution perspectives

EMERGENCY PREPAREDNESS AND ON-SITE AND OFF-SITE RESPONSE SYSTEMS

Olivier ISNARD & Giovanni B. BRUNA
IRSN

Abstract

The IRSN's Technical Crisis Centre (*CTC*) is a national mean aiming at following, in real-time, radiological emergency situations in order to provide the French public Authorities with technical assessment and the general public with reliable information, and, if necessary contributing to the elaboration of an intervention scenario for the plant workers as well.

During the Fukushima crisis the *CTC* was setup in 24/7 operation mode and provided - on a daily basis - analysis and prognosis on the reactors and the radiological consequences of the ongoing events.

The Japanese emergency provided the *CTC* with a unique opportunity to check its preparedness to face radiological crisis situations.

1. Risk and Emergency Conditions

The fundamental principle in nuclear safety is the prime responsibility of the plant Operator (EDF, currently, in France), as it is the only actor in the field which is able to undertake the actions which can recover the plant(s) in case of miss-operation and/or incident and/or mitigate the consequences of the accidents.

To achieve these actions, in case of an emergency, the Operator is to rely on its own emergency organisation, which:

- Operates with the control of the Nuclear Safety Authority - a public authority - which verifies that the Operator fully endorses his responsibility in compliance with the regulatory requirements and duties,
- Communicates and exchanges with its own and external safety organisations,
- Relies on the Constructor's advice for undertaking the recovery actions,
- Provides the local and national Authorities and the general public with up-dated information on the plant status.

The Nuclear Safety Authority generally relies on Technical Safety Organisation(s) - TSOs - (in, France, the IRSN - Institut de Radioprotection et Sûreté Nucléaire -) for assessment, expertise, advice and technical support.

The goal of the IRSN's assessment of Nuclear Power Plants - NPPs - in emergency conditions is the diagnosis, then the prognosis, of the plant status, the preliminary rough quantification and the continuous improvement and up-dating of the potential risk for atmospheric releases of nuclear material, the information of the French Authorities and the general public, the contribution to the elaboration and settling of an intervention scenario for the plant workers and the advices (if necessary) to protect the population.

To achieve these ambitious objectives it is worth for IRSN:

- Mastering the NPP component and system design and operation and their weaknesses and main failure modes,
- Investigating the immediate origin of the event generating such risk (the initiating event, such as a system failure resulting from either an internal initiator or hazard, or a human miss-operation),

- Understanding the physical phenomena generating such risk and identifying its potential for evolution (likelihood and timing for core melting, explosion, containment bypass ...) and likelihood for propagation to other installation on site,
- Evaluating the amount of radionuclides likely to be released to the atmosphere (evaluation of the source term),
- Elaborating a dispersion scenario relying on the predicted and on-line up-dated information on the site features and the meteorological conditions (direction of dominant wind, rain ...),
- Monitoring the radioactivity spreading-off through a suitable monitoring network (Operator's network, TELERAY, aerosols monitoring stations),
- Dispatching emergency mobile means for helping local Authorities to achieve a monitoring plan,
- Providing the French Authorities with expertise,
- Communicating to the press and the public.

The IRSN's CTC has to achieve his missions, relying upon:

- A wide network of information and expertise gathering all the characters in the field (Operators, Constructors, Authorities, Technical-expert Organizations, advisers),
- The knowledge from periodical crisis exercises,
- The capitalization of knowledge through operating experience,
- The first-hand evaluations made with the available computation and prediction tools,
- The in-situ monitoring network and mobile devices,
- The outcomes of studies and R&D programs, carried-out within national and international frameworks,
- The back-up support from off-site expert teams to complete and refine rough evaluations,
- The application of the rules,
- The awareness of the socio-economical context (public acceptance, media coverage ...).

2. The Emergency Preparedness at IRSN

As a TSO, and member of the European ETSO - European Technical Safety Organisation Network -, the main objectives of IRSN are:

- Providing technical expertise to the French Nuclear Safety Authority,
- Communicating to the public and private stakeholders and to the general public,
- Performing R&D activities, either on its own or as an active member of international groups and initiatives, as well.

To achieve these withstanding goals, the IRSN relies on several hundred skilled experts in different fields of endeavour, ranging from the nuclear safety to the radioprotection of the environment and the health.

Among its main missions, as said above here, the IRSN accounts for the nuclear emergency and crisis situation preparation, management and recovery trough a dedicated Emergency Management Team, operating within a *CTC*, which is in charge of emergency preparedness and operational maintenance.

Emergency preparedness at IRSN represents more than 2000 training hours/year associated 12 to 15 national exercises/year, as well.

The logistics of the *CTC* relies upon 5 full-time persons, and about 25 full-time persons are working on organisational aspects (with Operators and Authorities), training and development of methods & tools.

As far as its intervention and monitoring capacity, IRSN can mobilise:

- 1 command car (liaison with *CTC*, preparation of sampling for measurement)
- 4 T5 car (light truck for intervention)
- 3 lab trucks for environment (1200 meas./d)
- 4 lab trucks for humans (960 p/d)
- 3 heavy trucks for humans (80 p/d)
- 4 shelters for humans (2100 p/d)
- 1 T5 car for transportation crisis

In case of a nuclear and/or radiological emergency, the *CTC* will be activated by the on call team (12 persons dedicated to the *CTC*, 12 other persons dedicated to the mobile means) within one-hour since any identified alert (emanating from the Operator, a member of an emergency service, the Nuclear Safety Authority...) and will be gradually completed up to its nominal size (up to 25 team-mates, depending on the severity of the events).

After the activation of the *CTC*, the emergency responders are trained to deliver a first advice in less than 1 hour.

The IRSN's *CTC* supports the French Authorities in the definition of actions to be implemented to protect the potentially affected population and the environment. Relying upon the information gradually made available and continuously up-dated on the affected nuclear installation(s), it evaluates the installation(s) state and prognoses its/their potential evolution for the near future.

Moreover, it evaluates the real and potential atmospheric releases of radiological material and the plume behaviour, and it assess the radiological consequences of these releases, as well. Météo-France - the state-owned organization for meteorological forecast - supports these evaluations providing the *CTC* with operational meteorological products to be used for the atmospheric dispersion evaluations.

3. Assessing the Fukushima Event

3.1 The CTC Alert and Activation

The IRSN's *CTC* was activated by an intern decision in the afternoon of Friday March 11, immediately after the divulgation of the information on the Fukushima Daiichi nuclear events.

The activation of the *CTC* lasted for 6 full weeks to provide continuous technical assistance to the French Government, communicate and inform the stakeholders and the public, as well.

This long lasting activation forced a modification of IRSN's internal organisation to allow it providing the conventional expertise activity on the French park, while managing the emergency, through the addition of an Health-unit dealing with any health issues and an Environment-unit, mainly in charge of monitoring the French territory.

Moreover, a technical adviser was dispatched to the French Embassy in Tokyo to give technical advises directly to the local Authority in charge of the French people living in Japan, and to attend public meetings to supply the French people and companies with explanations and advice on the situation and the incumbent risk.

3.2 The Reactor Assessment

To assess air contamination levels resulting from the accident affecting the Fukushima Dai-Ichi power plants, the IRSN's CTC made real time preliminary evaluations of the radioactivity likely to be released by the three damaged reactors over the March 12 to 22, 2011 period.

The assessment methodology [1] relied upon:

- The diagnosis of the state of the three reactors (understanding of the situation, state of cooling system, etc...);
- The expertise acquired by IRSN through its research programs on the behavior of fuel, under under-cooling conditions;
- The information provided by Japanese Authorities concerning intentional venting of the reactor containment buildings to protect the containments from the risk of degradation due to overpressure.

During this preliminary phase, only the radioactive elements with the most significant radiological consequences were considered, assuming proportions usually encountered in irradiated fuel and a core composed of 400 fuel assemblies for reactor 1 and 548 assemblies for both reactors 2 and 3. The evaluated amount of contaminants released during the reactor containment building venting (noble gases, iodine, caesium, tellurium, etc) was seen as a clear indicator of a significant degradation of fuel.

As an example, Figure 1 represents the release rate of iodine and caesium against time for the three reactors evaluated by the CTC as on March 22.

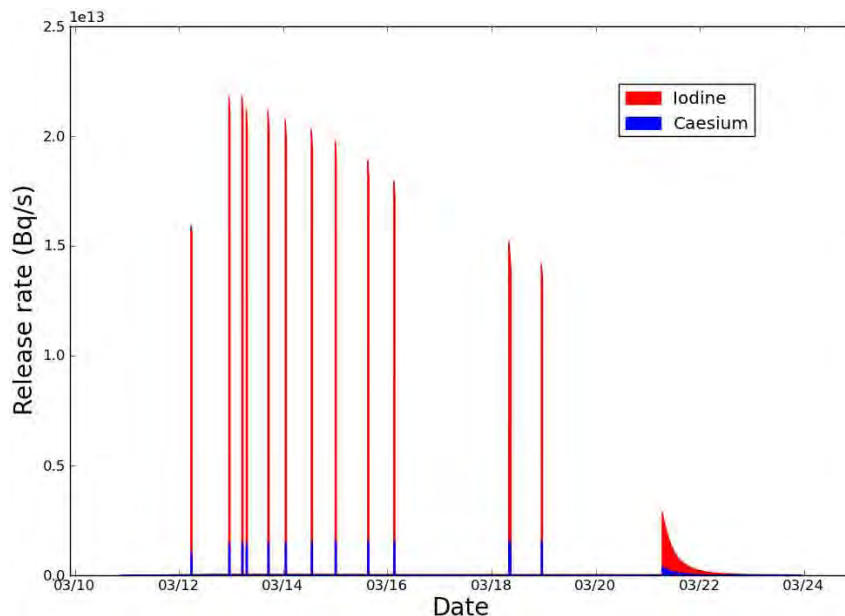

Figure 1 - Release rate of iodine and caesium for the three reactors

3.2 Evaluation of the Environmental Impact

IRSN's CTC simulated the atmospheric dispersion of the estimated releases emitted between 12 and 22 March using its long-range full 3D Eulerian operational numerical IdX [2], relying on the meteorological forecasts input provided by the Météo-France model ARPEGE and the source term evaluated independently [3].

The simulation has been continuously carried out since March 12.

As discussed in [3], the plume has got various directions during the investigation period: first, up to the northeast until March 14, then down to the south and southwest, towards Tokyo, on March 15, and then to the east and towards the Pacific Ocean.

The urban area of Tokyo witnessed two main episodes of contamination: the first one on March 15 and March 16, the second one on March 20 and March 23. The last one, characterized by a large rain episode, resulted in a larger contamination of the soil. Figure 2 illustrates the episodes of Tokyo area exposure.

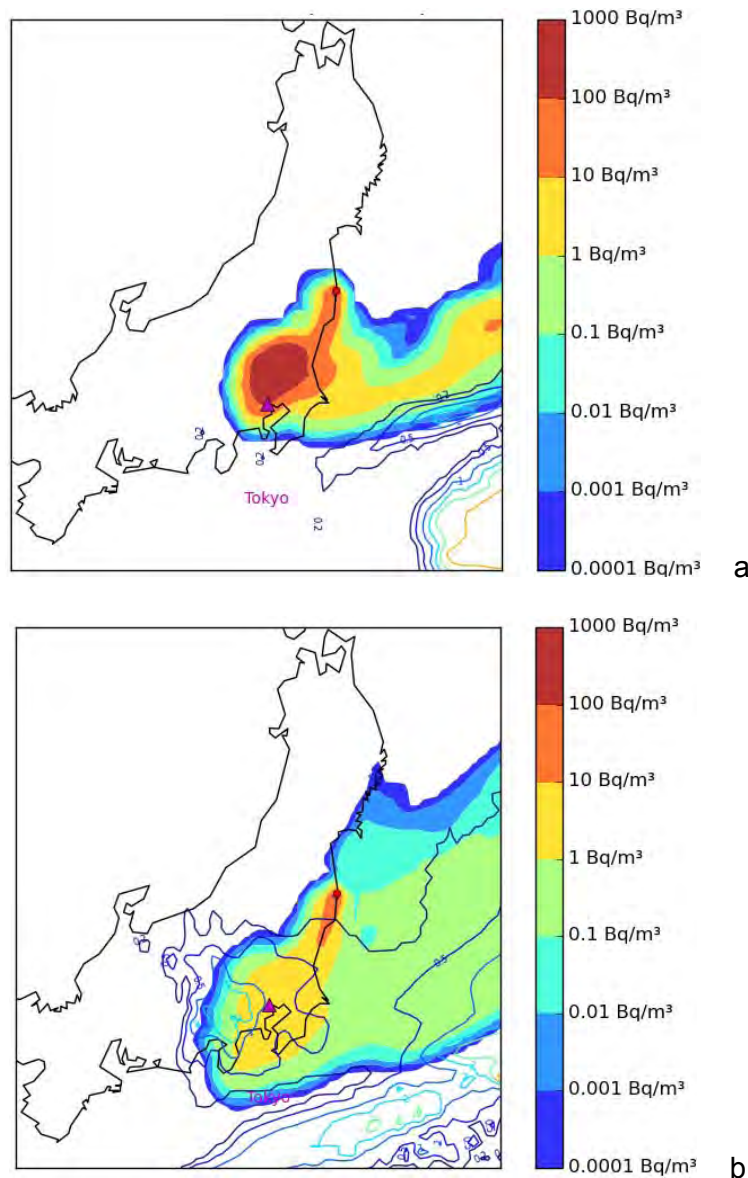

Figure 2 - Atmospheric air activity of I-131 and rain precipitation (mm/h)
- a March 15 at 06h JST - b March 21 at 15h JST

On March 15, as a consequence of the explosion occurred in Unit 2, several hour lasting releases appeared. Initially directed southward, they progressively moved west and north-westward as the wind direction changed. On March 15 evening, the plume, then directed north-westward, met a heavy rain episode. The wash-out of the radioactive plume created a large deposition onto the environment.

It is now widely acknowledged that, within a range of sixty kilometres around the Fukushima nuclear site, the major contamination of the environment originated from the Unit 2 releases. IRSN's CTC estimated the external dose people are likely to absorb in the most contaminated area surrounding the plant, within one year. Fig. 3 shows the external dose map published on April 8.

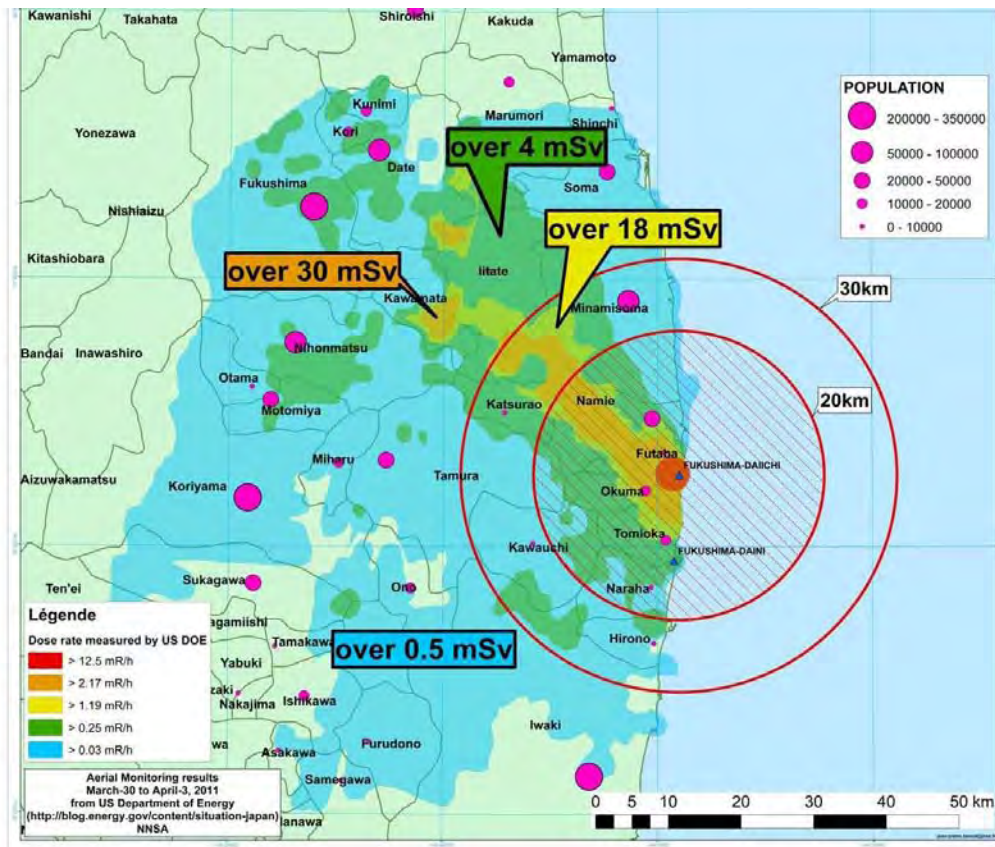

Figure 3 - First year external dose estimation for members of the public based upon US-DOE/NNSA measurements

This evaluation demonstrated the necessity for, at least, a temporary relocation of the population north-west of the nuclear site beyond the 20 km zone already evacuated.

Conclusion

The goal of the IRSN organisation in emergency situation is, as a TSO, the diagnosis and the prognosis of the potential risk for releases of nuclear material to the environment, the information of the French public Authorities and the stakeholders, but also the general public. This activity is currently carried-out by the IRSN's *Technical Crisis Centre (CTC)*. During the Fukushima nuclear emergency, the CTC was activated - in continuous operation - longer than 6 weeks and provided - on a daily basis - analysis and prognosis on the reactor status and the potential for radiological consequences of the on-going events. It contributed, that way, to the information of the stakeholders and the public. The Fukushima accident provided the IRSN's CTC with a unique opportunity to check its preparedness to face crisis situations in France and abroad.

References

- [1] Herviou, K. and Calmtrop, C., 2004: Methodology and tools for source term assessment in case of emergency. *Radiation Protection Dosimetry*, vol 109, pp 53-57.
- [2] Quélo, D., Krysta, M., Bocquet, M., Isnard, O., Minier, Y., Sportisse, B. Validation of the Polyphemus platform on the ETEX, Chernobyl and Algeciras cases. 2007. *Atmos. Env.*, vol 41, N° 26, pp 5300-5315.
- [3] O. Isnard, E. Raimond, D. Corbin and J. Denis & G.B. Bruna, Fukushima Dai-Ichi's Radioactive Source Term and Release in the Environment, presented at the Workshop "One year after Fukushima: rethinking the future", Italian National School for Public Administration, Bologna, March 2012.
- [4] <http://www.slideshare.net/energy/ams-data-april-4v1>

Acknowledgments

Authors are greatly indebted to all the members of the IRSN's *CTC* for their precious support and help.

Presentations

Reconstruction of the accident sequence and accident management

March, 2012

Takashi Sato

Tokyo Electric Power Company

What I will present

1. Overview of the Earthquake and Tsunami

- Damages at Fukushima NPSs
- What made the difference between Fukushima Daiichi(1F) and Fukushima daini(2F) ?

2. How we responded ?

- How the accident developed
- What difficulties existed

3. Other Relevant Items

- Accident Management
- Presumption of Reactor Core State by Analysis Code
- Hydrogen Explosion
- Spent Fuel Pool



1. Overview of the Earthquake and Tsunami



Overview of Fukushima Daiichi NPS (1F) and Fukushima Daini NPS (2F)

Plant	Unit	In Operation Since	Plant Type	Power Output (MWe)	Main Contractor	Pre-earthquake Status
1F	1	1971.3	BWR-3	460	GE	Operating
	2	1974.7	BWR-4	784	GE/Toshiba	Operating
	3	1976.3	BWR-4	784	Toshiba	Operating
	4	1978.10	BWR-4	784	Hitachi	Shutdown for maintenance Full core offloaded to spent fuel pool
	5	1978.4	BWR-4	784	Toshiba	Shutdown for maintenance
	6	1979.10	BWR-5	1100	GE/Toshiba	Shutdown for maintenance
2F	1	1982.4	BWR-5	1100	Toshiba	Operating
	2	1984.2	BWR-5	1100	Hitachi	Operating
	3	1985.6	BWR-5	1100	Toshiba	Operating
	4	1987.8	BWR-5	1100	Toshiba	Operating

The 2011 off the Pacific coast of Tohoku Earthquake

- **Time:** 2:46 pm on Fri, March 11, 2011.
- **Place:** Offshore Sanriku coast (approx. 180 km from Fukushima NPSs), 24km in depth, Magnitude 9.0
- **Intensity:** Level 6+ at Naraha, Tomioka, Okuma, and Futaba in Fukushima pref.

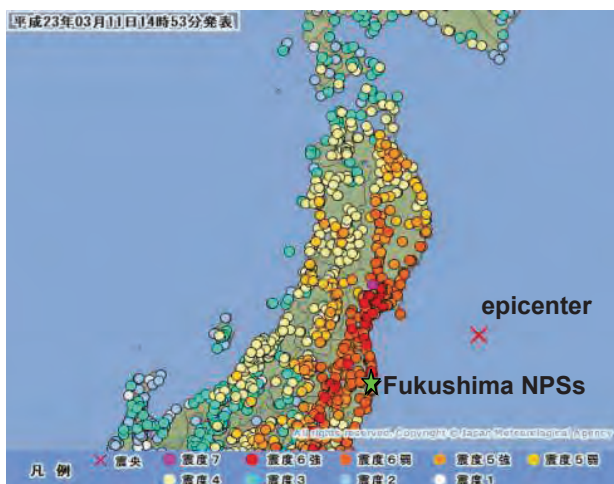

Safe shutdown: Unit 1-3 of 1F and Unit 1-4 of 2F were **successfully shut down** after the earthquake.

Scram set point by acceleration @ basement of reactor building: Horizontal=135-150 gal, Vertical=100gal

Damages by the earthquake: not fully inspected (Ex.inside PCV) but **safety related systems don't seem to be damaged.**

Seismic Observed Data

Comparison between Basic Earthquake Ground Motion and the record of intensity

Observation Point (The lowest basement of reactor buildings)		Observed data			Maximum Response Acceleration against Design Basis Earthquake (Gal)		
		Maximum Response Acceleration (Gal)					
		Horizontal (N-S)	Horizontal (E-W)	Vertical	Horizontal (N-S)	Horizontal (E-W)	Vertical
1F	Unit 1	460*	447*	258*	487	489	412
	Unit 2	348*	550*	302*	441	438	420
	Unit 3	322*	507*	231*	449	441	429
	Unit 4	281*	319*	200*	447	445	422
	Unit 5	311*	548*	256*	452	452	427
	Unit 6	298*	444*	244	445	448	415
2F	Unit 1	254	230*	305	434	434	512
	Unit 2	243	196*	232*	428	429	504
	Unit 3	277*	216*	208*	428	430	504
	Unit 4	210*	205*	288*	415	415	504

*: The recording time was about 130-150 seconds



Tsunami observed at 1F

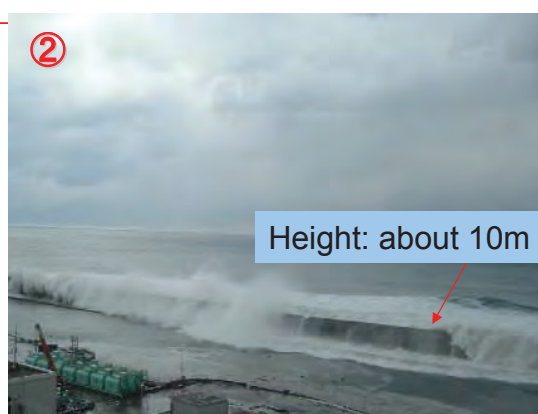
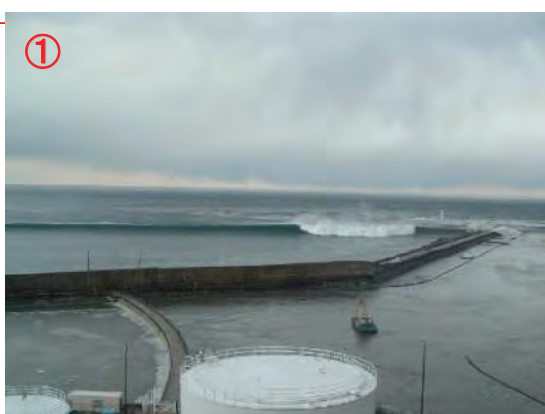

Flooding at 1F



Date : 2011/3/11 15:42



Date : 2011/3/11 15:42



Date : 2011/3/11 15:43



Date : 2011/3/11 15:43



Date : 2011/3/11 15:43



Date : 2011/3/11 15:44



All Rights Reserved ©2012The Tokyo Electric Power Company, Inc.

Damages by Tsunami at 1F



Heavy oil tank floated

Large size crane moved



All Rights Reserved ©2012The Tokyo Electric Power Company, Inc.

Damages by Tsunami at 1F

Sea water pumps were damaged.



Inundated Areas at 1F

- Inundation throughout almost all area where main buildings locate.
 - ✓ Units 1~4: Inundation height in the area where plant buildings locate: OP approx. 11.5m~15.5m (Localized inundation height in southwest area: OP approx. 16m~17m)
 - ✓ Unit 5 & 6: Inundation height in areas where principal buildings sited: OP approx. 13m~14.5m

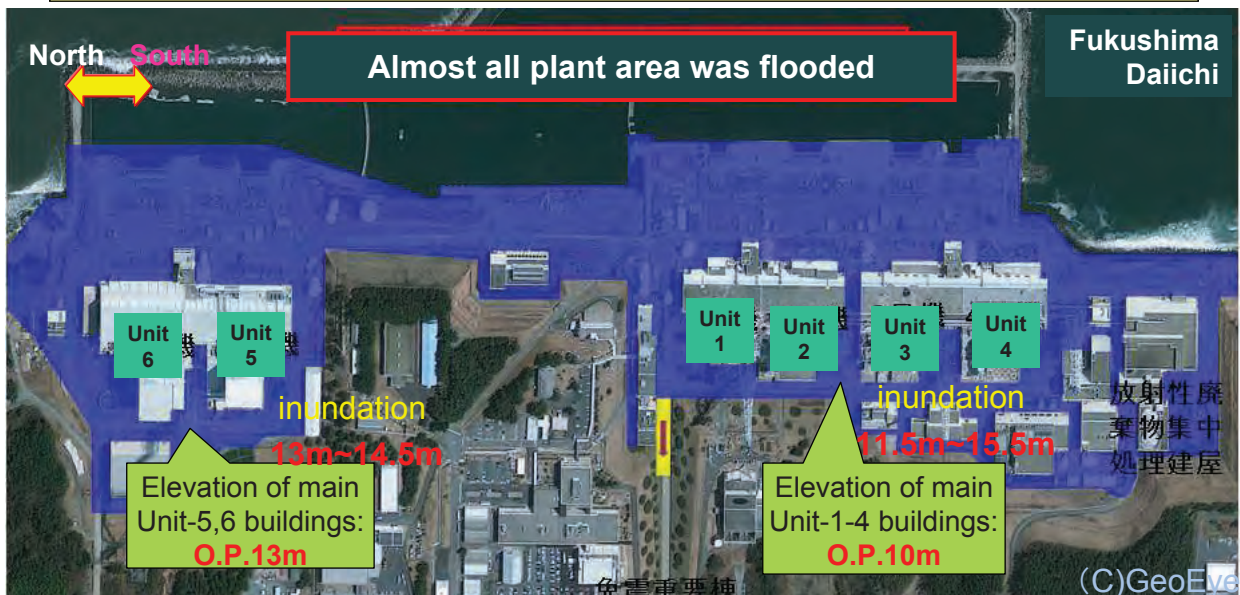

Location of Sea Water Ingression into Buildings at 1F

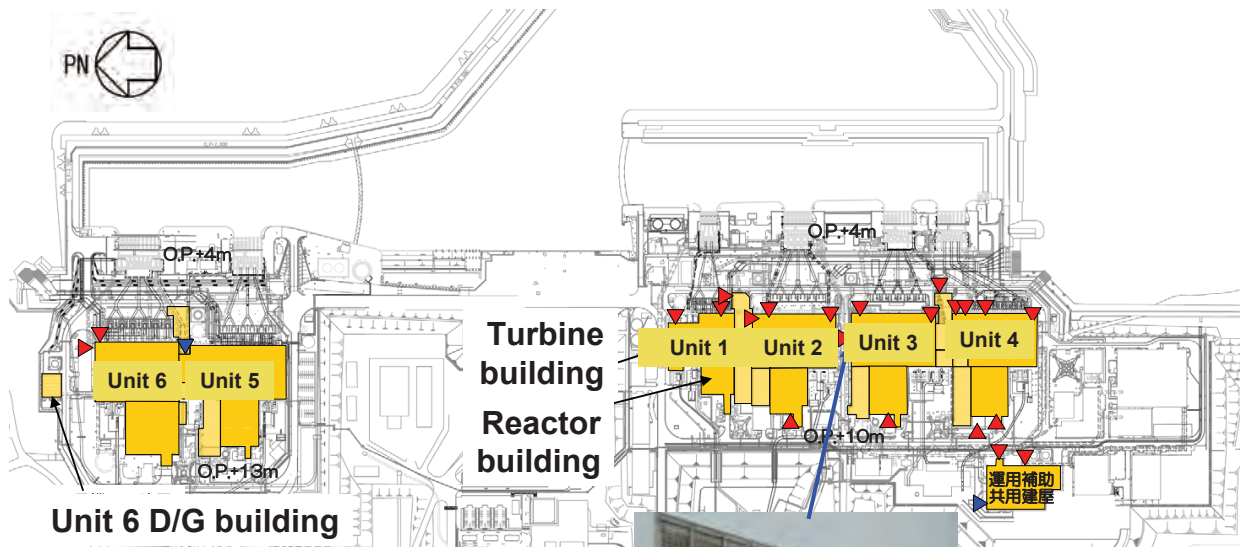

▼ : Openings at the ground level from which sea water could flow into buildings
 ▼ : Openings connected to underground trenches/ducts where sea water could flow into buildings

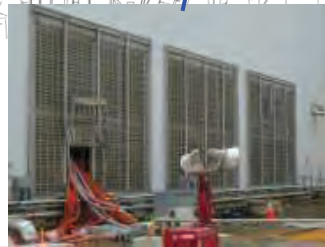

3u Emergency D/G air inlet louver

Inundated Areas at 2F

- Inundation occurred throughout all areas along the sea, but it was not observed to have inundated into areas where major buildings are sited.
- Run up of tsunami centered on the south side of Unit 1
 - ✓ Inundation height in sea side area: OP approx. +7.0~7.5m
 - ✓ Inundation height in areas where main buildings are sited: OP approx. 12~14.5m
 - ✓ Inundation height in area south of Unit 1: OP approx. + 15~16m

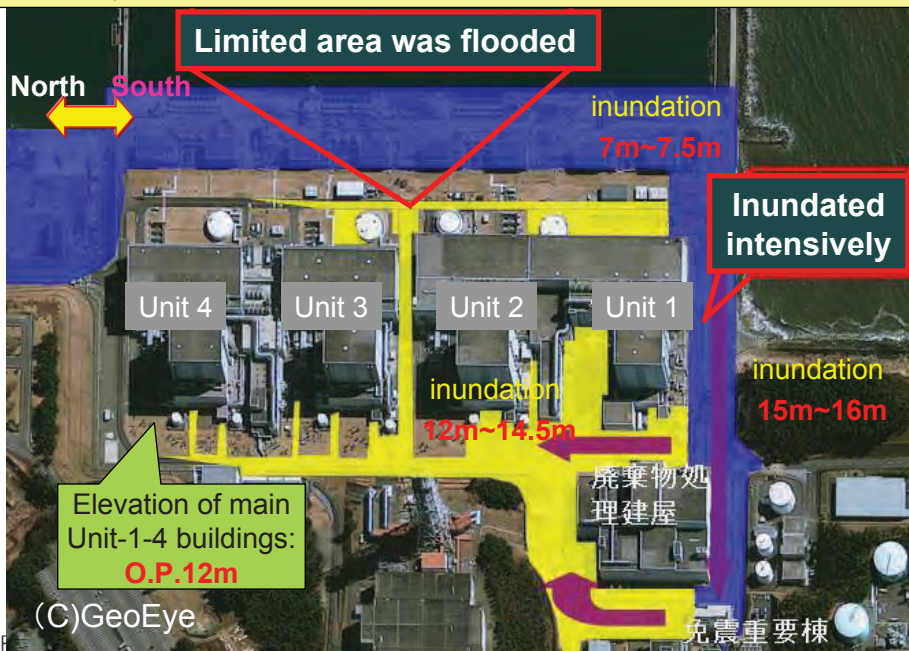

Tsunami damage at 2F



TOKYO ELECTRIC POWER COMPANY

All Rights Reserved ©2012The Tokyo Electric Power Company, Inc.

Location of Sea Water Ingression into Buildings at 2F

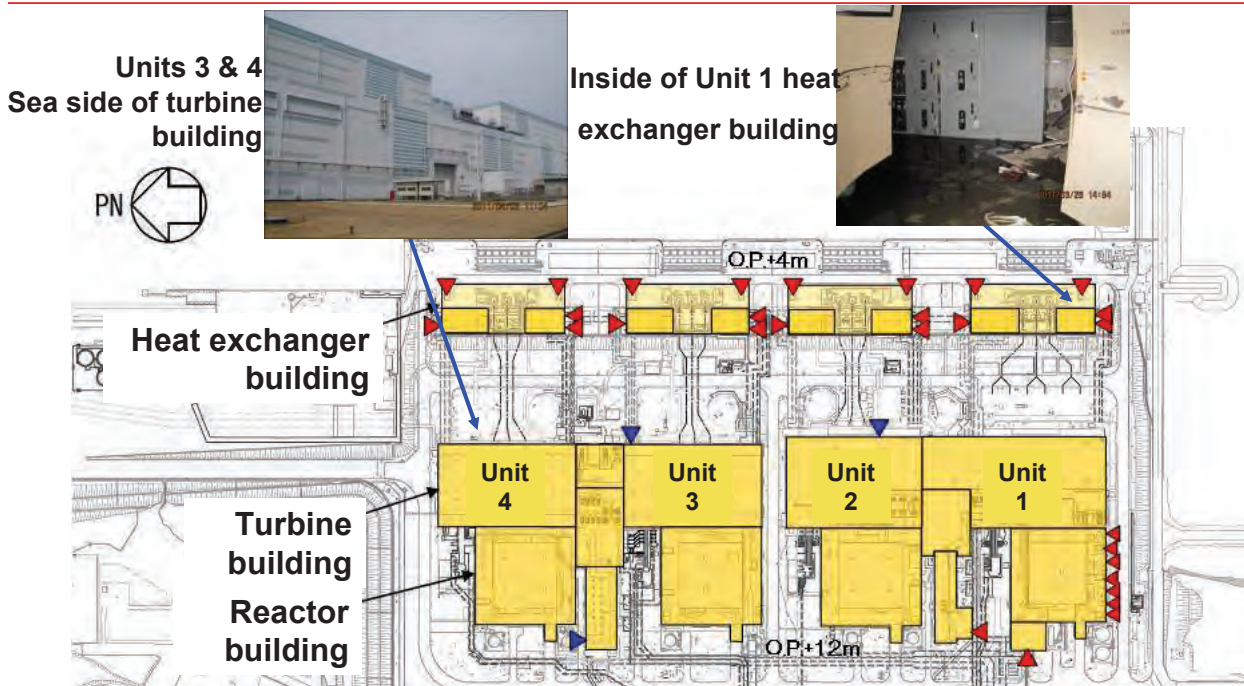

- ▼ : Openings at the ground level from which sea water could flow into buildings
- ▼ : Openings connected to underground trenches/ducts where sea water could flow into buildings



TOKYO ELECTRIC POWER COMPANY

All Rights Reserved ©2012The Tokyo Electric Power Company, Inc.

Tsunami Height 1F v.s. 2F

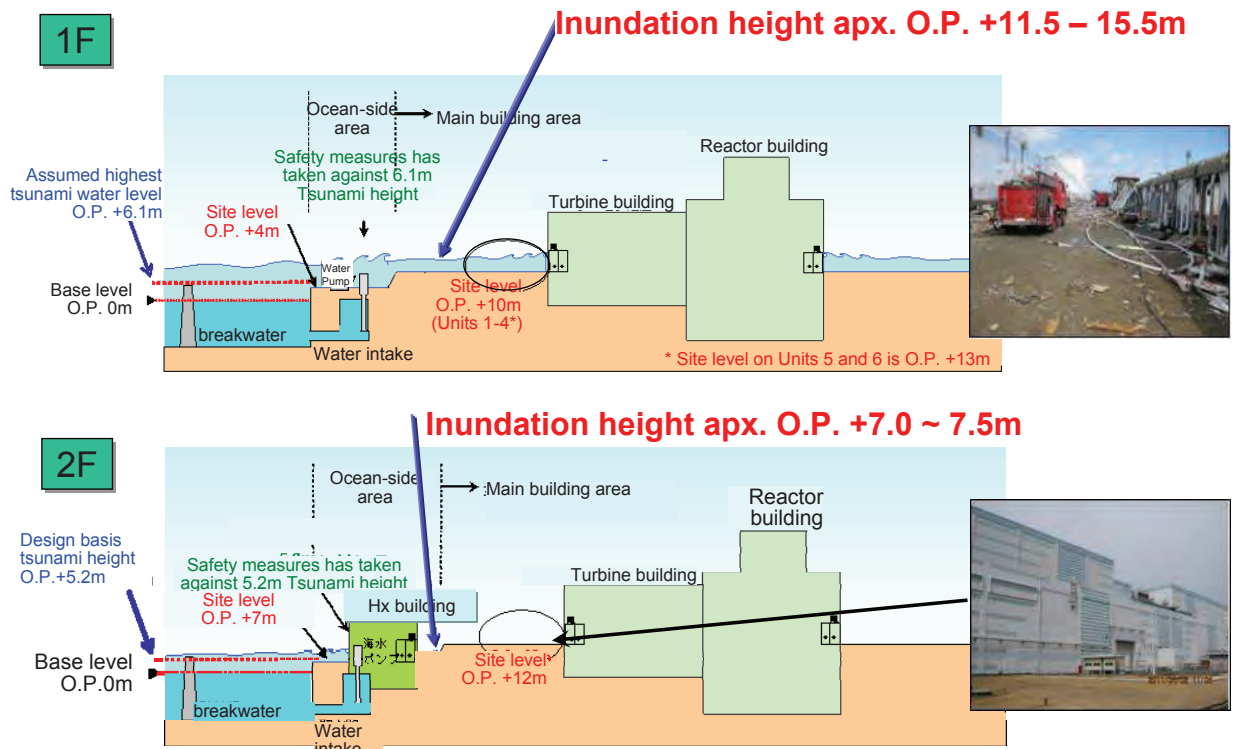

Differences in Tsunami between 1F and 2F

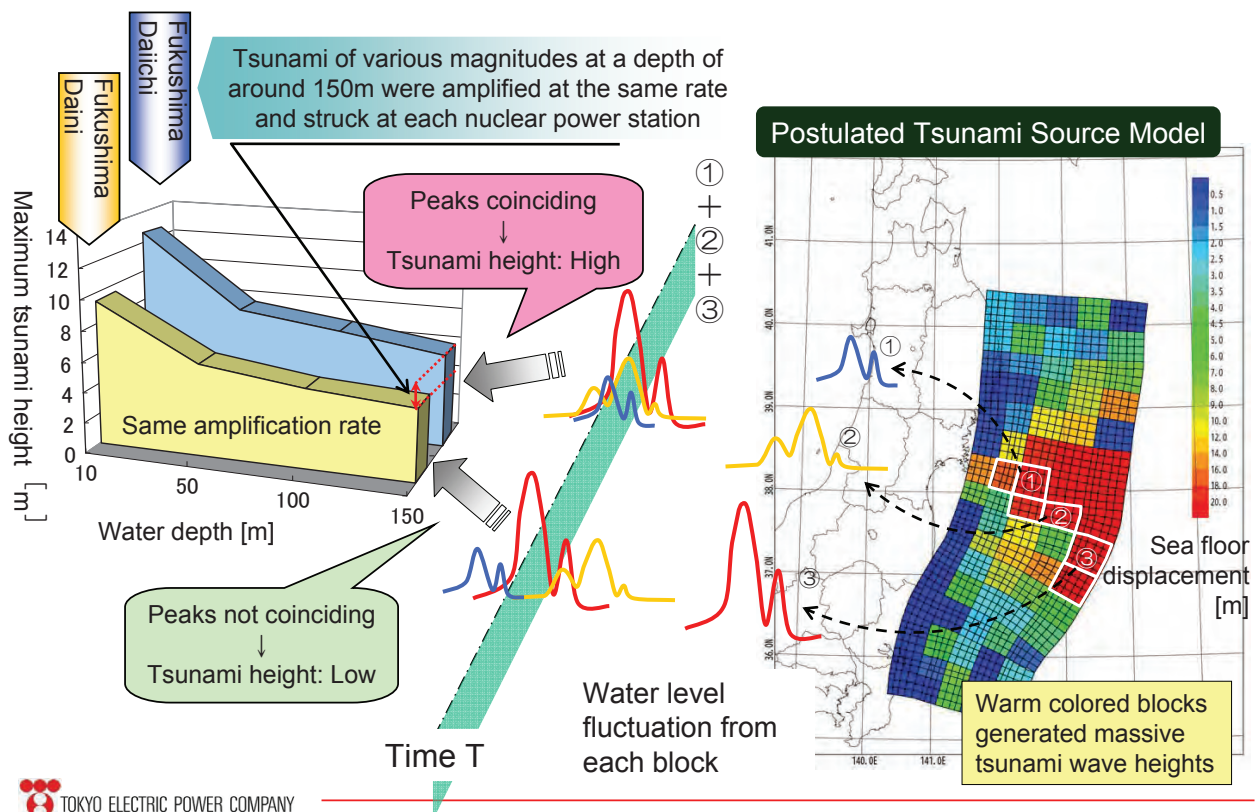

Damages of transmission line & Shinfukushima substation by earthquake

Transmission tower collapse

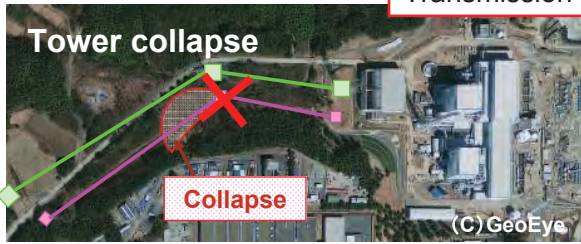

- About 10 km away from both 1F and 2F site
- Important switchgear station from which electricity of 1F & 2F was transmitted to Tokyo area



500kV Disconnector

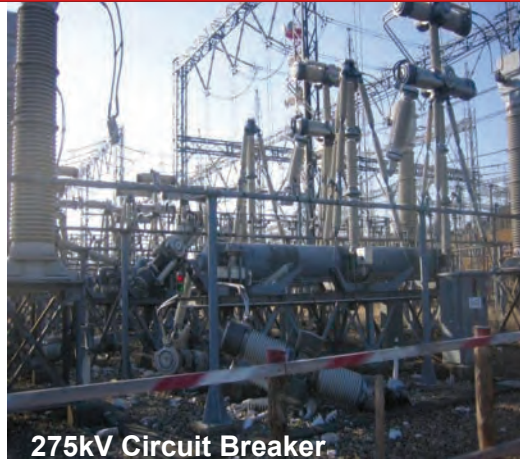

275kV Circuit Breaker



TOKYO ELECTRIC POWER COMPANY

All Rights Reserved ©2012The Tokyo Electric Power Company, Inc.

Power supply of Unit 1-4 @ 1F after Tsunami

Okuma Line 1L, 2L: Receiving circuit breaker damaged by earthquake

Okuma Line 3L: Renovation work in progress

Okuma Line 4L: Circuit breaker shutdown by protection relay activation

✗ Shutdown by earthquake
✗ Shutdown by Tsunami

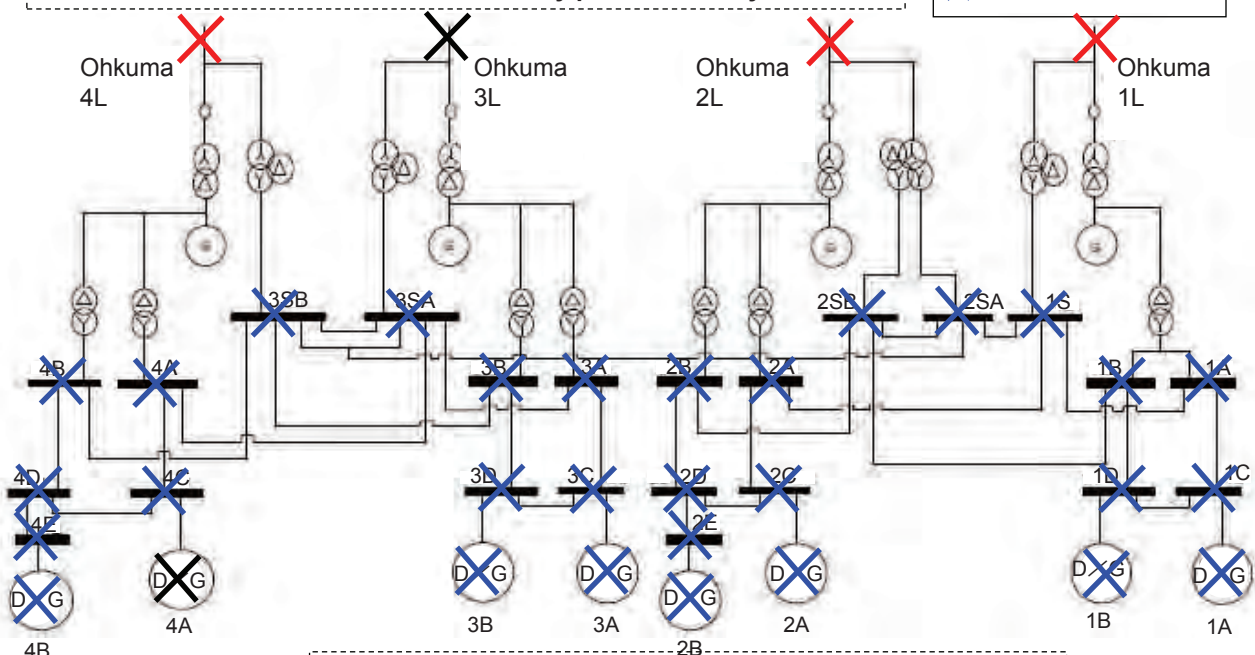

The DG lost the function due to either "M/C failure", "loss of sea water system," or "DG main unit failure."



TOKYO ELECTRIC POWER COMPANY

All Rights Reserved ©2012The Tokyo Electric Power Company, Inc.

Power supply of Unit 5/6 @ 1F after Tsunami

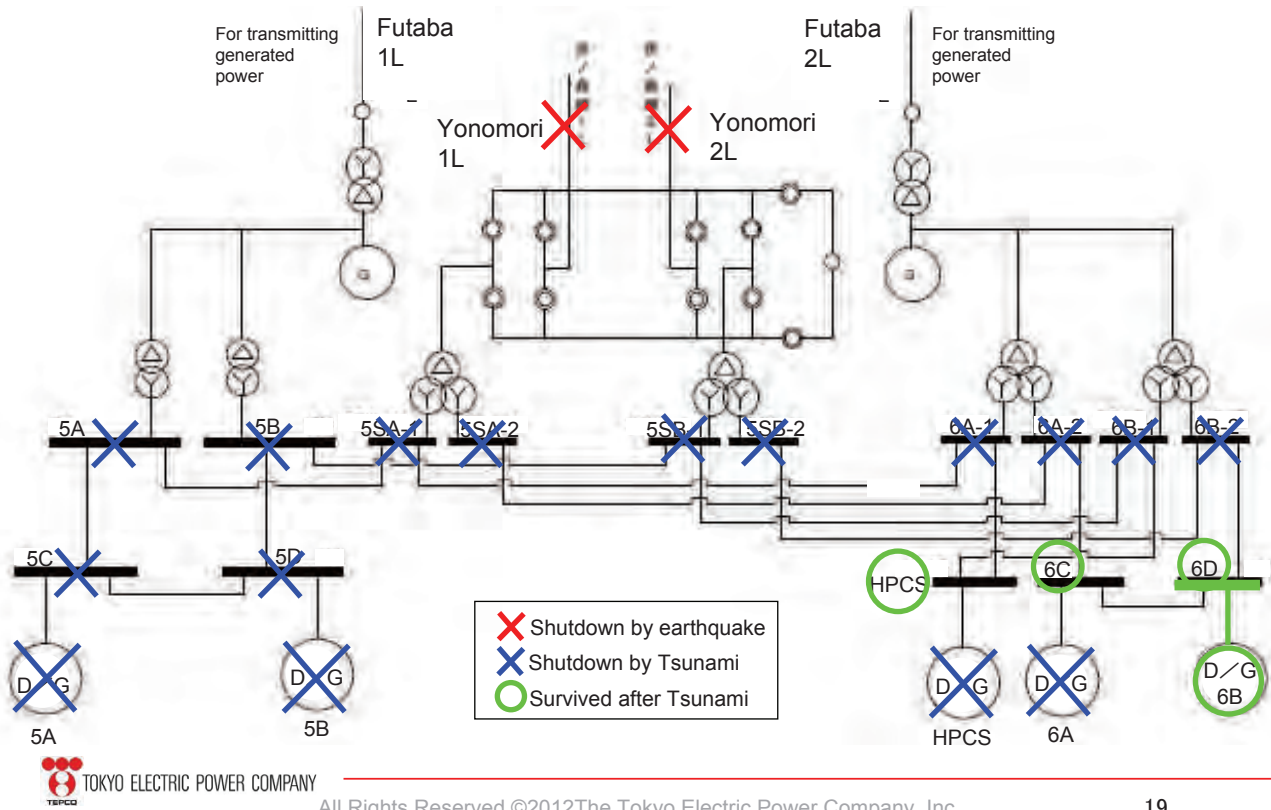

2F Offsite Power was secured even after Tsunami

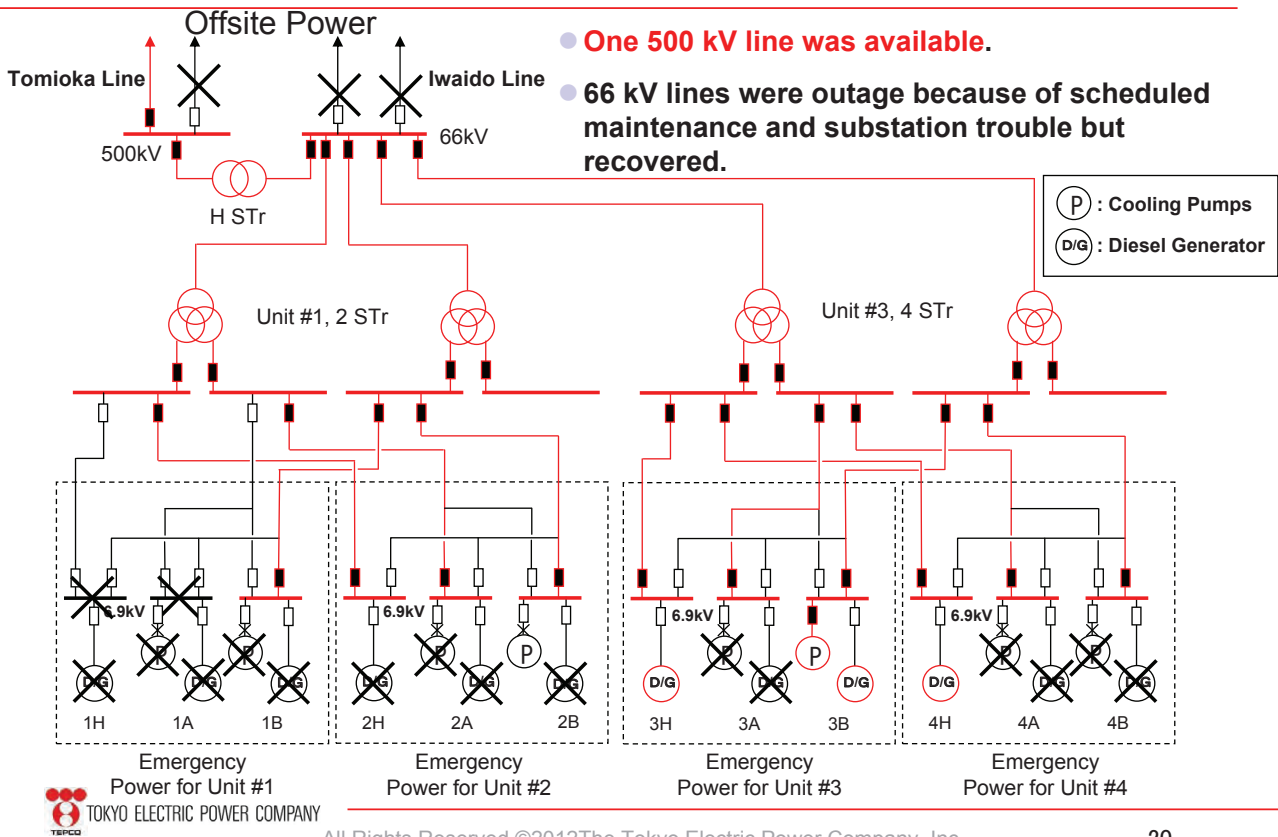

Integrity of Power Supply System After Tsunami at 1F and 2F

1F: No off-site power available

2F: Off-site power survived

Fukushima Daiichi													Fukushima Daini												
		Unit 1		Unit 2		Unit 3		Unit 4		Unit 5		Unit 6		Unit 1		Unit 2		Unit 3		Unit 4					
		Power panel	Can/can not be used	Power panel	Can/can not be used	Power panel	Can/can not be used	Power panel	Can/can not be used	Power panel	Can/can not be used	Power panel	Can/can not be used	Power panel	Can/can not be used	Power panel	Can/can not be used	Power panel	Can/can not be used	Power panel	Can/can not be used				
DG	3	DG 1A	x	DG 2A	x	DG 3A	x	DG 4A	x	DG 5A(*2)	x	DG 6A	x(*2)	DG 1A	x	DG 2A	x(*2)	DG 3A	x(*2)	DG 4A	x(*2)				
		DG 1B	x	DG 2B (air-cooled)	x(*1)	DG 3B	x	DG 4B (air-cooled)	x(*1)	DG 5B(*2)	x	DG 6B (air-cooled)	o	DG 1B	x	DG 2B	x(*2)	DG 3B	o	DG 4B	x(*2)				
													DG 1H	x	DG 2H	x(*2)	DG 3H	o	DG 4H	o					
6.9kV M/C	Emergency use	M/C 1C	x	M/C 2C	x	M/C 3C	x	M/C 4C	x	M/C 5C	x	M/C 6C	o	M/C 1C	x	M/C 2C	o	M/C 3C	o	M/C 4C	o				
		M/C 1D	x	M/C 2D	x	M/C 3D	x	M/C 4D	x	M/C 5D	x	M/C 6D	o	M/C 1D	o	M/C 2D	o	M/C 3D	o	M/C 4D	o				
													M/C 1H	x	M/C 2H	o	M/C 3H	o	M/C 4H	o					
6.9kV M/C	Regular use	M/C 1A	x	M/C 2A	x	M/C 3A	x	M/C 4A	x	M/C 5A	x	M/C 6A-1	x	M/C 1A-1	o	M/C 2A-1	o	M/C 3A-1	o	M/C 4A-1	o				
		M/C 1B	x	M/C 2B	x	M/C 3B	x	M/C 4B	x	M/C 5B	x	M/C 6B-1	x	M/C 1B-1	o	M/C 2B-1	o	M/C 3B-1	o	M/C 4B-1	o				
		M/C 1S	x	M/C 2SA	x	M/C 3SA	x			M/C 5SA-1	x	M/C 6A-2	x	M/C 1A-2	o	M/C 2A-2	o	M/C 3A-2	o	M/C 4A-2	o				
				M/C 2SB	x	M/C 3SB	x			M/C 5SB-1	x	M/C 6B-2	x	M/C 1B-2	o	M/C 2B-2	o	M/C 3B-2	o	M/C 4B-2	o				
										M/C 5SB-2	x			M/C 1B-2	o	M/C 2B-2	o	M/C 3B-2	o	M/C 4B-2	o				
480V PC	Emergency use	P/C 1C	x	P/C 2C	o	P/C 3C	x	P/C 4C	o	P/C 5C	x	P/C 6C	o	P/C 1C-1	x	P/C 2C-1	o	P/C 3C-1	o	P/C 4C-1	o				
		P/C 1D	x	P/C 2D	o	P/C 3D	x	P/C 4D	o	P/C 5D	x	P/C 6D	o	P/C 1C-2	x	P/C 2C-2	x	P/C 3C-2	x	P/C 4C-2	x				
													P/C 1D-1	o	P/C 2D-1	o	P/C 3D-1	o	P/C 4D-1	o					
		P/C 1A	x	P/C 2A	x	P/C 3A	x	P/C 4A	o	P/C 5A	x	P/C 6A-1	x	P/C 1D-2	x	P/C 2D-2	x	P/C 3D-2	x	P/C 4D-2	x				
													P/C 1A-1	o	P/C 2A-1	o	P/C 3A-1	o	P/C 4A-1	o					
		P/C 1B	x	P/C 2B	o	P/C 3B	x	P/C 4B	o	P/C 5B	x	P/C 6B-1	x	P/C 1A-2	o	P/C 2A-2	o	P/C 3A-2	o	P/C 4A-2	o				
													P/C 1B-1	o	P/C 2B-1	o	P/C 3B-1	o	P/C 4B-1	o					
		P/C 1S	x			P/C 3SA	x			P/C 5SA	x			P/C 1B-2	o	P/C 2B-2	o	P/C 3B-2	o	P/C 4B-2	o				
										P/C 5SA-1	x			P/C 1SA	o			P/C 3SA	o						
						P/C 2SB	x	P/C 3SB	x			P/C 5SB	x			P/C 1SB	o			P/C 3SB	o				
DC	125V/DC	DC125V main bus panel A	x	DC125V P/C 2A	x	DC125V main bus panel 3A	o	DC125V main bus panel 4A	x	DC125V P/C 5A	o	DC125V DIST CENTER 6A	o	DC125V main bus panel A	o	DC125V main bus panel B	o	DC125V main bus panel A	o	DC125V main bus panel B	o				
		DC125V main bus panel B	x	DC125V P/C 2B	x	DC125V main bus panel 3B	o	DC125V main bus panel 4B	x	DC125V P/C 5B	o	DC125V DIST CENTER 6B	o	DC125V main bus panel A	o	DC125V main bus panel B	o	DC125V main bus panel A	o	DC125V main bus panel B	o				
Sea Water System	SW			RHRS A	x	RHRS A	x	RHRS A	x	RHRS A	x	RHRS A	x	RHRS A	x	RHRS A	x	RHRS A	x	RHRS A	x				
				RHRS B	x	RHRS B	x	RHRS B	x	RHRS B	x	RHRS B	x	RHRS B	x	RHRS B	x	RHRS B	x	RHRS B	x				

Sea Water System

O: operable X: damaged



TOKYO ELECTRIC POWER COMPANY

1 functionality lost due to inundation of power panels *2 functionality lost due to the damage of sea water system
All Rights Reserved ©2012The Tokyo Electric Power Company, Inc.

1F Unit 1 Schematic System Diagram (After Tsunami)

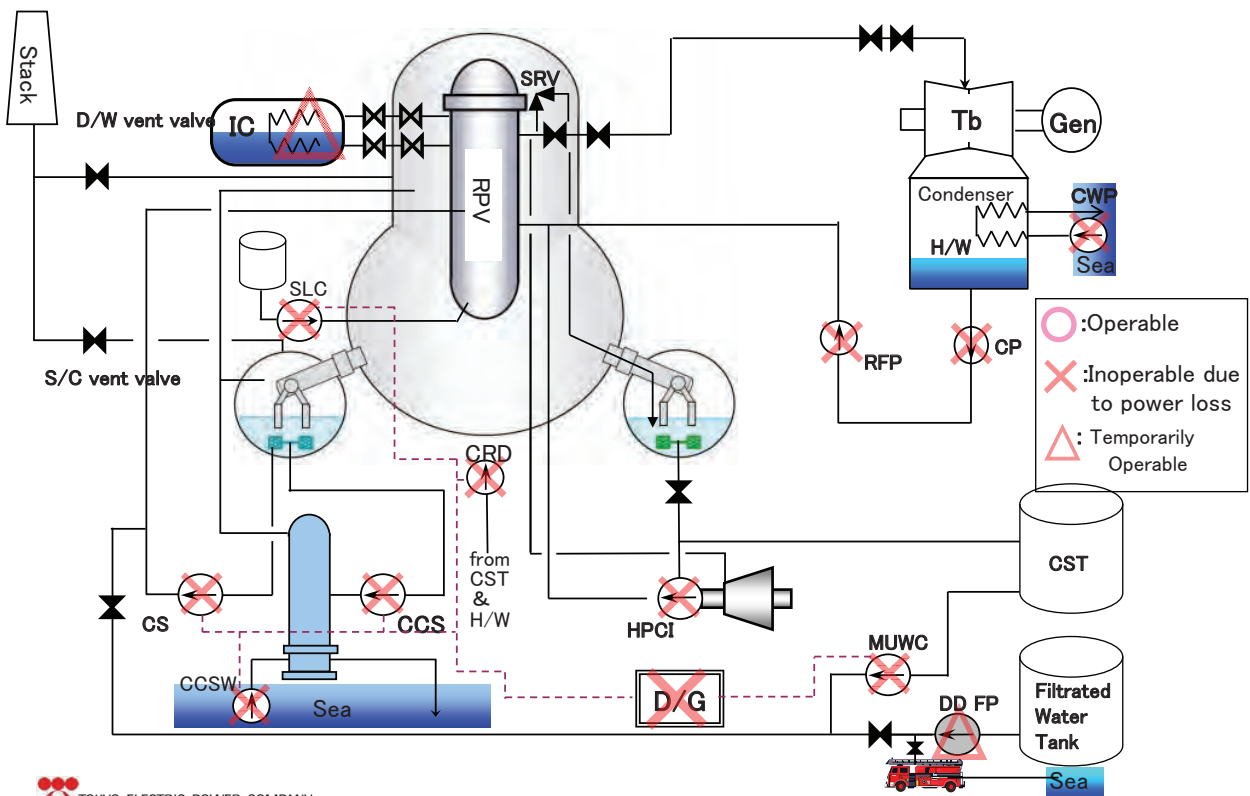

1F Unit 2 Schematic System Diagram (After Tsunami)

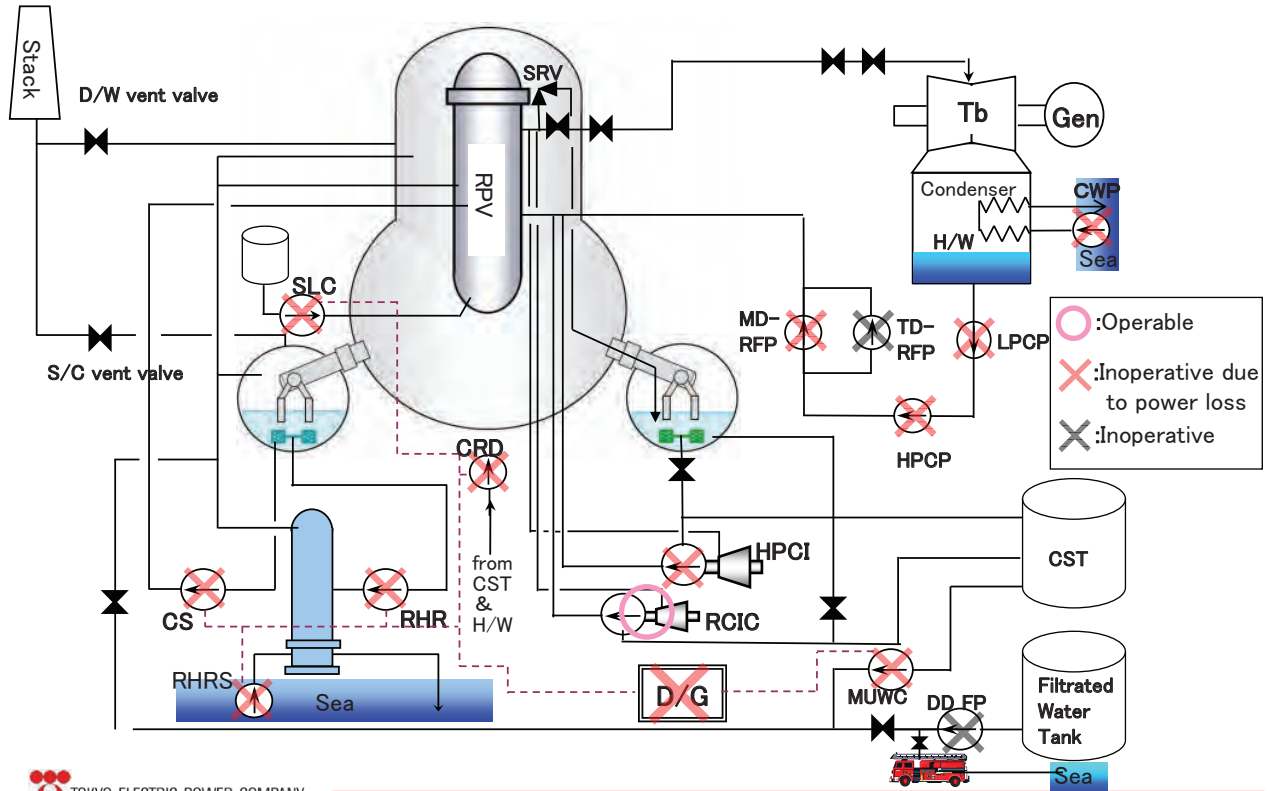

1F Unit 3 Schematic System Diagram (After Tsunami)

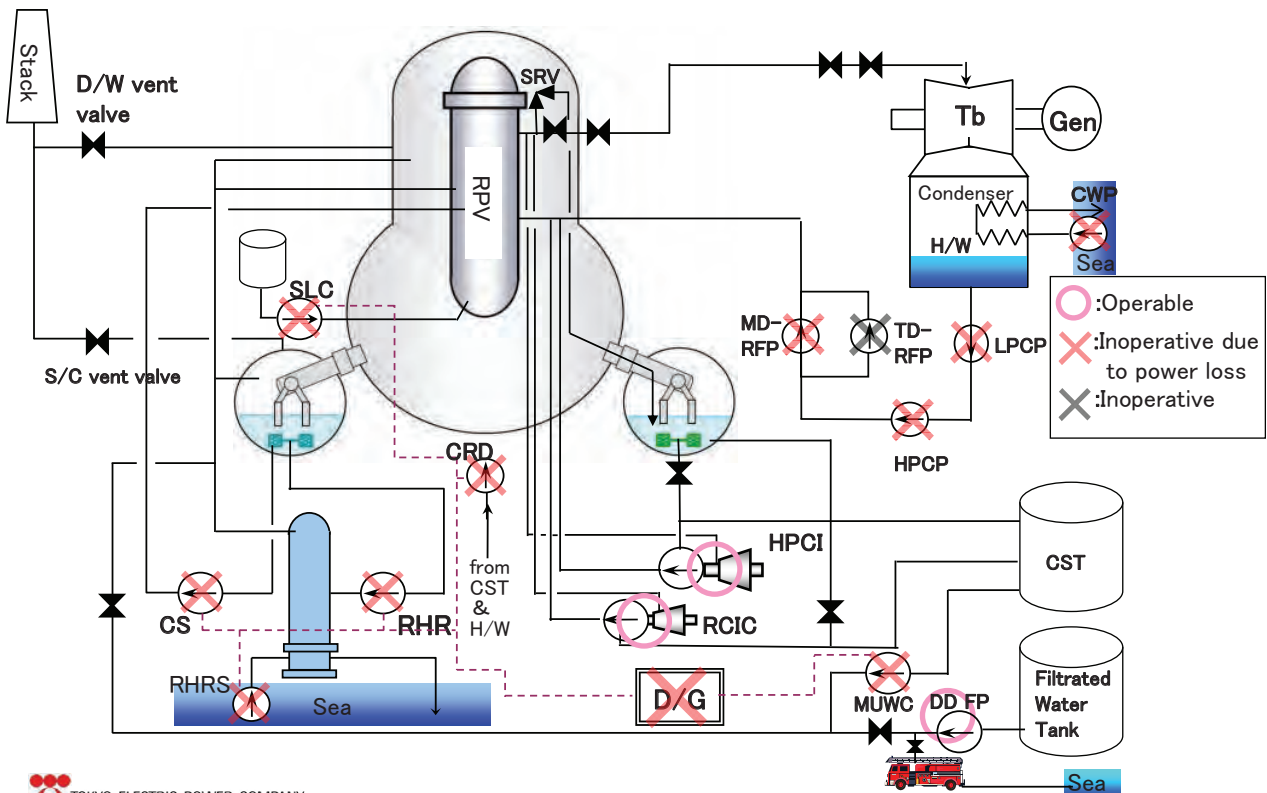

2. How we responded.

- How the accident developed
- What difficulties existed
- What were effectively utilized

Status of 1F 1-3 immediately after Tsunami

■ Fallen into the **Station Black Out (SBO)**:

- ◆ All safety and non-safety systems driven by electricity were unavailable.
- ◆ **No lights** in the control rooms, R/Bs, T/Bs, etc.
- ◆ **No important instrumentations** for Unit 1 &2 due to loss of AC power sources and DC 125V batteries; the reactor water level/ pressure, drywell pressure, wet-well (S/C) pressure, etc. ; **Operators were totally blind!**
- The instrumentation of Unit 3 was available immediately after the tsunami but only lasted for about 30hours because the DC 125V battery charger was flooded.
- ◆ **No communication tools** between the Emergency Response Room and workers at the field: only hotline and land-line phone were available between the ERR and each control room.

■ The sea water systems were totally destroyed: **No Ultimate Heat Sink**

Overview of the 10-Unit Simultaneous Accidents

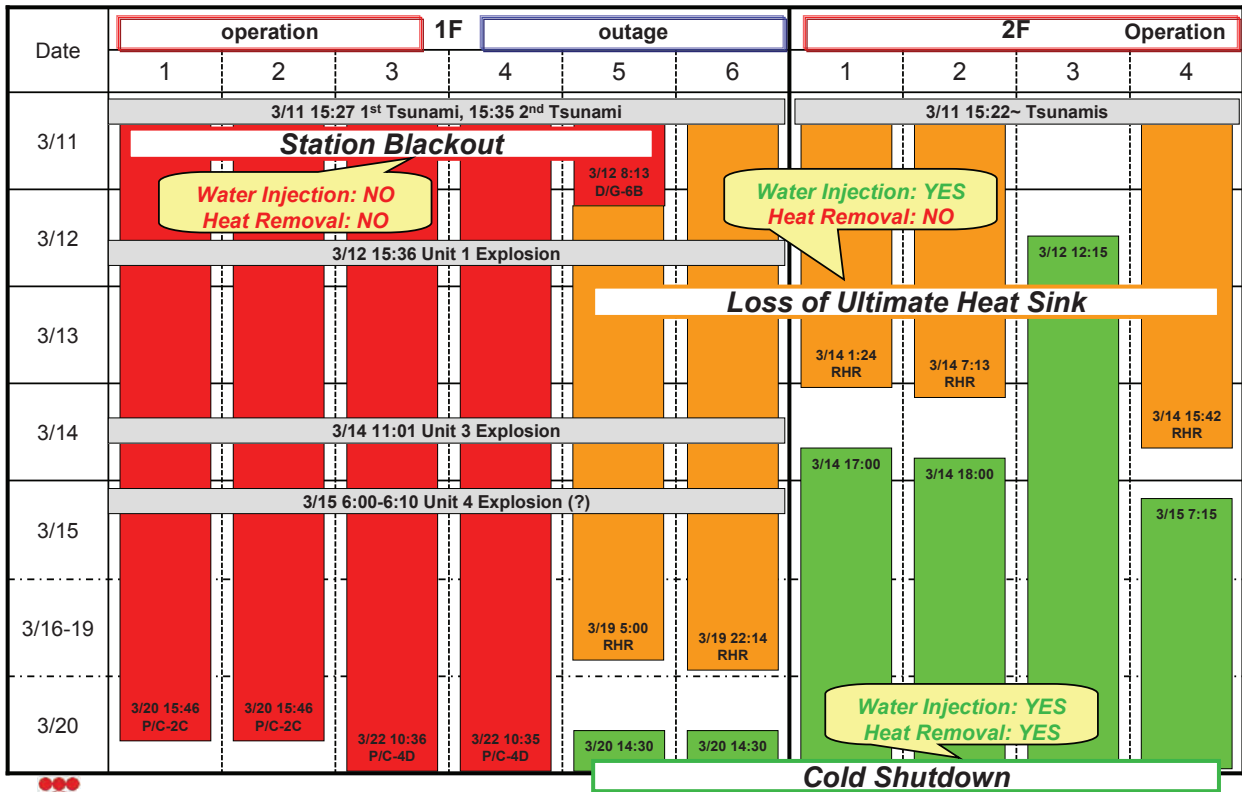

1F-1 Plant Parameter and Operation

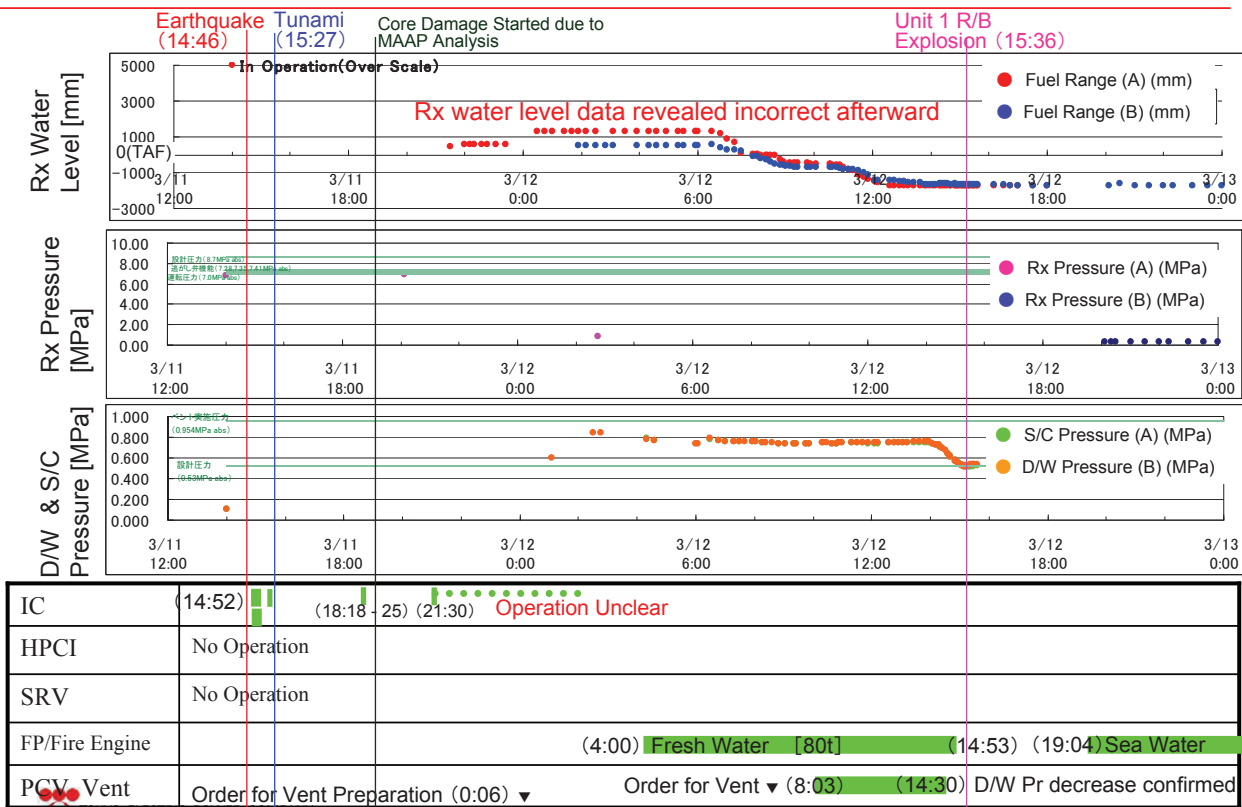

1F-2 Plant Parameter and Operation

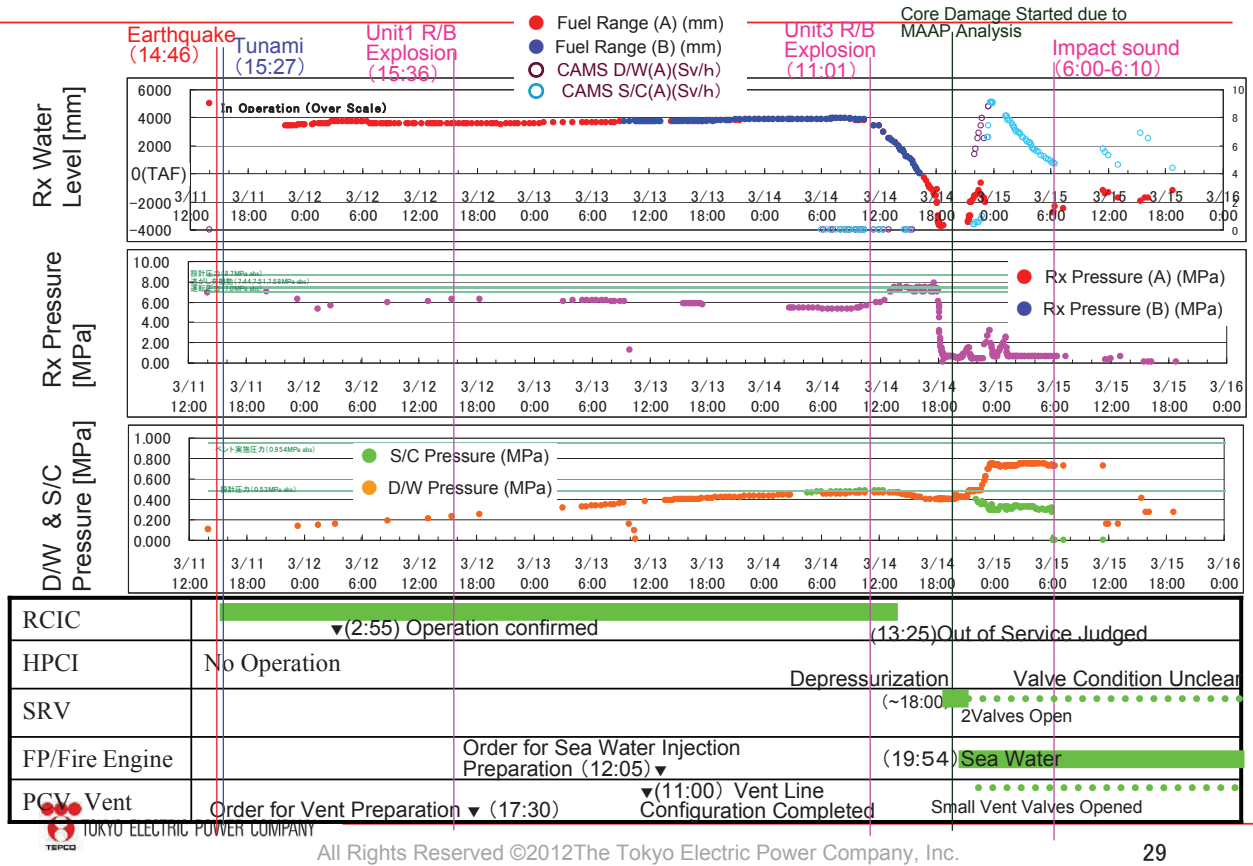

1F-3 Plant Parameter and Operation

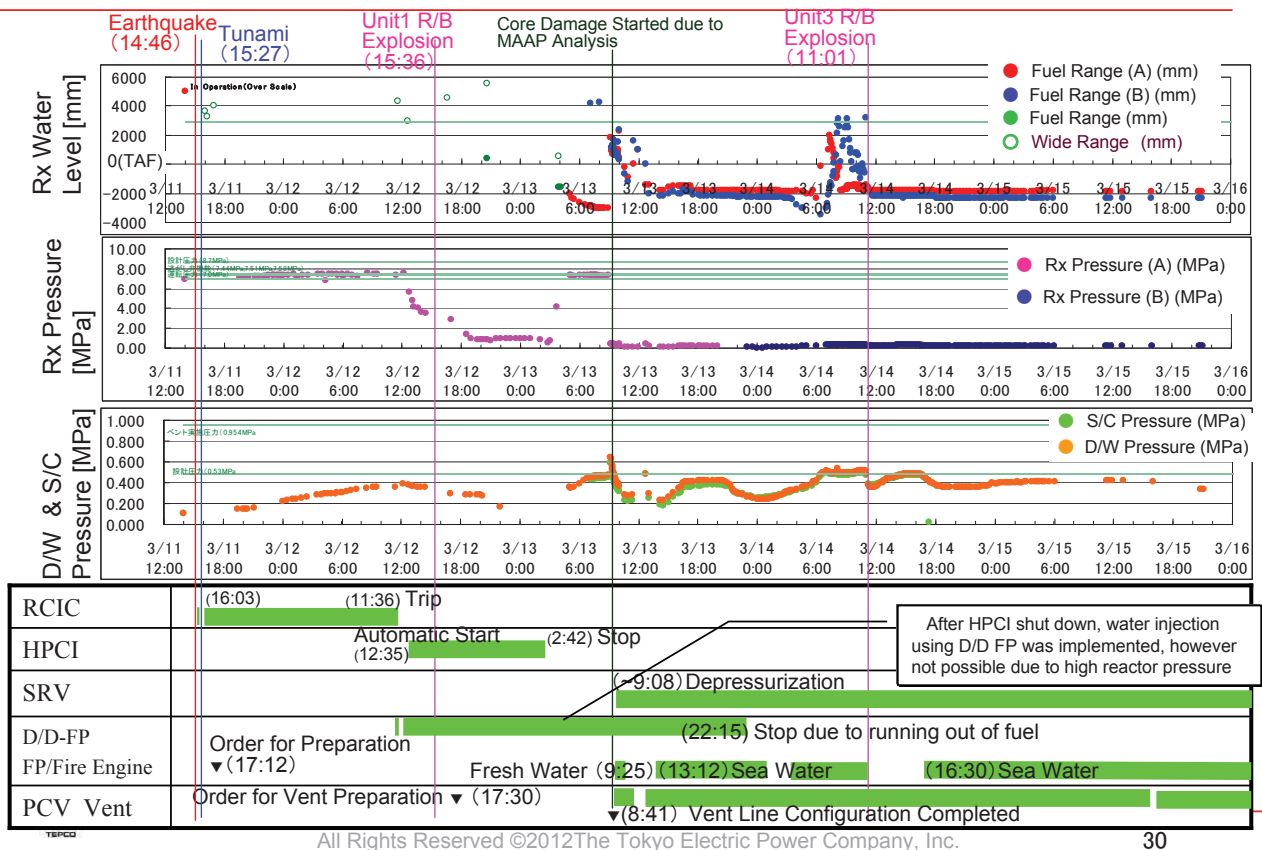

(Ref.) 1F- 1 Plant Parameter and Operation

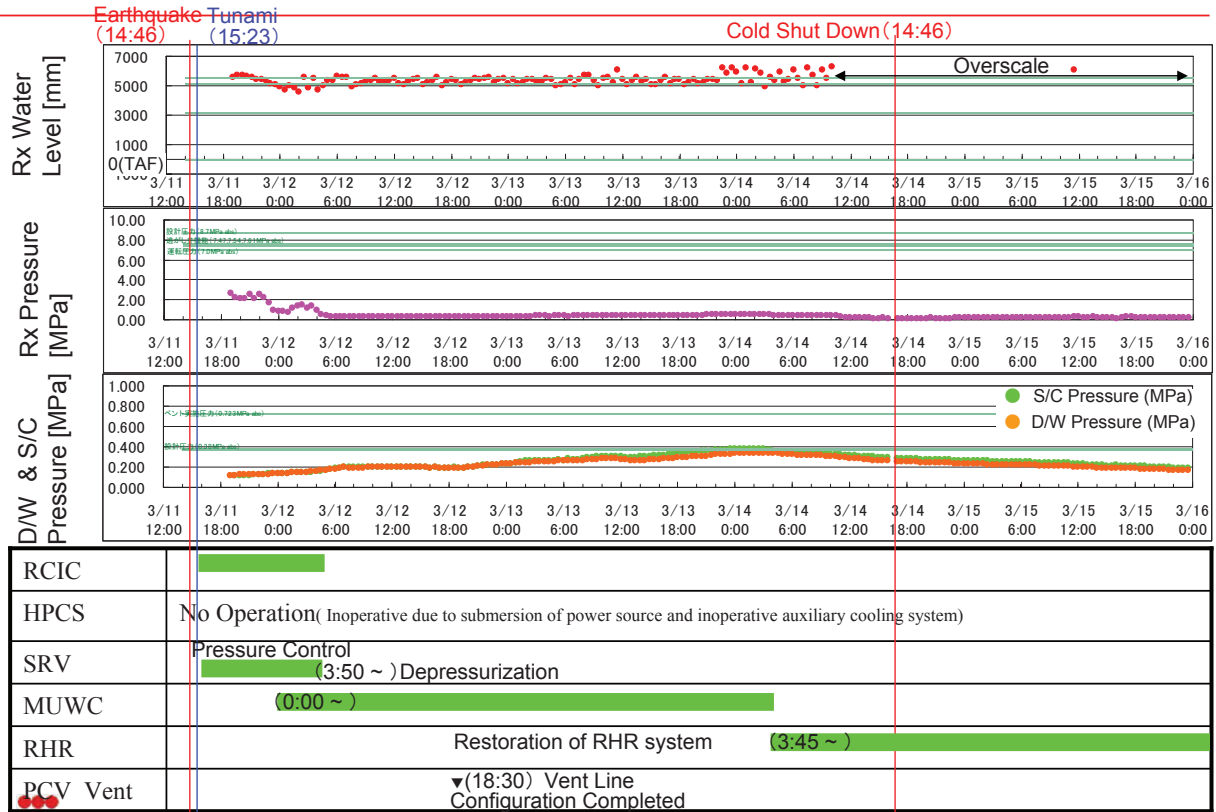

TOKYO ELECTRIC POWER COMPANY

All Rights Reserved ©2012The Tokyo Electric Power Company, Inc.

Major Activities at 1F

~ Factors disturbing the recovery work (inside the building) ~

Scram response

Deteriorated operability due to the tsunami

Preparations for water injection

Preparations for venting

Water injection started

Venting

Due to lack of power sources, initial recovery activities had to be conducted in the complete darkness, without any instrumentation, and without most communications means.

Work in complete darkness.
Many scattered objects were also on the floor.

Connected temporary batteries to recover instrumentations.



TOKYO ELECTRIC POWER COMPANY

All Rights Reserved ©2012The Tokyo Electric Power Company, Inc.

Major Activities at 1F

~Factors disturbing the recovery work (inside the buildings) ~

Scram response

Deteriorated operability due to the tsunami

Preparations for water injection

Preparations for venting

Water injection started

Venting

Instruments were monitored wearing a full face mask with a flashlight in complete darkness

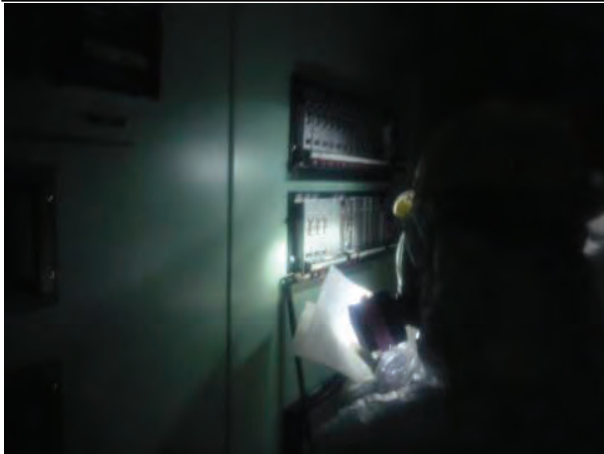

Checking instrumentation only with a flashlight in complete darkness

Supervising at a deputy supervisor's desk wearing a full face mask in complete darkness

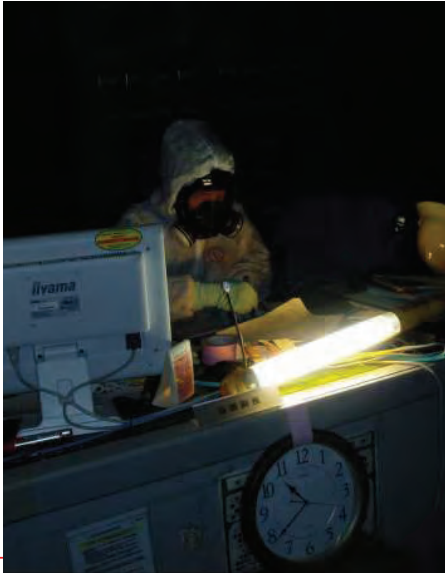

TOKYO ELECTRIC POWER COMPANY

All Rights Reserved ©2012The Tokyo Electric Power Company, Inc.

33

Major Activities at 1F

~Factors disturbing initial recovery of instrumentations and power supply ~

Scram response

Deteriorated operability due to the tsunami

Preparations for water injection

Preparations for venting

Water injection started

Venting

- Used **batteries taken from cars** for recovery of important instrumentations.
- Put **Engine-Generators** to provide power for the **control room lightings** and **PCV vent valve actuation**.
- Tried to connect a **mobile power supply vehicle** to **P/C 2C** with temporary cable. The hydrogen explosion of Unit 1 caused damage of the temporary cable.
- Hurdles for the work:
 - ◆ **Darkness and suspensions due to aftershocks, tsunami alarms,**
 - ◆ **Puddles, openings of manholes, debris and other obstacles caused by the tsunami,**
 - ◆ **Influence of the hydrogen explosions**

Image of a power supply vehicle



TOKYO ELECTRIC POWER COMPANY

All Rights Reserved ©2012The Tokyo Electric Power Company, Inc.

34

Major Activities at 1F

~ Factors disturbing alternative water injection into the reactors

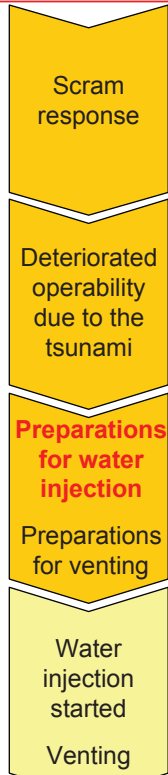

1. Tried to inject fresh water using the diesel driven fire protection pump (DDFP): failed.
 - ◆ Unit 1: mechanical problem of the DDFP
 - ◆ Unit 2: the DDFP was flooded
 - ◆ Unit 3: the RPV pressure was too high
2. Injection of fresh water from underground water tank (16units/site × 40m³/unit) using the fire engine pumps : succeeded, but did not last for long time
3. Injection of sea water using the fire engine pumps.
 - Hurdles for the work:
 - ◆ Interruptions due to aftershocks and tsunami alarms
 - ◆ Damages of the fresh water lines due to the earthquake
 - ◆ Debris and damages of the gates caused by the tsunami
 - ◆ R/B explosions (debris, damage of fire engines and other devices, injury of field workers and fear of another explosion)
 - ◆ No lights. Problem with the PHS telephone and radio communication



Major Activities at 1F

~ Factors disturbing the recovery work (outside the buildings) ~

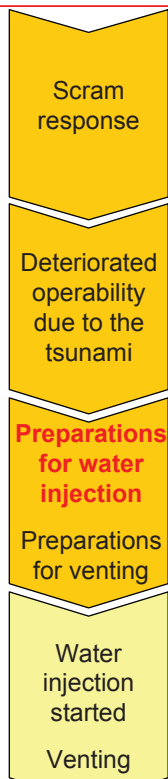

- Many obstacles on access routes disturbed access to the field.
- Vehicles had to avoid passing over fire protection hoses laid in the field.
- Most of the prepared communication tools between the ERC and the control room were unavailable.



Major Activities at 1F

~ Factors disturbing the Primary Containment Vessel Venting Operation

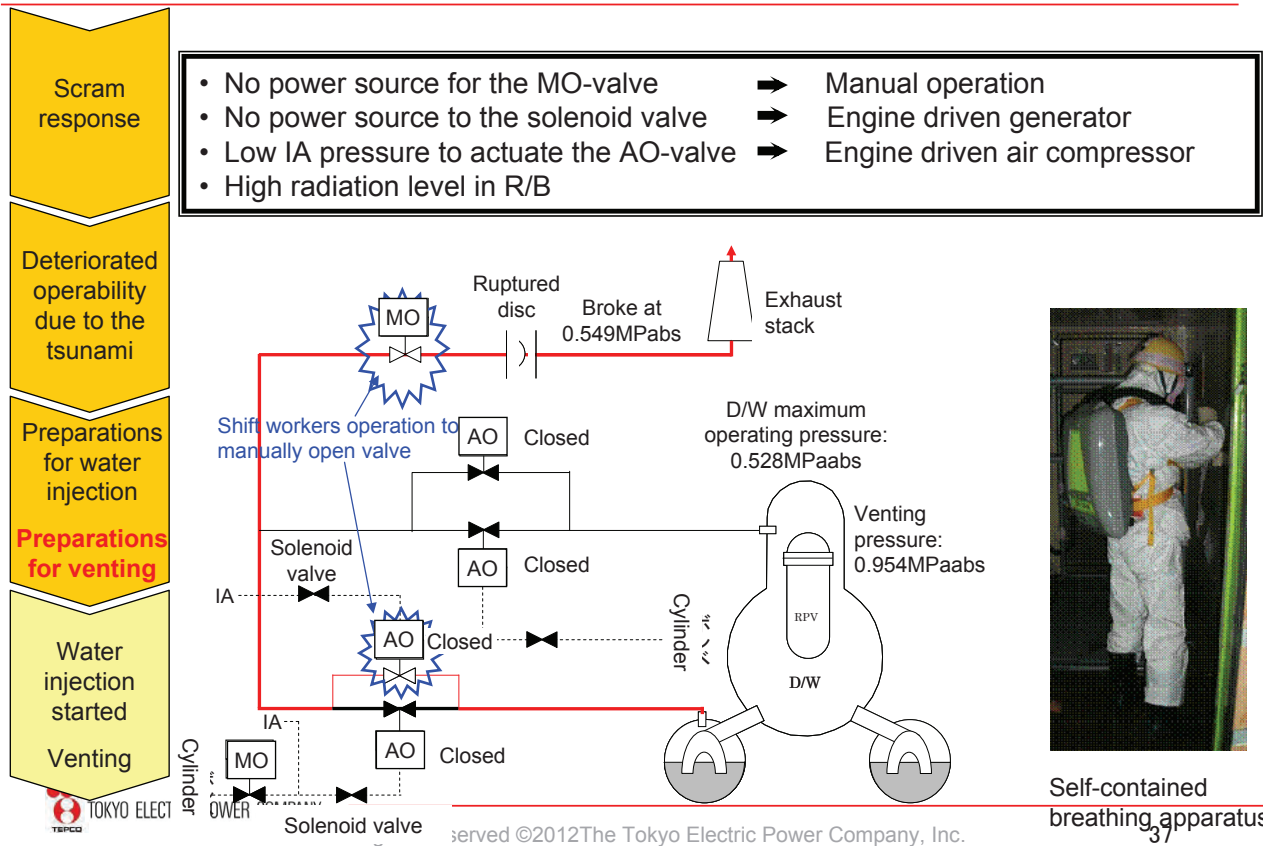

Testimonies from the Field

- “In an attempt to check the status of Unit 4 D/G, I was trapped inside the security gate compartment. Soon the tsunami came and **I was a few minutes before drowning**, when my colleague smash opened the window and saved my life.”
- “The radiation level in the main control room was increasing 0.01 mSv (1 mrem) every 3 seconds but I couldn’t leave—**I felt this was the end of my life.**”
- “I asked for volunteers to manually open the vent valves. **Young operators raised their hands** as well.”
- “Unit 3 could explode anytime soon, but it was my turn to go to the main control room. **I called my dad and asked him to take good care of my wife and kids should I die.**”



Unit 5 Torus Room



Unit 1 Main Control Room

D/G: Diesel Generator
 SRV: Safety Relief Valve
 S/C: Suppression Chamber

3. Other Relevant Issues



How the Pre-planned Accident Management Worked (The Tsunami was beyond AM)

Facilities	Outline	Practical use at 1F-1~3	at 2F-1
1. Shutdown	①Recirculation Pump Trip ②Alternative Rod Insertion	—:(CRs are fully inserted)	—
2. Injecting water	①Alternative Injection by MUWC /FP	○:Injected from AM coupler △:Using Fire engine (MUWC & FP are downed as loss of AC power etc.)	○
	②Automatic ADS	× :Manual operated as loss of power	—
3.Containment Cooling	①Alternative Cooling by Drywell Cooler	× :Inoperable as loss of AC power	○
	②Restoration of CCS		
	③Hardened Vent	△: Manual operated	(prepared line up)
4. Support of Safety Facilities	① Interchangeability of 6.9kV & 480V Power Sources	× : Inoperable as loss of power including the next(1~4) plant (But operable 1F-5,6 BUS tie)	○
	② Restoration Procedure Guidelines (RHR & D/G)	× : Cooling and Electric supply facilities are Inoperable	—

— : no relation × : couldn't apply △ : partially apply ○ : apply



Presumption of Reactor Core State by Analysis Code (MAAP) etc.

1F- 1

- Almost no fuel was left at the original position, and fuel **completely moved downward** after it damaged.
- The moved fuel **likely damaged RPV** and is assumed that most of it had dropped to the bottom of PCV.
- Dropped fuel is assumed to have **caused core concrete interaction**.
- As of Nov.21, water injection is conducted through the feed water system and the temperature at bottom as well as inside the PCV remain stable below 100°C.
- Therefore, it is evaluated that **all the moved fuel is expected to be cooled directly by water injection**. It is also evaluated that the **core concrete interaction has been stopped**.

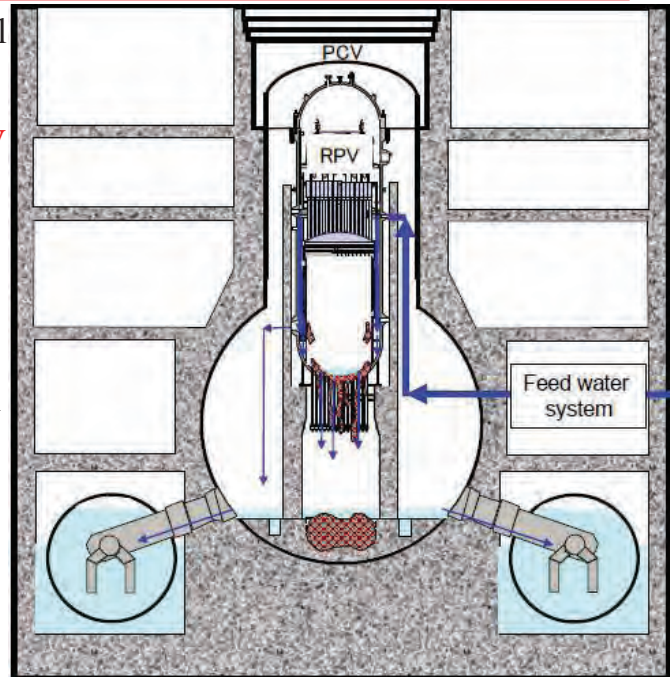

Erosion depth by core concrete interaction:
0.65m

Presumption of Reactor Core State by Analysis Code (MAAP) etc.

1F- 2 & 3

- Even though the fuel was damaged, it is assumed that there has been no large damage of the RPV that would make a large amount of fuel dropped to the bottom of PCV.
- **There is a range in the evaluation result from “part of damaged fuel dropped to the bottom of PCV” to “Almost all the fuel is left inside RPV”.**
- If the part of damaged fuel were to have dropped to the bottom of PCV, it can be assumed that core concrete interaction was caused.
- Currently, water injection is conducted through the feed water system and CS system. The temperature in the PCV remain stable below 100°C.
- Therefore, it is evaluated that **all the moved fuel is expected to be cooled directly by water injection**. It is also evaluated that the **core concrete interaction has been stopped**.

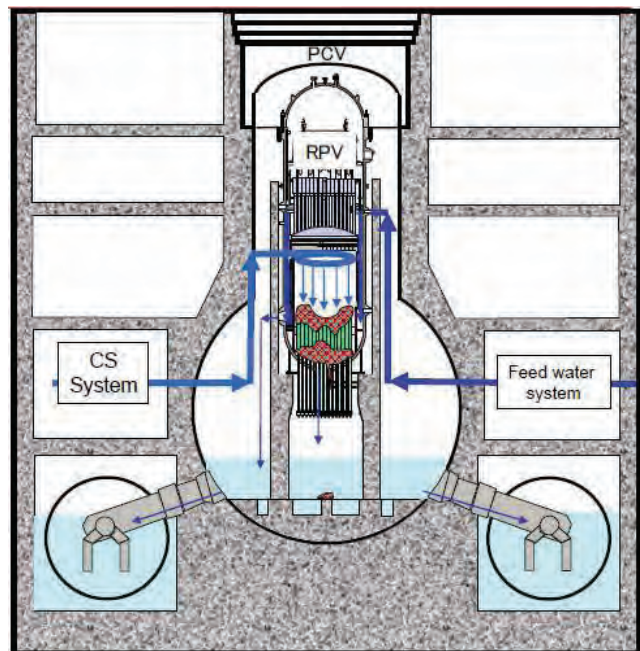

Erosion depth by core concrete interaction:
Unit 2: 0.12m
Unit 3: 0.20m

Hydrogen Explosions at 1F-1 and 3 R/B

- Hydrogen is supposed to have leaked through heat affected seals on the D/W flange, hatch and electric penetrations.

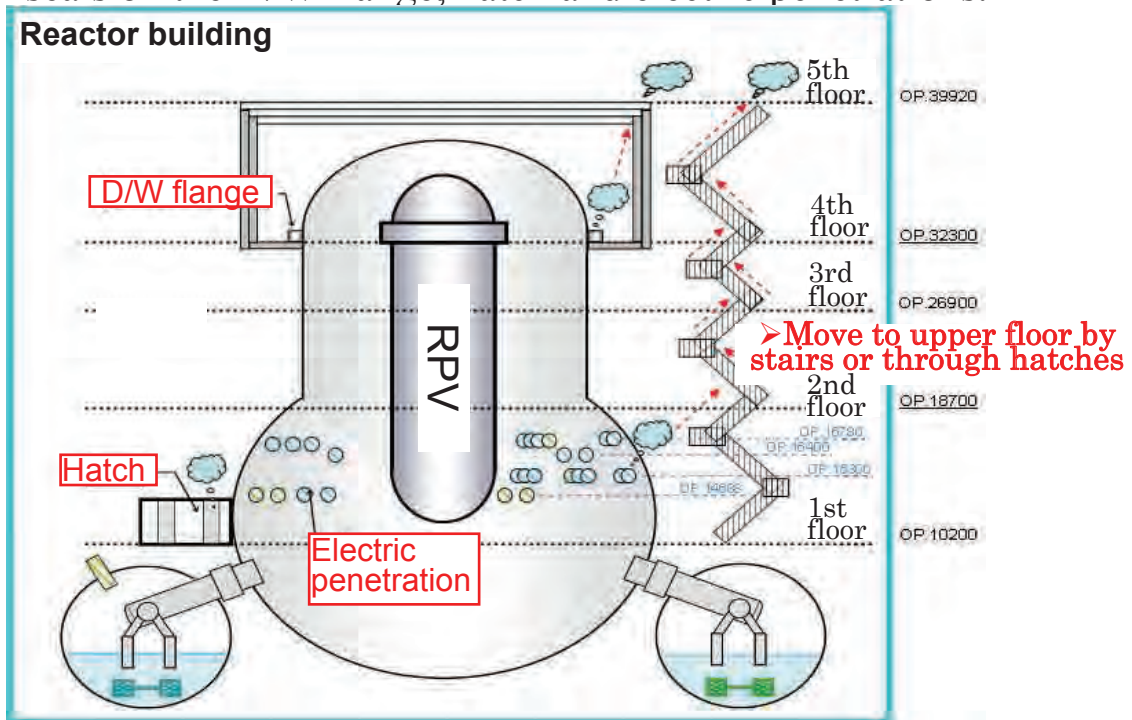

Hydrogen Explosion at 1F-4 R/B

- Hydrogen generated in the Unit 3 reactor back-flowed into Unit 4 through SGTS line.

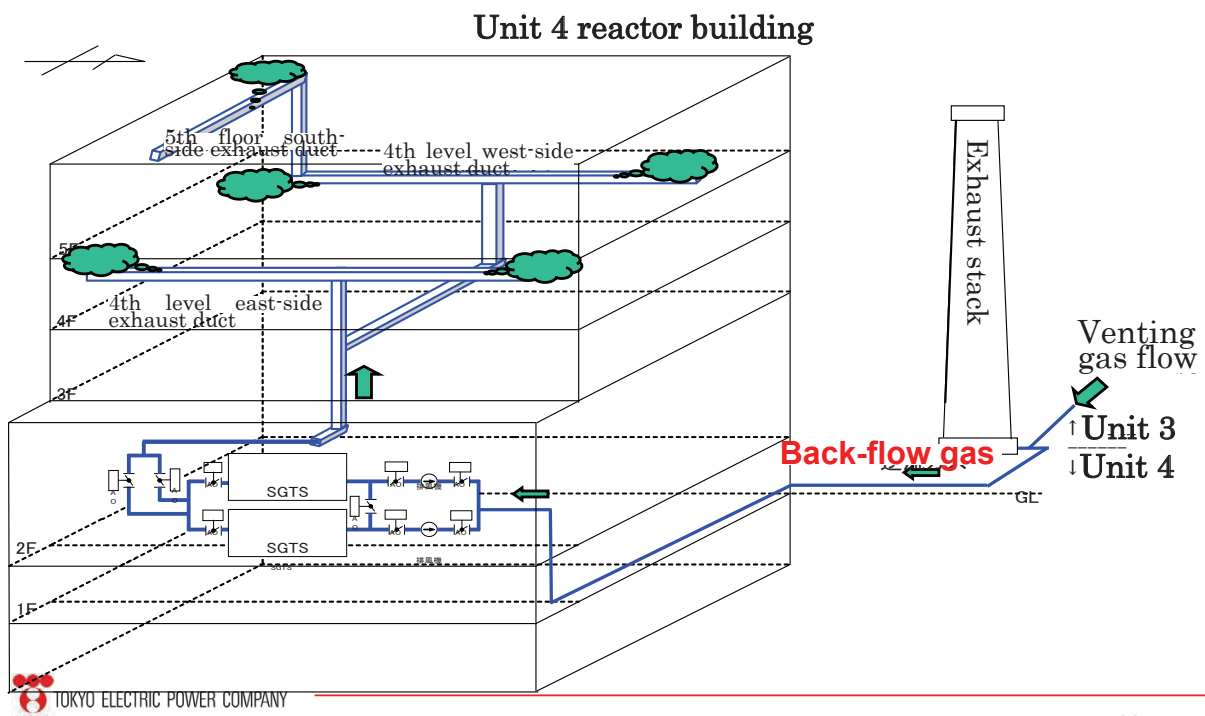

Measurement Result of 1F-4 SGTS Radiation Dose

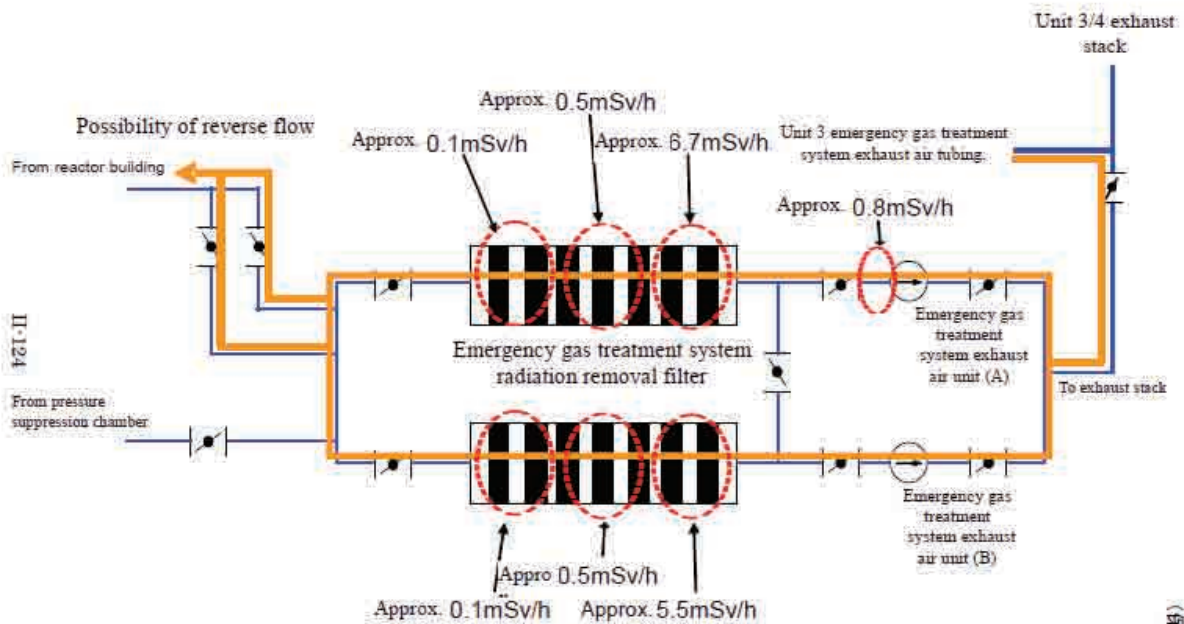
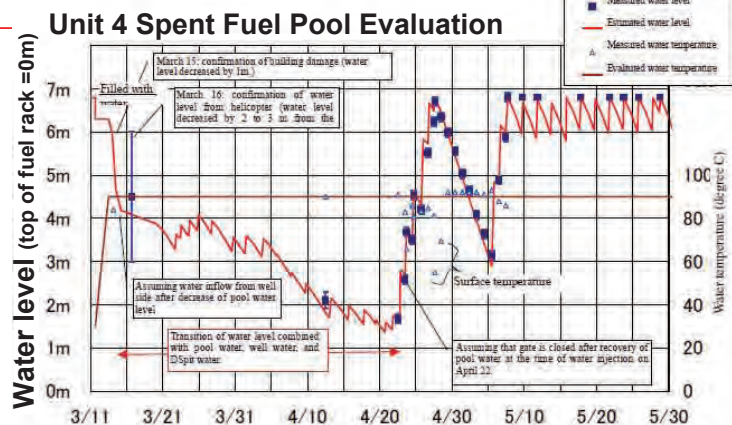

Figure II-2-37 Measurement Result of Unit 4 SGTS Radiation Dose (Measured in August 25, 2011)

(保安院)

Number of Stored Fuel Assemblies and Decay Heat in Spent Fuel Pool (SFP)

- LOPA caused loss of cooling
- Largest Heat load in Unit 4, but Rx well and DS pit was full
- Water injected by helicopter, fire engines, and then concrete pumps
- No fuel was uncovered in any pools
- Now all pools are cooled by heat exchangers



	Stored fuel assemblies		Decay heat (MW)	
	Irradiated fuel	Fresh fuel	As of March 11	As of June 11
Unit 1 SFP	292	100	0.18	0.16
Unit 2 SFP	587	28	0.62	0.52
Unit 3 SFP	514	52	0.54	0.46
Unit 4 SFP	1331	204	2.26	1.58
Unit 5 SFP	946	48	1.01	0.76
Unit 6 SFP	876	64	0.87	0.73
Common SFP	6375	0	1.13	1.12

Conditions of SFPs

Unit 3 SFP (Water surface and underwater)

Unit 4 SFP (Water surface and underwater)



As many debris have fallen into the SFP, the status of the fuel racks and fuels can not be confirmed.

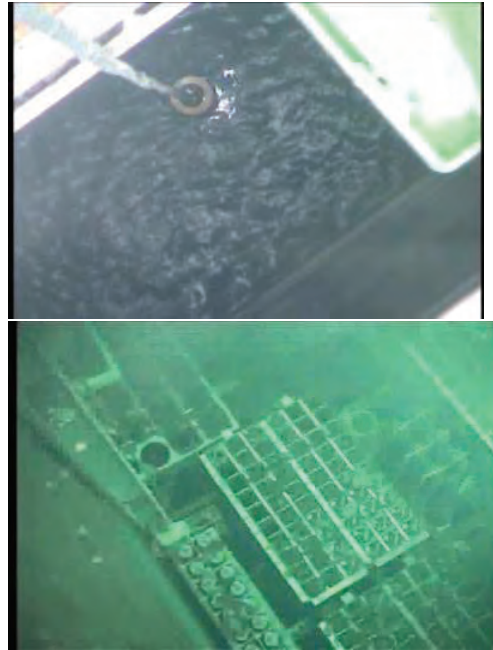

Although some debris have fallen into the SFP, it can be confirmed that the status of the fuel racks and fuels are normal.



TOKYO ELECTRIC POWER COMPANY

All Rights Reserved ©2012The Tokyo Electric Power Company, Inc.

47

Condition of Spent Fuel Pool and Fuel

- Water level has not reached low enough to cause damage of fuel
- No significant structural damage was identified, and inside is clean in Unit 4
- Water has activity, but it is evaluated that it comes from containment vent, condensed steam, or dust
- Some fuels may have been damaged due to debris falling into the pool, but it is unlikely that a large quantity of the fuel is damaged
- Now, pools are stably cooled by heat exchangers
- Majority of fuel stored in the pools is sound



TOKYO ELECTRIC POWER COMPANY

All Rights Reserved ©2012The Tokyo Electric Power Company, Inc.

48

The Japanese Emergency Response to the Accident

Toshio Fujishiro

**Research Organization for
Information Science and Technology**

Introduction

- Japanese emergency response program has been developed reflecting the lessons learned from severe accidents abroad and JCO accident occurred in Japan in 1999.
- Emergency response taken to the Fukushima Nuclear Power Plant Accident was executed under duplicated influence of nuclear accident and huge natural disaster.
- Procedures prepared in emergency response program were not fully applicable in the early stage of response.
- Under this difficult and confused condition, evacuation area was decided before radioactive material release.
- Early start of evacuation prevented high dose exposure though the experience left many hard lessons.

2

Development of Nuclear Emergency Programs in Japan (Historical Review)

1961.11 Basic Law for Emergency Preparedness

1979. 3 *TMI Accident*

1979. 6 NSC established Technical Advisory Group in Nuclear Emergency

1980. 6 NSC published “Guideline for Emergency Preparedness for NPPs”

1986. 4 *Chernobyl Accident*

1992. 5 NSC recommended preparation of Accident Management Countermeasures

1997. 3 *Explosion at Solid Waste Processing Plant in JNC*

1997. 6 Central Forum for Disaster Prevention modified “National Basic Emergency Plan” to strengthen Nuclear Emergency

1999. 4 - NSC, STA and MITI issued reports to strengthen their emergency programs

1999. 9 *JCO Accident*

1999.12 Government issued “Special Law for Nuclear Emergency”

2000. 5 NSC modified “Guideline for Emergency Preparedness”

Based on the special law 22 Off-site Centers and 2 Emergency Support Centers are established in the vicinity of NPPs, Technical Support Network are strengthened, and Nuclear Emergency Drills are performed periodically at national and local governments.

3



JCO Accident : Criticality accident at the Uranium Conversion Facility, JCO Co. Ltd, caused by adopting illegal procedures (Sept. 30, 1999)

Workers (3) were exposed to high radiation levels to death or severely injured, and general public adjacent to the plant were caused to exposure.

About 150 people close to the plant were advised to evacuate and the residents in 10 km area to remain indoors.



Top page of a newspaper, Oct. 1, 99

Outline of Emergency Preparedness Strengthened after JCO Accident

- **Extend the scope to include fuel cycle facilities, research reactors, etc. and clarify the roles and responsibilities of the national government, local governments and license holders**
- **Improve initial responses**
 - **define action levels by doze and specific initial events of NPPs**
 - **define the action procedures of national government**
- **Strengthen the national emergency preparedness**
 - **station a Senior Specialist for Nuclear Emergency on each site**
 - **designate a facility “Off-site Center” to be used as the local emergency HQ at each site**
- **Clarify the license holders’ responsibilities**
 - **develop operator’s plan for nuclear emergency preparedness**
 - **establish on-site organization for nuclear emergency preparedness, and designate a manager of the organization**

6

Legal Framework of Emergency Program

BASIC Program for Emergency (*National Government*)

- Basic Law for Emergency Preparedness
- National Basic Program for Emergency

Special Law for Nuclear Emergency (*National Government*)

- Special Law of Emergency Preparedness for Nuclear Disaster

Regulatory Guide (*Nuclear Safety Commission*)

- Emergency Measures for Nuclear Installations

Emergency Plans

- Emergency Plan of National Government (*METI, MEXT*)
- Emergency Plan of Local Governments (*Prefecture, Cities*)
- Emergency Plan of Nuclear Installation Operators

7

Basic System of Emergency Response

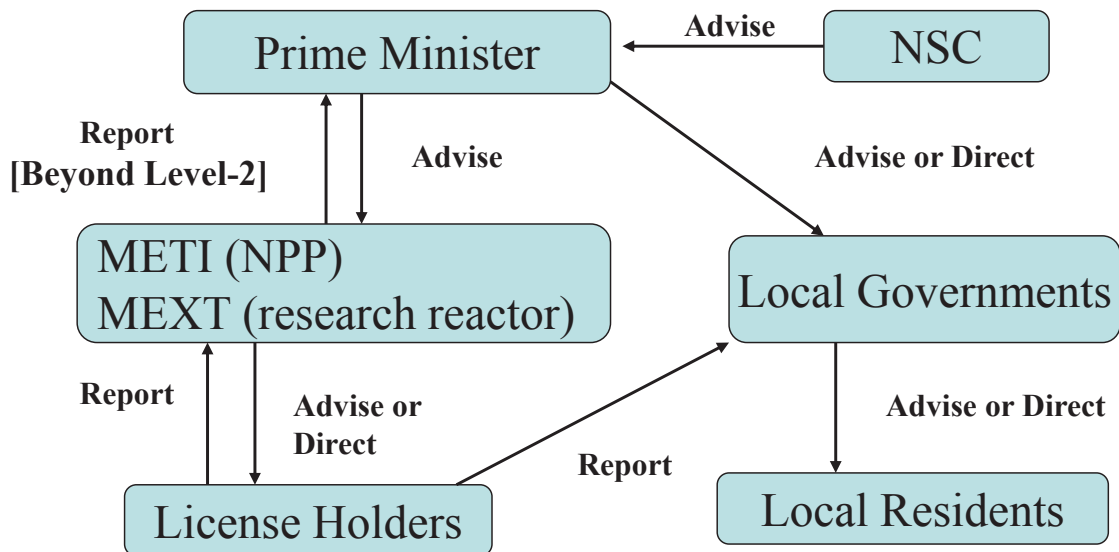

METI :Ministry of Economy,Trade and Industry
MEXT:Ministry of Education, Culture, Sports, Science and Technology
NSC: Nuclear Safety Commission

8

Action Level of Doze for Notification and Emergency

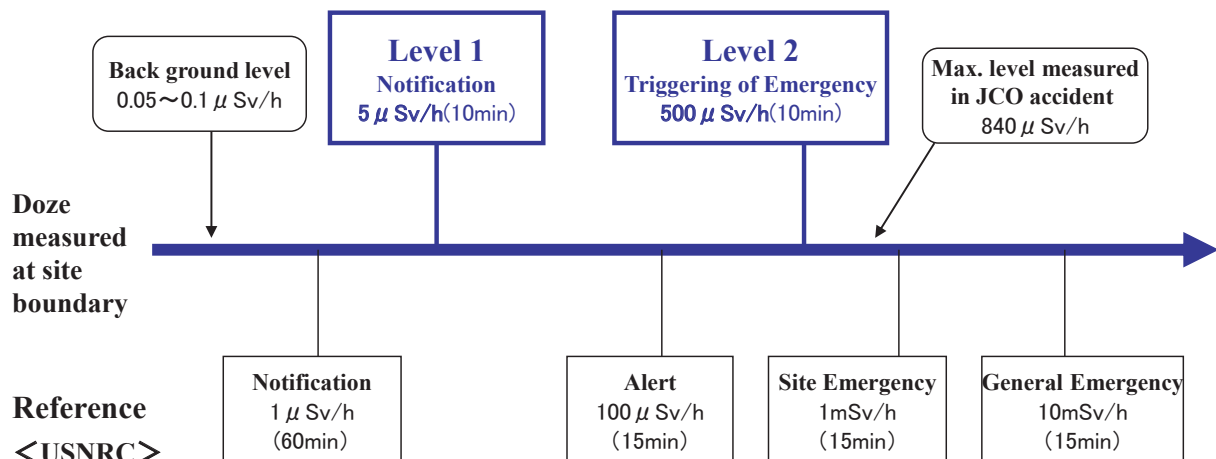

- **Notification** : License holder should notify USNRC and state governments
- **Alert** : License holder should establish Emergency HQ. USNRC and state government will trigger the activity
- **Site Emergency** : Emergency actions, including off-site monitoring and joint activities of NRC and local governments, are started
- **General Emergency** : Emergency countermeasures, including sheltering and evacuation, are started

9

Unusual Events for Notification and Emergency (emergency response for power reactors)

Level 1 Events (*Notification as unusual events*)

- 1) Loss of electric power supply over 5minutes during operation
- 2) Failure of reactor shut-down by control rods when needed
- 3) Loss of core cooling function (LOCA, Loss of feed water, etc.)
- 4) Reduction of spent fuel storage pool water level down to the top of stored fuel assembly

Level 2 Events (*Triggering of emergency actions*)

- 1) Total loss of electric power supply and core cooling capability
- 2) Total loss of reactor shut-down functions when needed
- 3) Total loss of ECCS during LOCA, loss of feed water, etc.
- 4) Total loss of final heat sink of the reactor system
- 5) Detection of core melt
- 6) Over pressure of containment vessel beyond max. design level
- 7) Reduction of spent fuel storage pool water level below the top of stored fuel assembly

10

Action Levels for Sheltering and Evacuation

Project Doses (mSv)		Countermeasures
External Exposure	Internal Exposure	
10 ~ 50	100 ~ 500	Sheltering (In case of neutron exposure, sheltering in concrete buildings, or evacuation)
50 <	500 <	Sheltering in concrete buildings, or evacuation

11

Emergency Planning Zone (EPZ)

- NSC guide proposes a radius around a nuclear facility as an appropriate emergency planning zone (EPZ).
- Local governments are requested to make preparation for urgent contact with the local residents, a system for emergency radiation monitoring, evacuation routes, sheltering places etc, within EPZ in their emergency program.
- The EPZ is determined from the analysis that the public beyond the radius is considered not at significant risk from direct exposure to any radioactive material released.

12

Emergency Planning Zone (EPZ) of Nuclear Installations

Type of Installation		Radius of EPZ
Power reactors and research reactors > 50MW(th)		8 - 10 km
Research reactors < 50MW(th)	Power < 1kW	50m
	10kW < Power < 10kW	100m
	100kW < Power < 10MW	500m
	10MW < Power < 50MW	1500m
	Special design features	Define specifically*
Spent fuel reprocessing plants		5km
Fuel fabrication plants	Liquid, powder or gaseous fuel	500m
	Enrichment > 5%, Pu fuel	
	Others	50m
Radioactive waste storage		50m

* JRR-4 (3.5MW):1000m, HTTR (30MW):200m
 FCA(critical assy.):150m, NCA(MW): 100m

13

Response Structure under the Special Measure of Nuclear Disaster Act

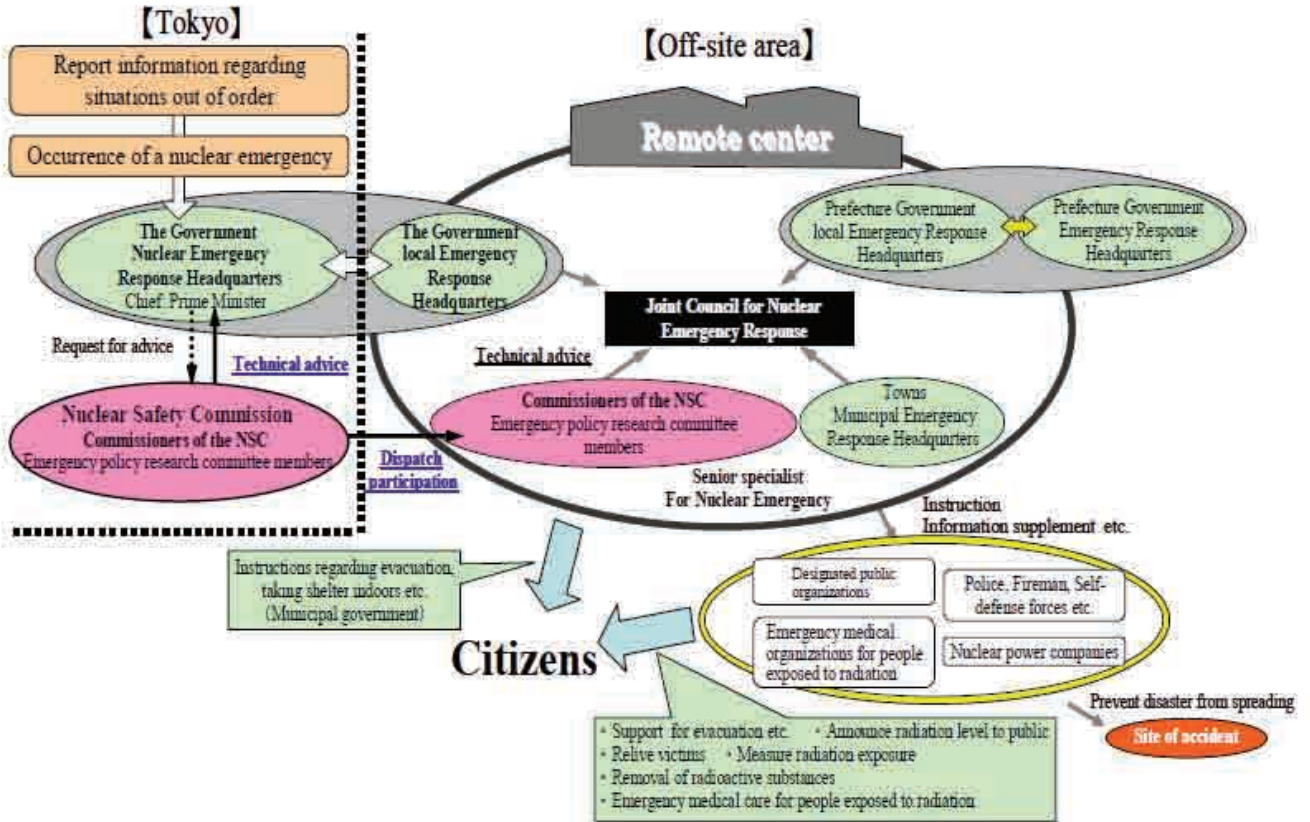

Location of Off-Site Centers

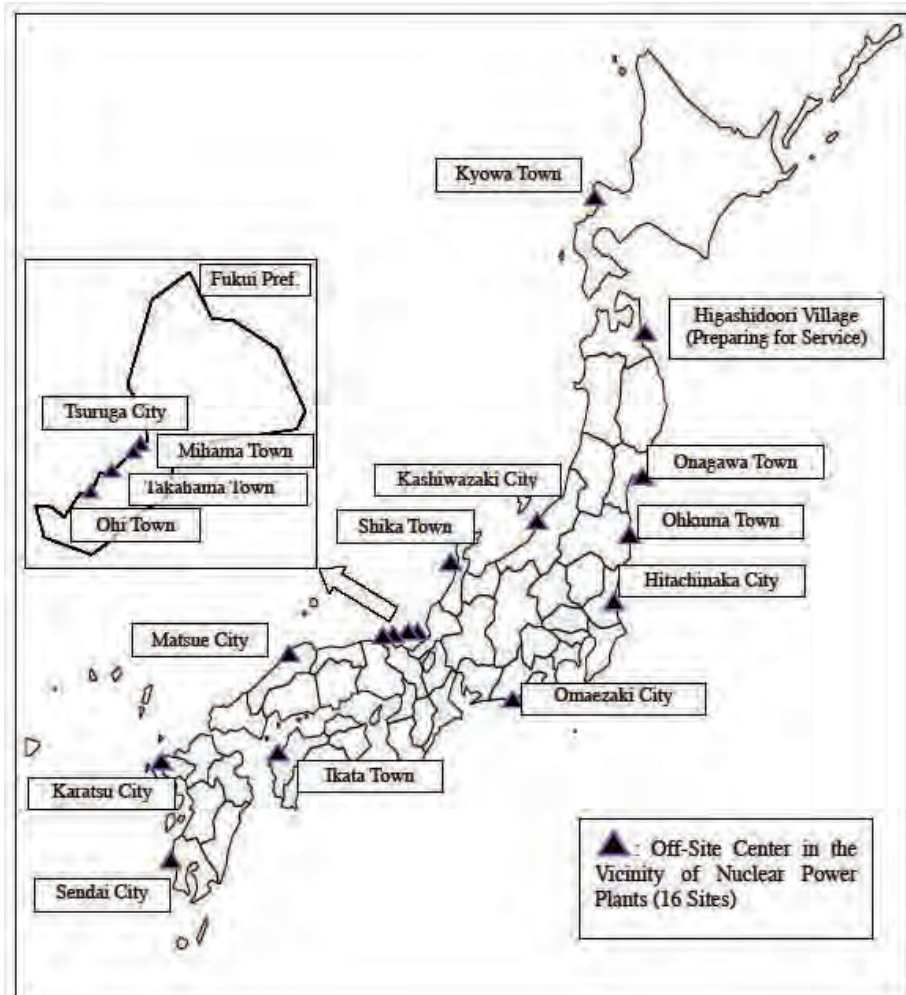

Off-Site Center at Hitachinaka (Ibaraki Pref.)

指定日	平成14年 3月22日
建屋面積	約2,300m ²
対象事業所	日本原子力研究所東海研究所 日本原子力研究所大洗研究所 核燃料サイクル開発機構東海事業所 日本原子力発電東海発電所 日本原子力発電東海第二発電所 三菱原子燃料殿 原子燃料工業東海事業所

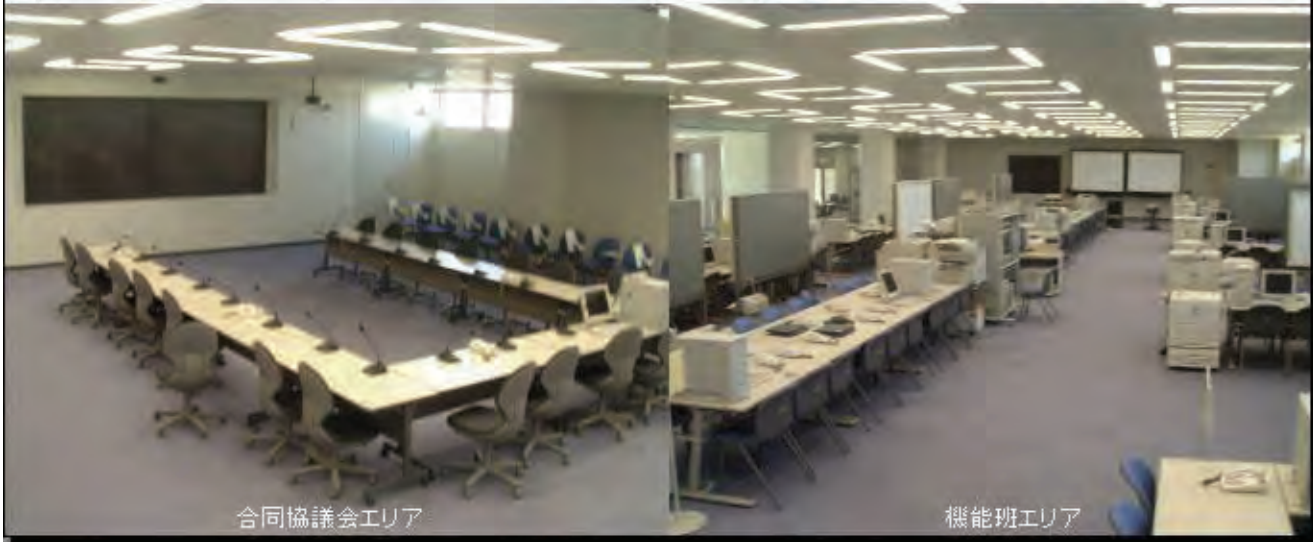

16

Emergency Radiation Monitoring

Monitoring System

- Monitoring Centers of local governments
- Emergency Monitoring Team
- Supporting Team dispatched from JAEA, NIRS and nuclear industry

First Stage Radiation Monitoring

- Start promptly on receiving the report of emergency and make monitoring plan depending on meteorological conditions
- Measure radiation level and density of radioactive materials in the air and environmental samples in the vicinity of nuclear facility
- Assess the doze of residents in the vicinity of nuclear facility for the decision of emergency action

Second Stage Radiation Monitoring

- Detail monitoring by expanding measuring points and kind of radionuclides
- Estimate the actual doze of the local residents
- Assess the general environmental hazard for the decision of long time preventive action

17



Monitoring posts at JAEA Tokai and its vicinity



18

Technical Support System

SPEEDI (System for Prediction of Environmental Emergency Dose Information)

- Perform real-time prediction of environmental and radiological consequences due to large scale accidental discharge
- Indicate current and predicted meteorological conditions
- Provide geological and social information near the NPP site
- operated by the Nuclear Safety Technology Center (NSTC)

ERSS (Emergency Response Support System)

- Provide monitoring data of NPP plant parameters
- Indicate the state of unusual event
- Predict the accident progression by analytical tools
- operated by the Japanese Nuclear Energy Safety Organization (JNES)

19

Example of Predicted Doze given by SPEEDI System

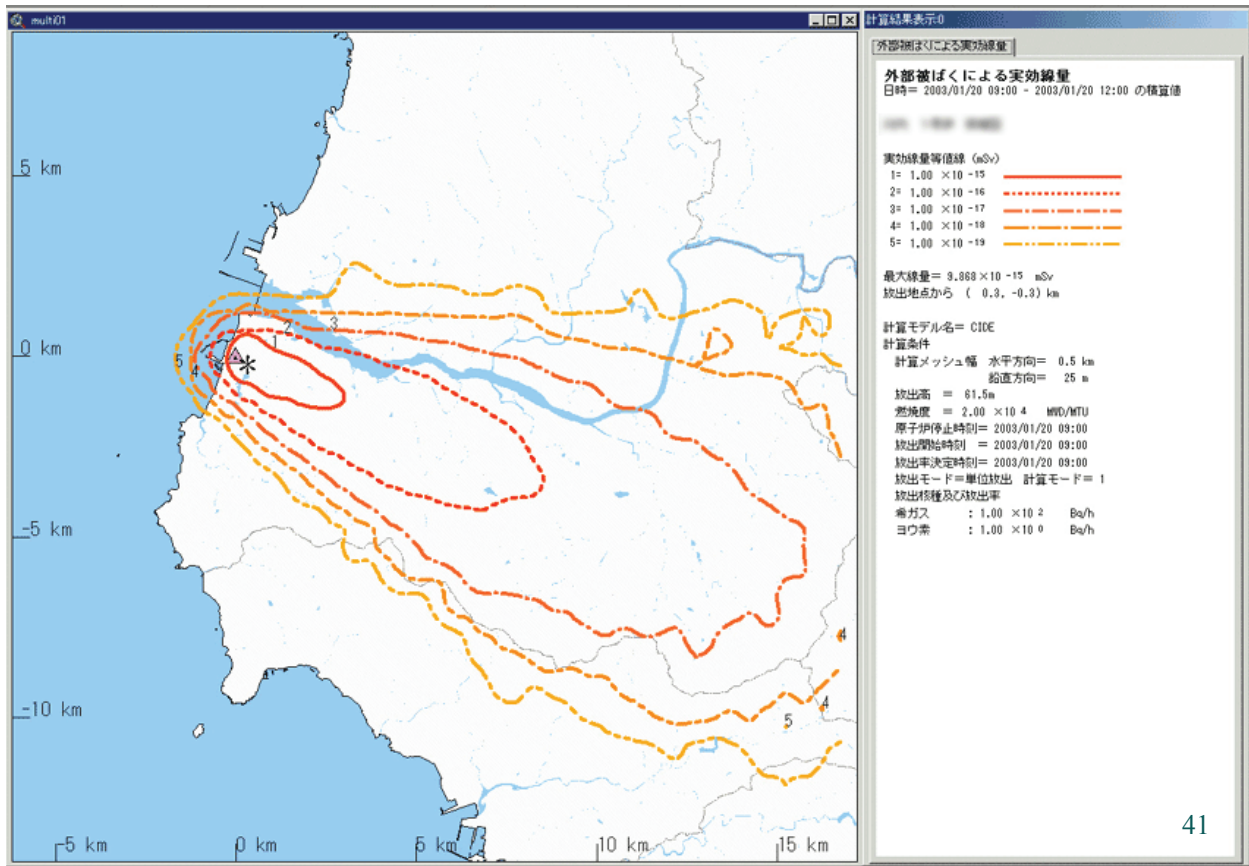

Technical Support Network

Information prepared by SPEEDI and ERSS is delivered through emergency network from the Supporting Centers in Tokyo to Off-site Centers, METI, MEXT, NSC and the emergency centers of local governments.

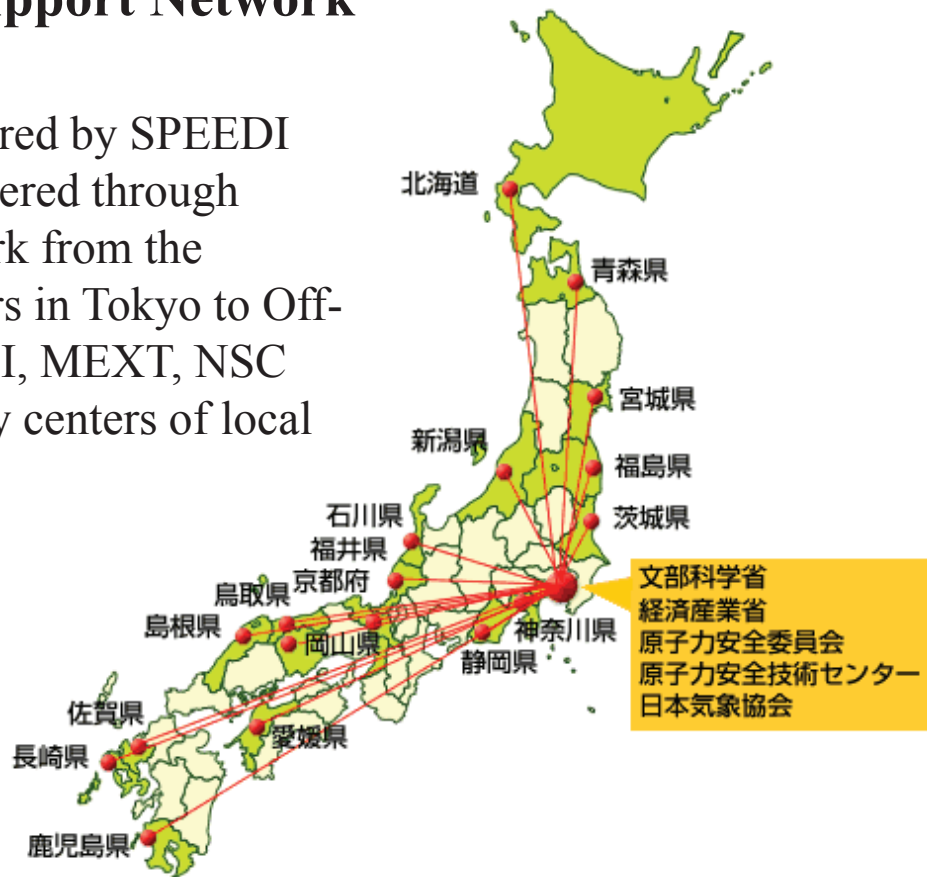

Radiation Emergency Medicine

Objectives

Urgent treatment of workers and local residents exposed in accidents

Basic Procedure

Early Stage Care : at nuclear facility, shelter and local hospitals near the site

- Treatment of exposed patients : Decontamination and first care
- Action for local residents : Surveillance, screening, dose estimation and iodine medication

Secondary Stage Care : at central hospitals near the site

- Treatment of contaminated patients
- Decontamination and dose estimation of high-dose patients

Third Stage Care : at specified governmental and university hospitals

- Special treatment of high-dose patients
- National Institute of Radiological Sciences (NIRS) and some University Hospitals are specified for this care.

22

Nuclear Emergency Drill

- **National Government** : once a year, 9 times since 2001
Comprehensive Nuclear Emergency Drill in collaboration with the national government, local governments, license holders and supporting research organizations, assuming a scenario resulting in core damage
- **Local Government** : once a year for each government
The regional emergency prevention plan prescribes the local drills to be planned and conducted by each local government, which METI and the NSC support by dispatching expert staffs.
- **License Holders** : once a year for each site
On-site drill including establishment of an emergency response headquarter, notification and communication, emergency environmental monitoring, etc.

23

Comprehensive Emergency Drill (2008)

- **Date** : October 21-22, 2008
- **NPP** : Fukushima Daiichi, No.3 Power Station, Tokyo Electric Power Co.
- **Participants** : national government, local governments of Fukushima Prefecture, related cities and towns, Tokyo Electric Power Co., Inc., and organizations relevant to the emergency preparedness.
(96 organizations, about 2,650 persons including local residents)
- **Drill** : Total scope of emergency procedures are conducted including level 1 and 2 notification, declaration of Emergency by Prime Minister, radiation monitoring, direction of measures etc. based on a pre-determined scenario of core destruction accident.
- **Tele-communicatoin** : Tele-conference with TV system between Tokyo headquarters of NSC and METI, and the local headquarters. Does prediction system (SPEEDI) and plant behavior symulation system (ERSS) were connected via internet among the headquarters.

24

Final Stage of Reactor Condition Assumed in Comprehensive Emergency Drill at Fukushima NPP Site (October 21-22, 2008)

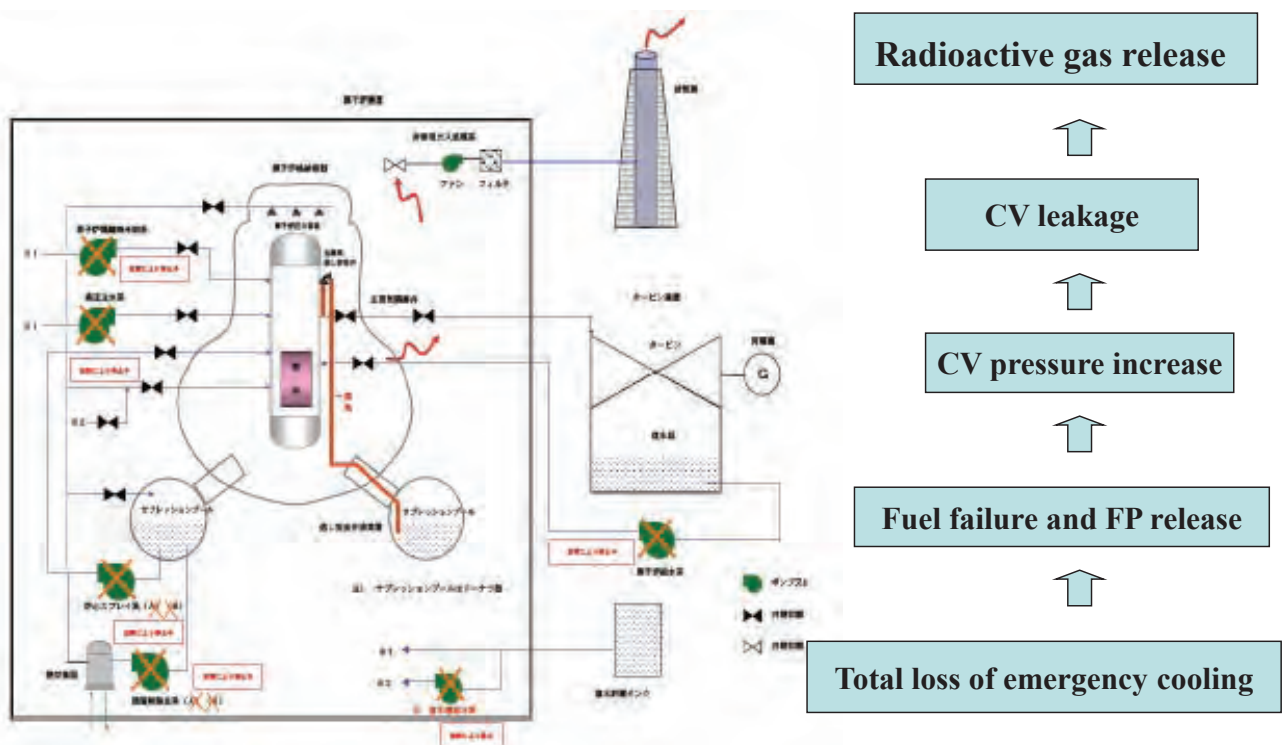

25

Emergency in the Fukushima Accident

Earthquake and Tsunami destroyed the system for nuclear emergency

- Information network was severely damaged by system failure or by loss of electric power supply
- Approach to the local emergency center (OFC) became difficult, major functions of OFC were lost and later evacuation from the facility was requested (OFC had no emergency ventilation system)
- Radiation monitoring system was damaged by Tsunami and by loss of electric power supply
- Many of the emergency staffs were occupied with the activities against natural disaster and not available for nuclear emergency

Core melt and containment vessel leak at 3 NPPs resulted in larger FP release than expected in the emergency program

- Large FP release required evacuation from much wider areas than those assumed in the emergency program
- Wide area contamination by Cs-137 caused serious long term actions

26

Chronological List of Major Actions

March 11

- 14:46 Earthquake, Reactor Shutdown
- 15:42 Notification of **Alert** (Loss of AC Power)
- 16:36 Notification of **Emergency** (Loss of ECCS)
- 19:03 Prime Minister declared Emergency
Establish Emergency Response Headquarters
- 20:50 Local Governor instructed **evacuation of residents within 2km** from the NPP sites
- 21:23 Prime Minister instructed **evacuation within 3km radius, and stay in-house within 10km radius** (loss of cooling at Unit 1)

[Evacuation of about 5,800 people within 3km radius was confirmed by 00:30 March 12]

March 12

- 5:44 Prime Minister instructed **evacuation within 10km radius** (Containment pressure rise)
- 14:40 Start venting of unit 1 CV
- 15:36 Hydrogen explosion at unit 1
- 18:25 Prime Minister instructed **evacuation within 20km radius** (population:78,200)

[Evacuation for 20km area finished by March 16]

March 13

- 5:10 Loss of ECCS at unit 3

March 14

- 11:01 Hydrogen explosion at unit 3

March 15

- 11:00 Local HQ was moved from OFC to Prefectural Office at Fukushima City.
Prime Minister instructed **stay in-house within the area of 20km - 30km radius**.
(population:62,400)

by March 21

- Hospitalized people at “in-house area” (about 700) were transferred to the hospitals out of the area.

March 22

- “in-house area” was reorganized to Deliberate Evacuation Area and Emergency Evacuation-Prepared Area.

27

Outline of Government Headquarters in response to the Fukushima Accident

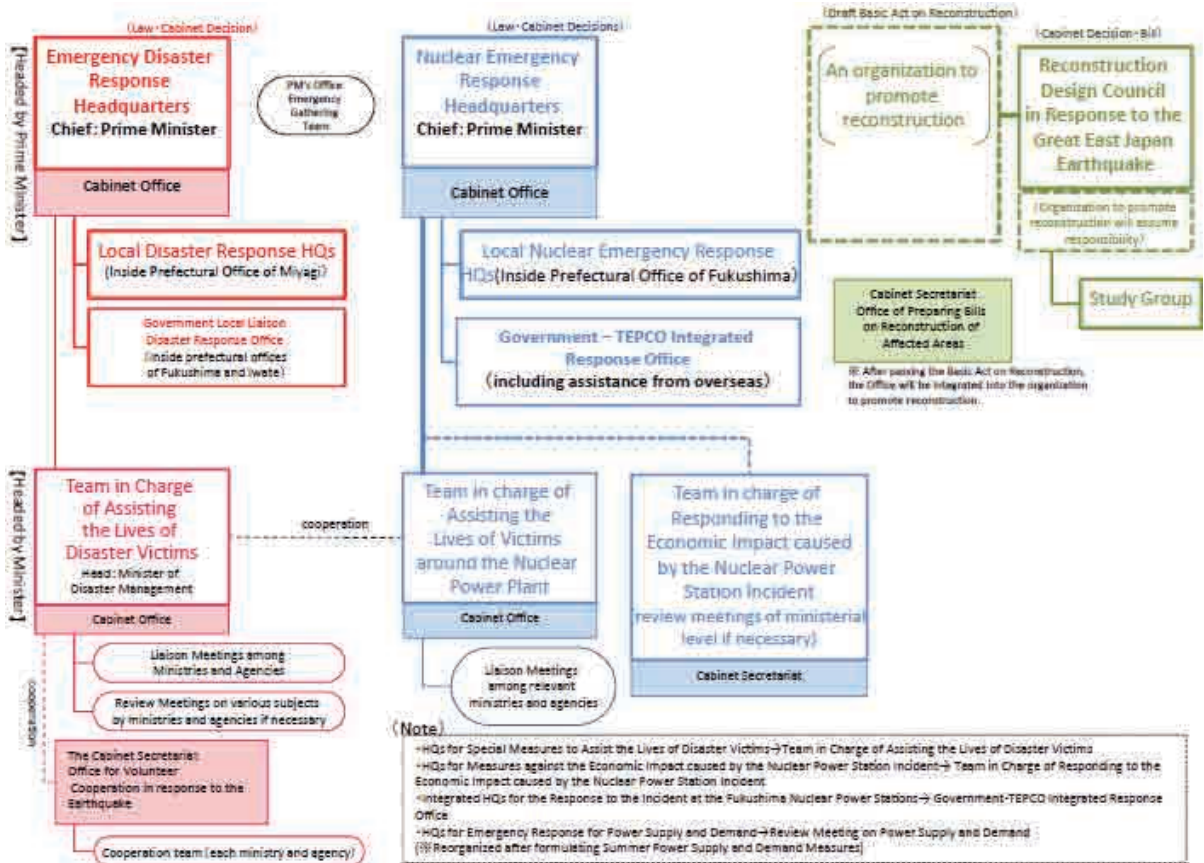

Ref:NISA report at IAEA meeting in April 2011

Measurement of Air Doze On-site and Time of Instruction to Evacuate

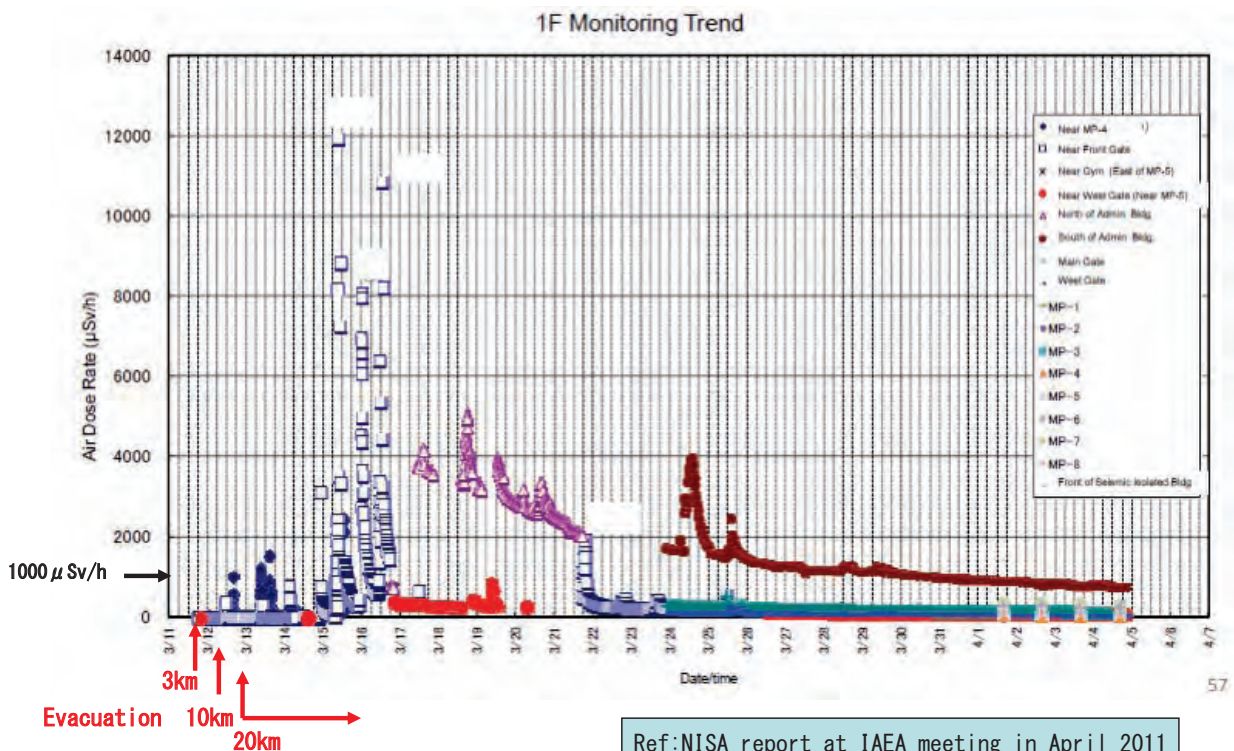

Ref:NISA report at IAEA meeting in April 2011

Estimation of Internal Exposure by SPEEDI

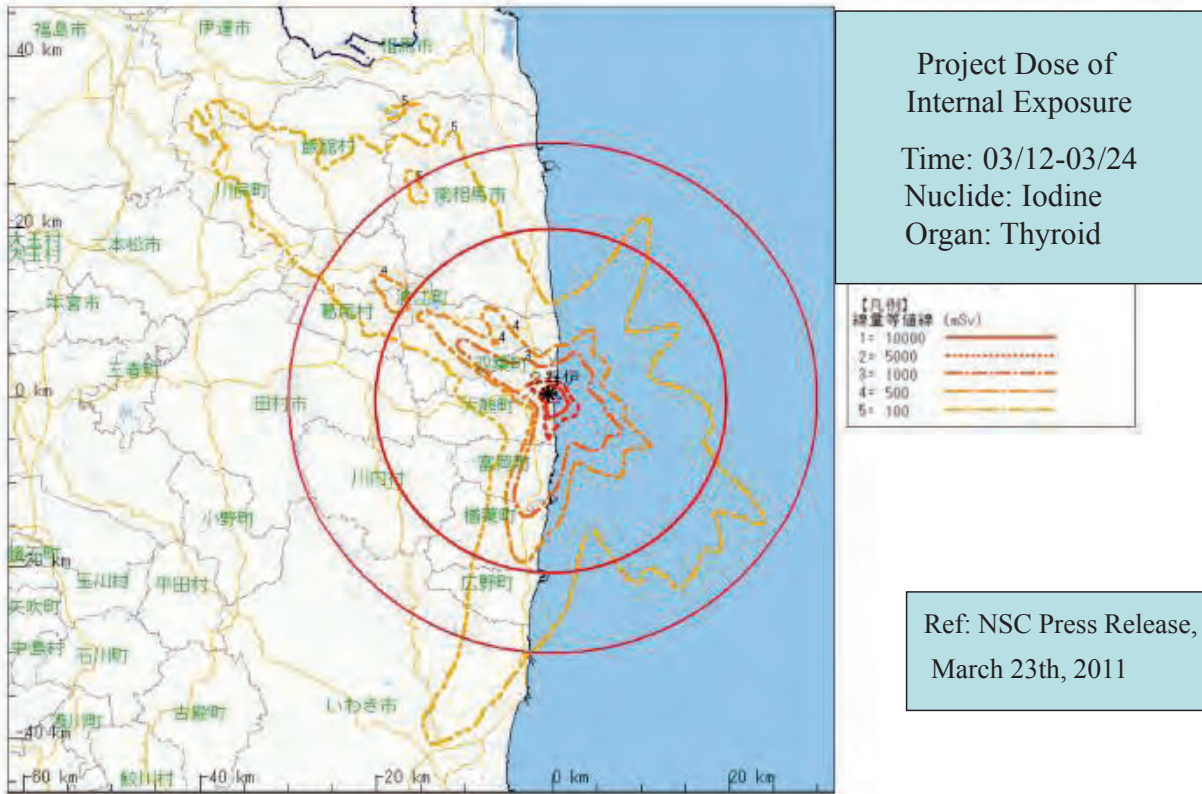

30

Map of Evacuation Areas after Reorganization in March 23, 2011

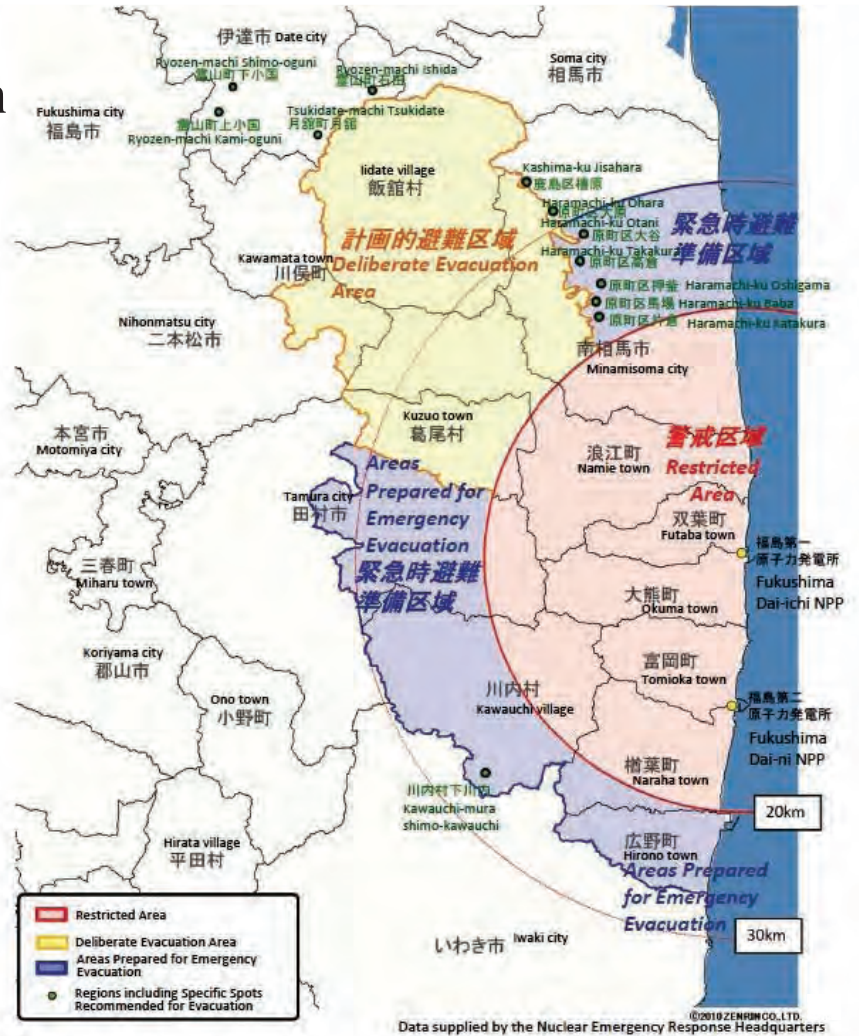

Ref: Interim Report of National Committee for Study and Investigation of the Fukushima Nuclear Plant Accident, December 2011

Emergency Action Taken

Monitoring

- Most of monitoring posts were damaged, and measurement was conducted by monitoring cars and portable instruments. Due to damaged road condition by earthquake, monitoring was quite limited.
- As the second stage, wide area monitoring was performed by monitoring cars and airplane, and by measurement of soil and other samples.

Decision of emergency action

- Due to the damage of off-site center function and information network, major communication was performed between Fukushima Daiichi NPP on-site emergency center and TEPCO Tokyo office. Government-TEPCO Integrated Emergency Office was temporary established and functioned as an emergency operation center.
- Emergency technical support systems, SPEEDI and ERSS, were not effectively utilized due mainly to the loss of information network.
- Decision was done based on accident conditions: evacuation of 3km by loss of core cooling, 10km by CV pressure increase, 20km by hydrogen explosion.

32

Emergency Action Taken (cont'd)

Evacuation

- Damage of information network and other difficult conditions prevented smooth transfer of instruction to the city offices via local government. In many cases, action was initiated by the decision of city mayors based on TV information.
- Due to the expansion of evacuation area, sheltering places had to be changed after the initial evacuation action.
- Early start of evacuation prevented high-dose exposure or contamination.

Iodine medication

- Tablets of stable iodine were prepared at prefecture and city offices.
- Clear instruction was not provided by the emergency center, and distribution was dependent on the decision of city offices.

Radiation emergency medicine

- A few contaminated TEPCO workers and several inhabitants of contaminated area were sent to NIRS and examined.
- Screening of people moved from evacuation areas was performed.

33

Long Term Actions needed

Environmental monitoring

- Detailed monitoring of near site and wide area contamination: land and sea
- Monitoring of agricultural food and drinking water

Aftercare of inhabitants

- Support of living and health care for the people evacuated from the contaminated area
- Support of migration from or returning to the home town
- Medical follow-up

Information provision

- Public information through TV and other information medias
- Provide detailed information through internet

Decontamination

- Decontamination of areas for resumption of farming and other activities
- Decontamination of affected areas to decrease population dose

Mitigation of non-radiological consequences

34

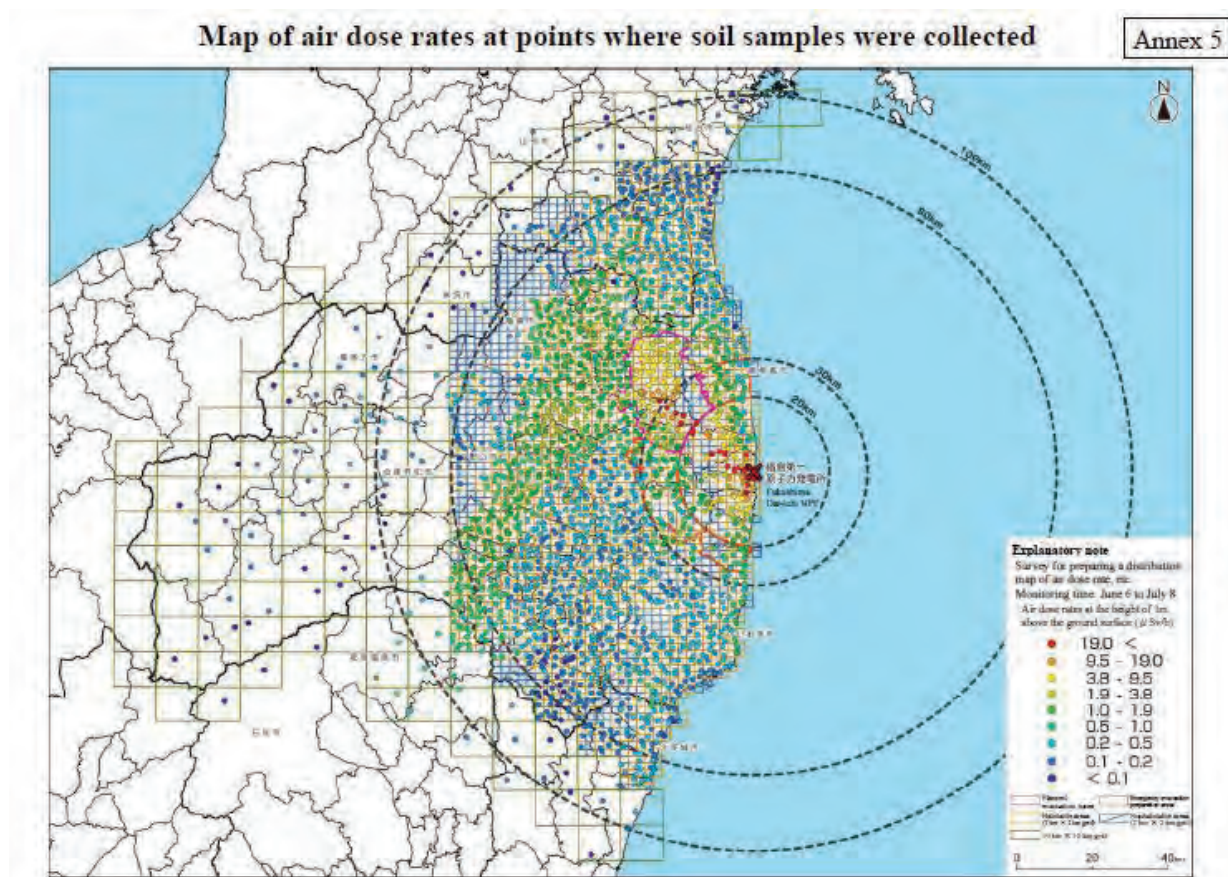

35

Lessons Learned from the Accident

- **Release of radioactive material in the accident was much larger than expected in the emergency program. Emergency plan should be prepared to higher hazard.**
- **Attack of huge earthquake and loss of electric power supply destroyed the function of the prepared emergency systems, including off-site center, radiation monitoring system and information networks. Robust system is needed against duplication of natural and nuclear hazard**
- **Long term action became very important due to large release of long life FPs (mainly Cs-134, 137). Studies of long term issues including decontamination are needed.**
- **Non-radiological effects (mental and social influences) were not prevented and long term care should be needed.**

36

Steps for Better Emergency Preparedness

- **Revise NSC guide for emergency planning and strengthen national and local emergency program**
 - Expand planning zone : from 10km to 30km
 - Apply IAEA guides : introduce PAZ and UPZ
- **Strengthen radiation monitoring and other supporting systems for emergency action**
 - establish robust radiation monitoring system, diversified information network, multiple evacuation rout
 - establish robust off-site center and its substitute facilities
- **Modify framework for emergency action**
 - Refurbishment of government system for nuclear emergency are planned in the reorganization of national regulation framework.

37

Summary

- **Development of emergency preparedness for nuclear accident started by the impact of the TMI-2 accident and enhanced by the Chernobyl accident.**
- **The program was highly strengthened by the impact of JCO accident in which first emergency response was activated in Japan, and special law for nuclear emergency was established just after the accident.**
- **Emergency centers (Off-site centers), preparation were constructed near every NPP site, and emergency drills have been conducted frequently.**

38

Summary (cont'd)

- **In Fukushima NPP accident, huge earthquake and resulting large FP release caused many difficult situation in emergency actions, but radiological effects to the public were effectively prevented by early start of evacuation before FP release.**
- **The experience of the Fukushima NPP accident also gave us many lessons in emergency planning, and action has started for better emergency preparedness.**
- **Long term actions both for radiological and non-radiological influences caused by the wide area contamination of the environment are the next big issues to be solved.**

39

References

- 1) Special Law of Emergency Preparedness for Nuclear Disaster, December 1999**
- 2) NSC Safety Guide, Emergency Measures for Nuclear Installations, May, 2007**
- 3) Report of the Japanese Government to the IAEA Ministerial Conference on Nuclear Safety, June 2011**
- 4) NISA report at the side event on the “Fukushima Daiichi Accident and Initial Safety Measures Worldwide” in IAEA, April 4th, 2011**
- 5) Interim Report of National Committee for Study and Investigation of the Fukushima Nuclear Plant Accident, December 2011**

Workshop on “One year after Fukushima: rethinking the future”
Italian National School for Public Administration
Via Testoni n. 2 – Bologna Italy
15-16 March 2012

IRSN

INSTITUT
DE RADIOPROTECTION
ET DE SÛRETÉ NUCLÉAIRE

Faire avancer la sûreté nucléaire

Fukushima Dai-Ichi’s

Radioactive Source Term and Release



O. Isnard, E. Raimond, D. Corbin

and J. Denis

Presented by G.B. Bruna

Historical background

- An earthquake of magnitude 9 - and a subsequent massive tsunami - hit the eastern Japan coasts on March 11 2011.
- The Fukushima Dai-Ichi Nuclear Power Plant was severely affected and caused a radiological emergency.
- The generalized station blackout engendered severe damage in some reactor units and massive atmospheric releases since March 12.
- The situation was immediately brought at an international level, and the IRSN's Emergency Technical Centre - *CTC* - was activated within a few hours.

Historical background

- The IRSN's *CTC* strictly applied to the Fukushima Dai-Ichi case the methodology settled for nuclear emergency in France.
- The *installation assessment team* collected all available technical information to appreciate the situation of the units and to forecast the likely evolution of the situation.
- The assessment of the radioactive releases to the atmosphere was thus undertaken.
- So that the *radiological consequences assessment team* was able to start estimating the atmospheric dispersion, the ground deposition and the radiological consequences at different scales (local, regional and worldwide).

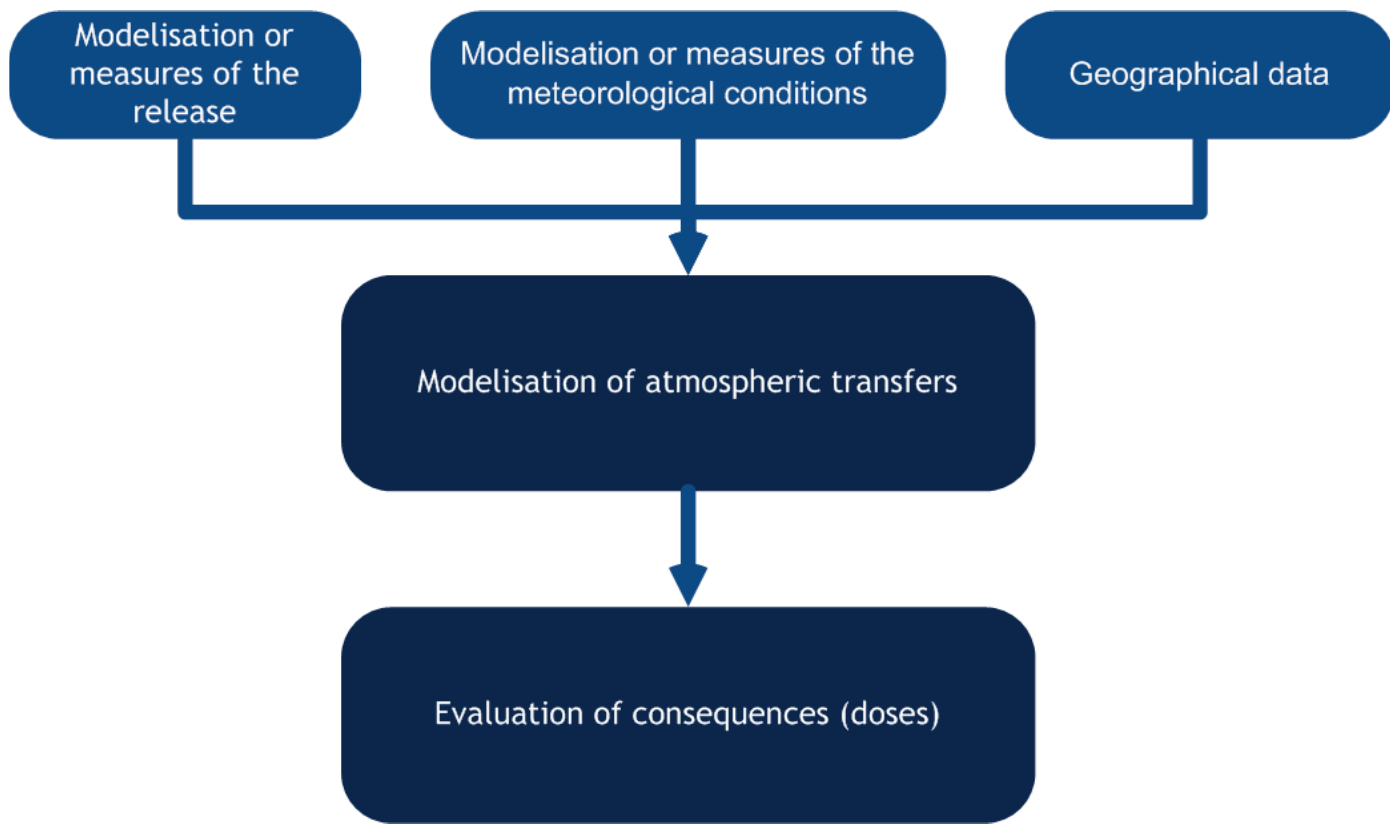

Reactors (and pools) assesment

- The expertise on each reactor and spent fuel pools was relying on parameters provided by TEPCO
- Improvements of the methodology were necessary to assess the reactor state, forecast the current situation and evaluate the releases

DIAGNOSTIC/PRONOSTIC - FUKUSHIMA1 - 19/03/2011 - 22h00
ETAT DES PISCINES¹

	Piscine 1	Piscine 2	Piscine 3	Piscine 4	Piscine 5	Piscine 6	Piscine commune
Nombre d'assemblages en piscine	292 usés 100 neutrs	587 usés 28 neutrs	514 usés 52 neutrs	703 usés 204 neutrs 548 irradiés	946 usés 48 neutrs	876 usés 64 neutrs	6375
Puissance réelle	0,51 MAJ (estimation IRSN)	0,93 MAJ (estimation IRSN)	0,83 MAJ (estimation IRSN)	3,73 MAJ (estimation IRSN)	2,35 MAJ (estimation IRSN)	1,21 MAJ (estimation IRSN)	Estimation IRSN à atténuer : 1,5 MAJ
Refroidissement	Non	Non Une ébullition est en cours.	Non Une ébullition a eu lieu jusqu'au 18 mars. Deux appoints réalisés appoint en continu envisagé.	Non Une ébullition a eu lieu jusqu'au 18 mars. Un appoint réalisé	Température : 19/03/11 à 11:00 : 66,6°C A 18:00 : 40,1°C, (comme TEPCO a précisé) Injection d'eau via le système d'appoint (alimenté par diesel)	Température 66,5°C (19/03/11 à 11:00) 55°C le 18 à 11:01 (H.Jap) (NISA n°30) Injection d'eau via le système d'appoint (alimenté par diesel)	REFROIDISSEMENT NON CONFIRME Niveau nominal (10/03 à 08:00) 55°C le 18 à 11:01 (H.Jap) (NISA n°30)
Pronostic : Délai de découverte à partir du 19/03	Supérieur à 1 mois sans fuite	Supérieur à 20 jours	Supérieur à 1 jour Un appoint rapide est absolument nécessaire lors de chaque ébullition	Supérieur à 10 jours			Avant le début du refroidissement : > 1 mois

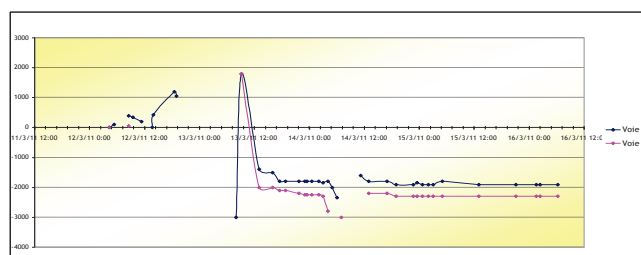
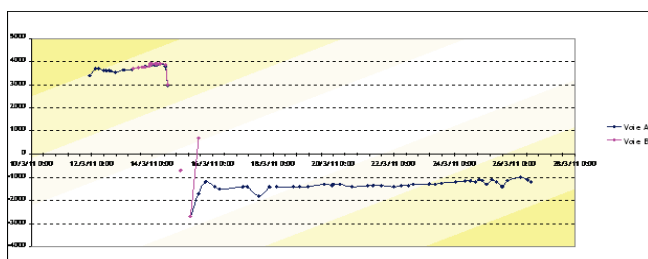

Assumptions

Unit 1, 2 and 3 were represented as a single damaged unit with:

- The total radionuclide core inventory inside,
- A 45 % core melting - correspond to the average of the individual estimation of each individual unit -
- A continuous leakage from the containment (0,5 % vol/day),
- 12 periods of major release (30 minutes) with a flow rate equal to 230 %Vol/day - the precise time of each-one being estimated from the dose rate peaks measured on site stations located in the vicinity of the reactors -;
- A containment failure with a 60 %Vol/day flow rate.
- A retention factor (equal to 10) for the aerosol in the suppression pool (it was assumed that the suppression pool was not bypassed during the venting phases)

Methodology

- Preliminary identification of the radioactive release periods for each Unit 1, 2 and 3, to evaluate a set of release peaks (temporal aspect) relying on the information available from the Fukushima Dai-Ichi site.
- Identification of the radioactive release periods for each unit.
- Improvement of the release amplitude and composition estimation, based on dose monitoring.

Methodology

- Releases of “marked tracers” of Cs137 every 3 hours, constant rate: 10^{12} Bq
- The radioactive decay of Cs137 was taken into account, but not the filiation (Ba137)
- Deposition was activated
- Tracers were simulated with a regional dispersion model with meteorological data from ECMWF at 0.125° resolution

Dose rate stations over Japan and model grid mesh.

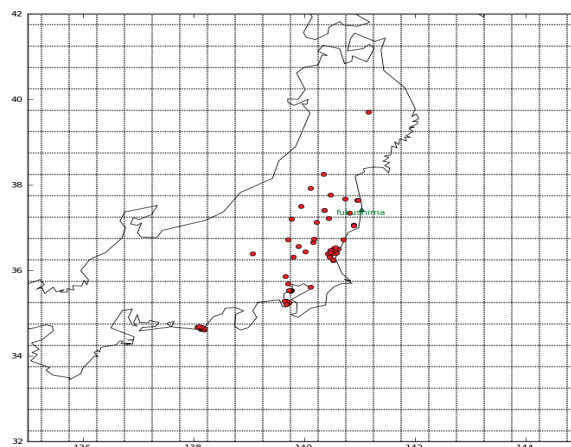

Methodology

- Measured dose rate was compared to the activity of the tracer.

If a tracer coincided with a peak, a “yes” was attributed. If the tracer concentration was non-negligible while there was no variation in dose rate, a « no » is attributed.

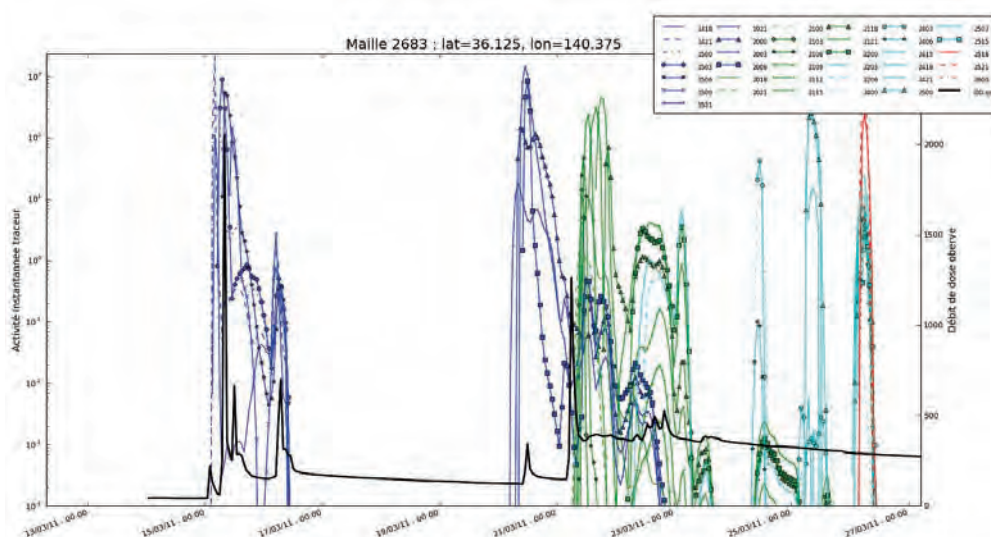

Before march, 25th, every peak seen at the stations over Japan could be explained by dispersion only => continuous release plausible

Methodology

Release periods predicted by the model :

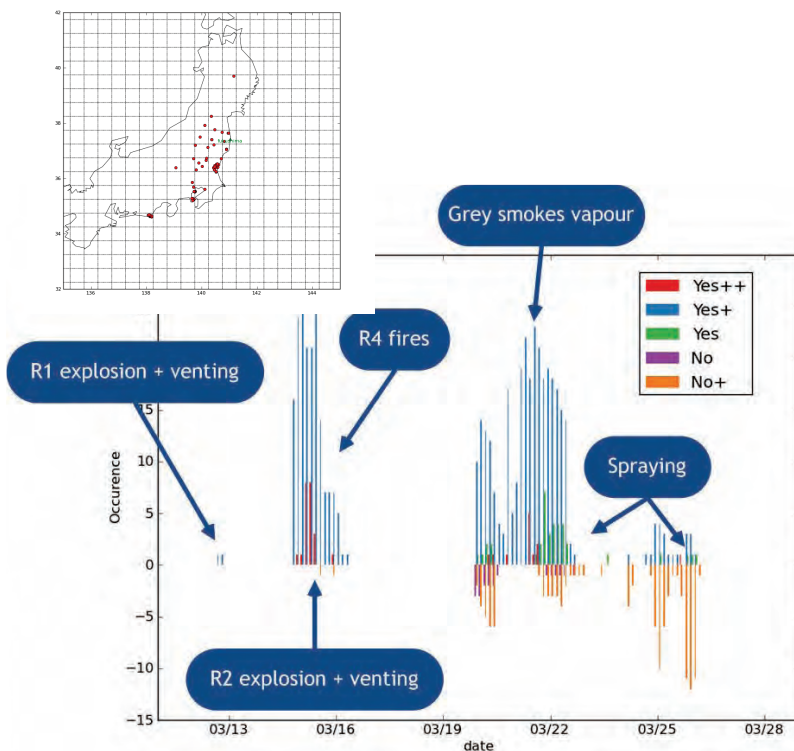

A « yes »-tracer does not necessarily mean a release period.

Model uncertainties (meteorology, dispersion) lead to:

Uncertainty on the time of arrival of each tracer ~ 6 hours

Uncertainty on the localization of the plume

The tracers could be shifted by 6 hours

« yes » or « no » could be due to plume errors

Phenomenology

- The explosion of Unit 1, quickly identified as a hydrogen explosion, testified that the core had already started melting.
- In terms of release, it was obvious that part of the gaseous radioactive elements (noble gas, iodine ...) had already spread out.
- The explosions in Unit 2 & 3 buildings definitely demonstrated how predictable is the sequence of events for these plants in case of long-term station black-out

Phenomenology

- The core melt of unit 1 started at 17h00 on March 11, the hydrogen explosion occurred at 15h36 on March 12.
- The early atmospheric releases were transported towards north and then towards the ocean.
- Most of the meteorological stations and the dose rate measurement stations were out of use during this period.
- The only station which was able to detect the radioactive plume from unit 1, was the one located in Minami Soma some 25 kilometres north from the nuclear site on the shore.

IRSN

Noble Gas (Bq)	4.5 e+18
Iodine 131 (Bq)	1.1 e+17
Cesium 137 (Bq)	1.1 e+16

NISA - JNES

Noble Gas (Bq)	-
Iodine 131 (Bq)	1.3 - 1.6 e+17
Cesium 137 (Bq)	0.6 - 1.5 e+16

Iodine release rate

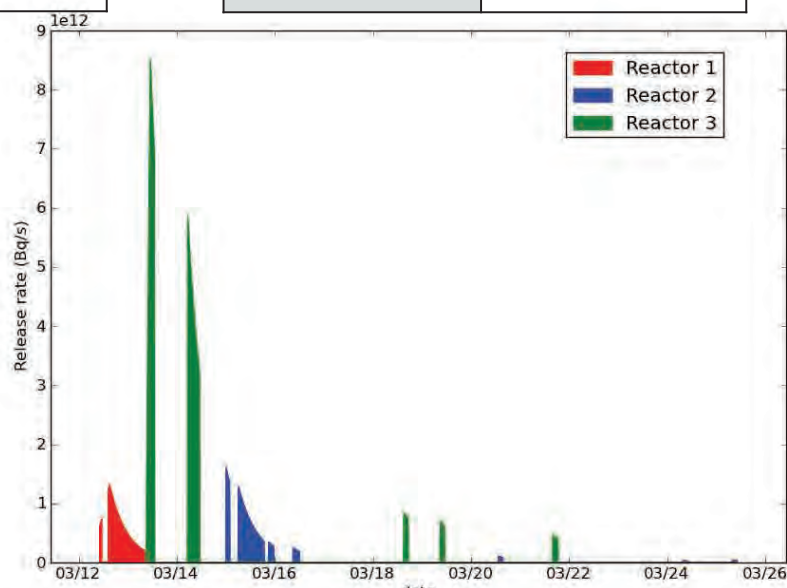

Assessment consistent among the different Organizations

Support from Météo France

- World scale: ARPEGE model @ 0.5° resolution
- Country wide: ECMWF model @ 0.125° resolution
- Small scale: AROME model @ 2.5 km resolution

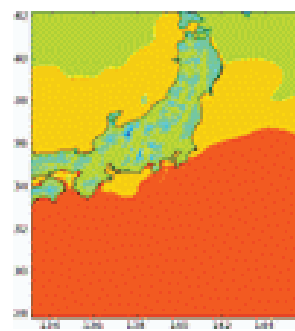
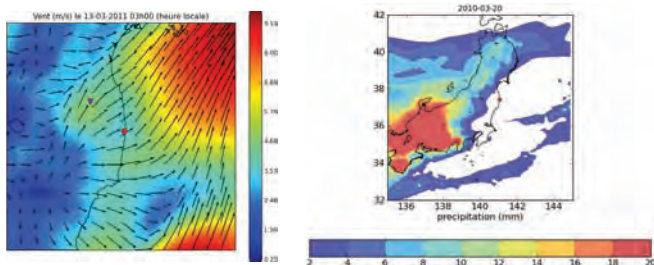
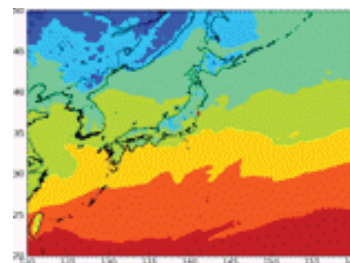
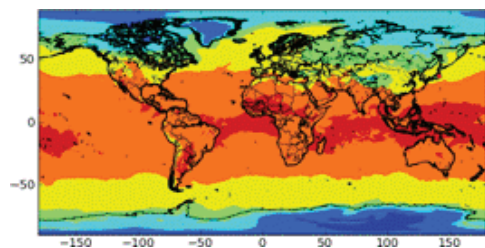

Event #1, reactor 1 explosion (March 12, 15h36 JST)

- The gamma dose rate stations were all down except for Minami Soma's (in the North)
- The duration and composition of the release was hard to evaluate
- The computed plume dose rate was mainly due to Iodine (I-132)

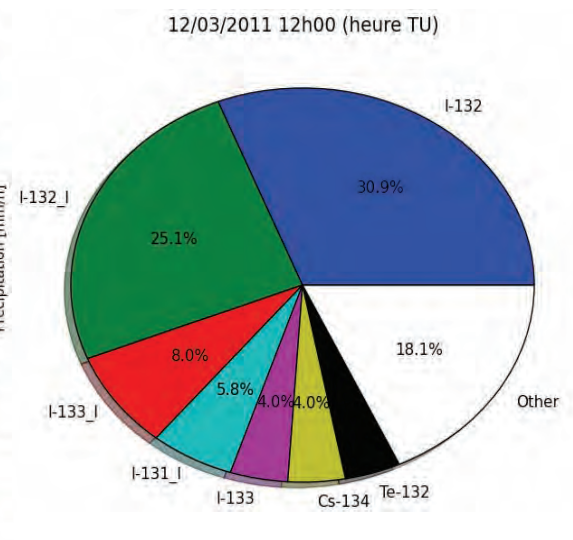
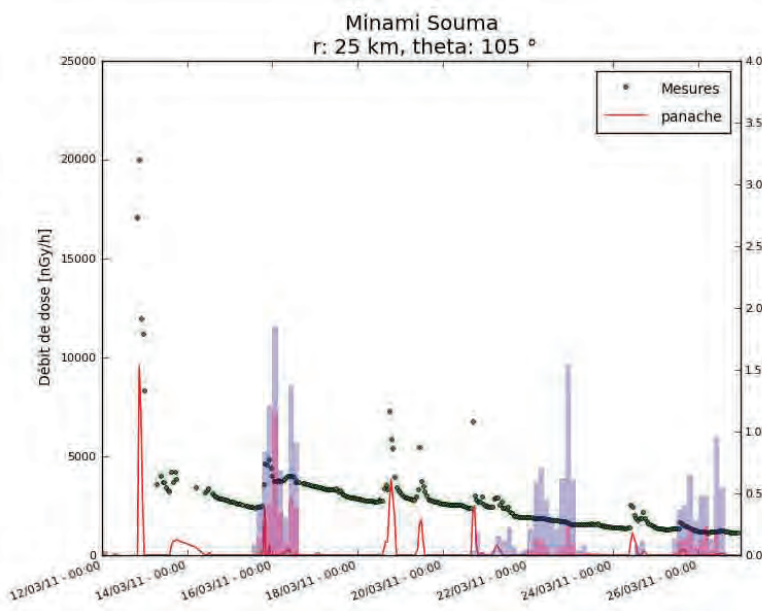

Event #1, reactor 1 explosion (March 12, 15h36 JST)

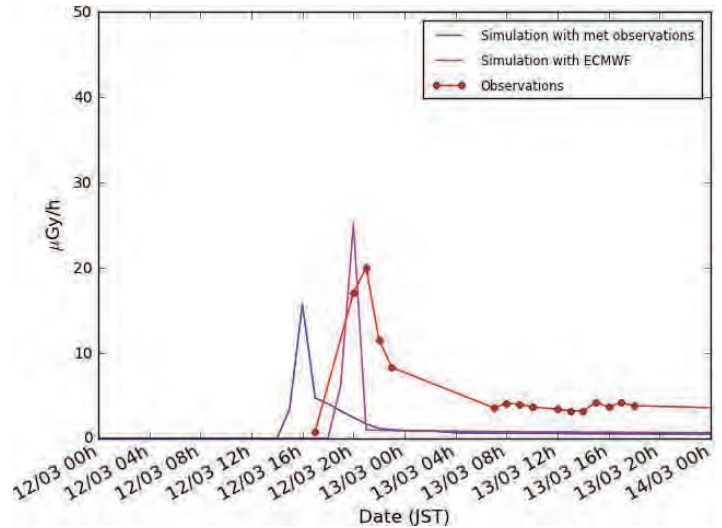
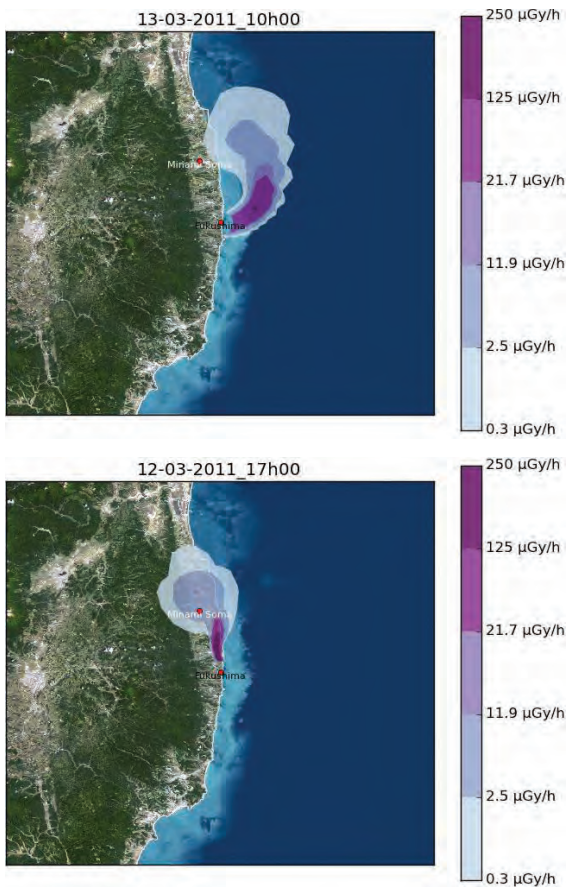

Event #2, meltdown of reactor 2 (March 15, 0h02 JST)

- Progression of a rain-snow front between 3/15 & 3/16 towards the nuclear site
- At the same time, explosion of R2 and radioactive releases occurred

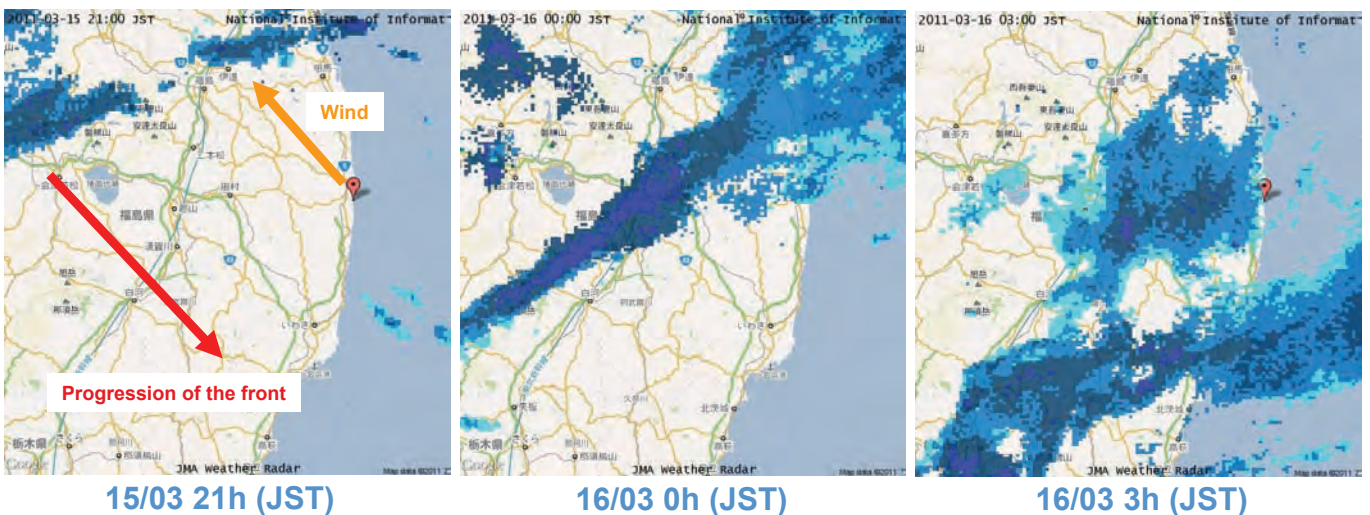

Wind direction for March 15

Rather good agreement for ECMWF @ Iitate, Some discrepancies @ Daiichi...

MSM (Japanese model)

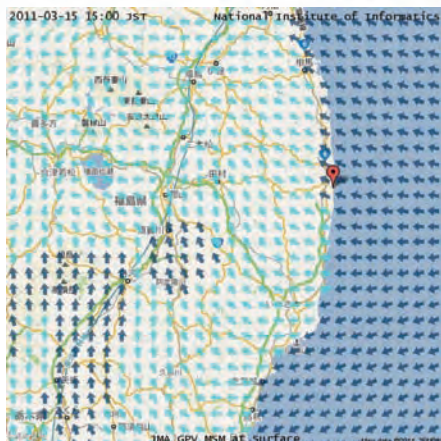
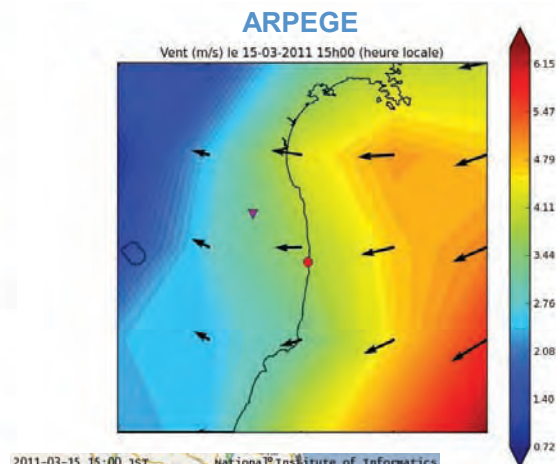
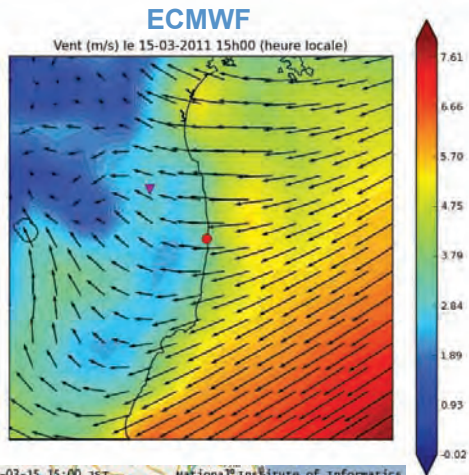

Observations

Good agreement between model and measurements @ Japan scale

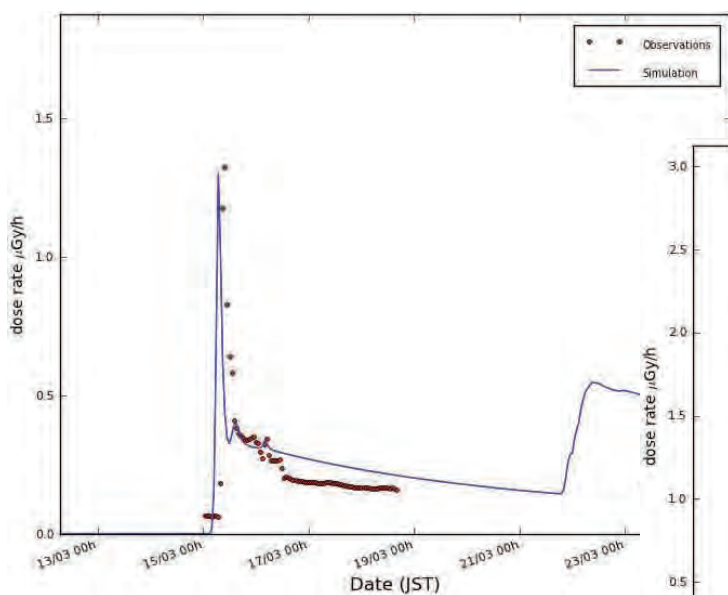

Ibaraki

Aizuwakamatsu

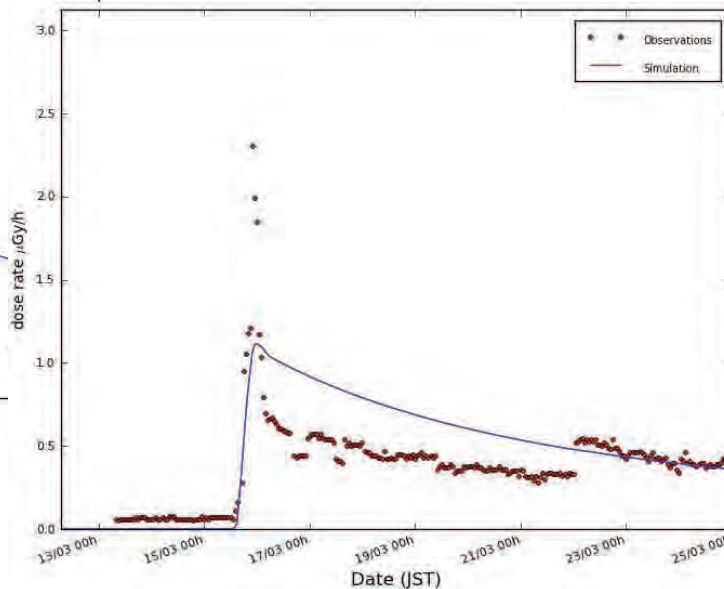

Contamination on the ground was due to wet scavenging during a very short rainfall event ($\Lambda = 5.e-5 \text{ h/mm/s}$) between 21h 3/15 and 06h 3/16.

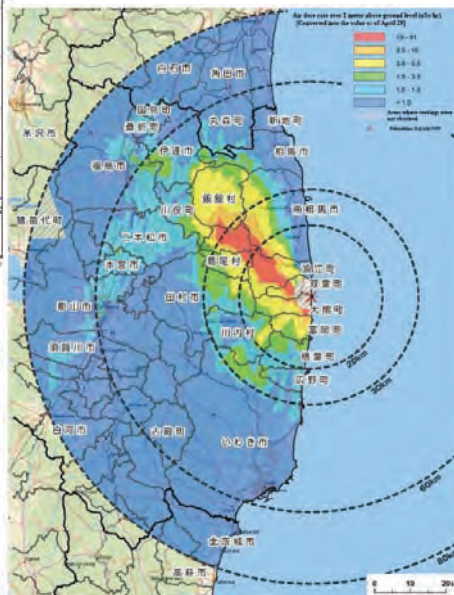
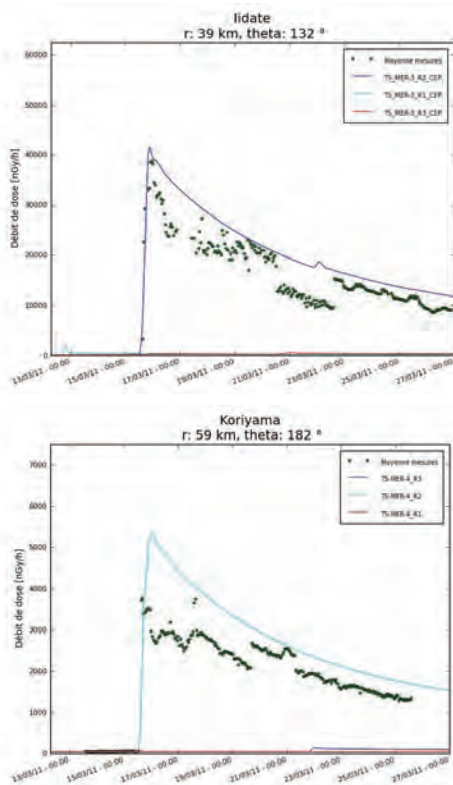

Rain radar measurements

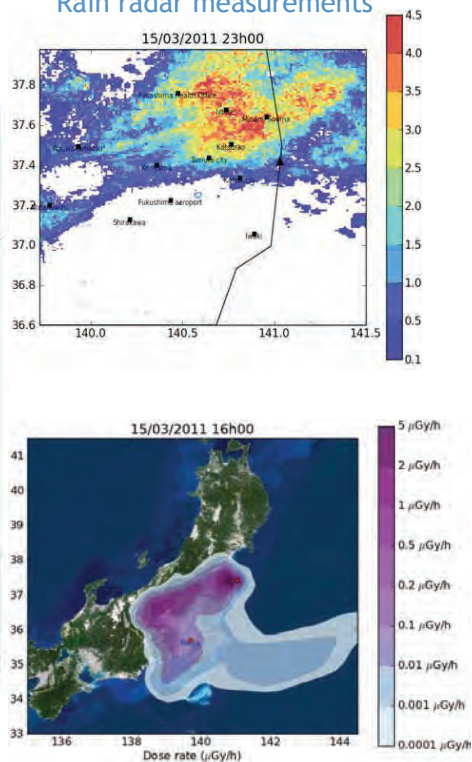

Event #3, venting, explosion & meltdown of reactor 3 (March 13, 8h JST)

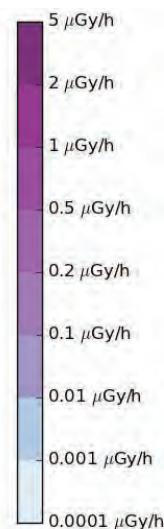
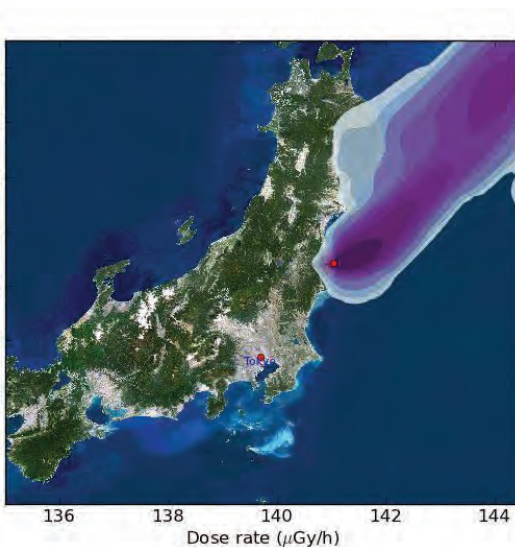
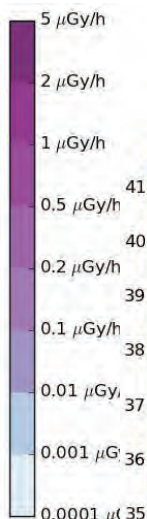
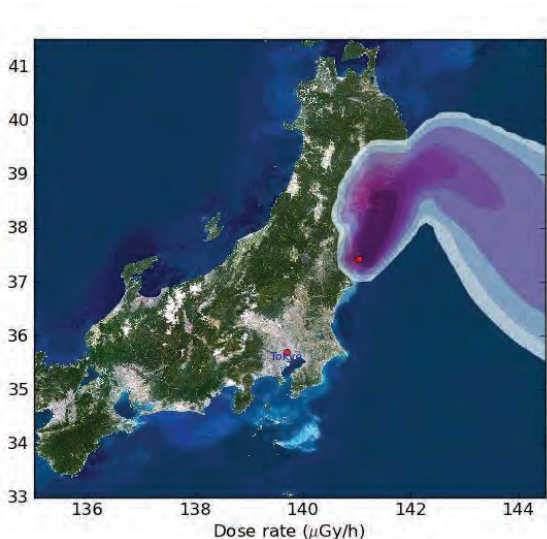

No detection with observations (Canada -US) :

- Contamination was dispersed toward the sea
- Still a lot of dose rate stations were down at that time)

Huge uncertainties on the release

From US-DOE/NNSA (AMS) measures

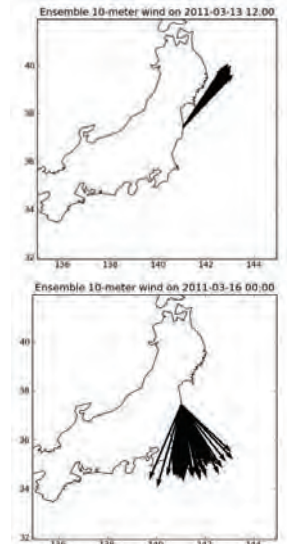
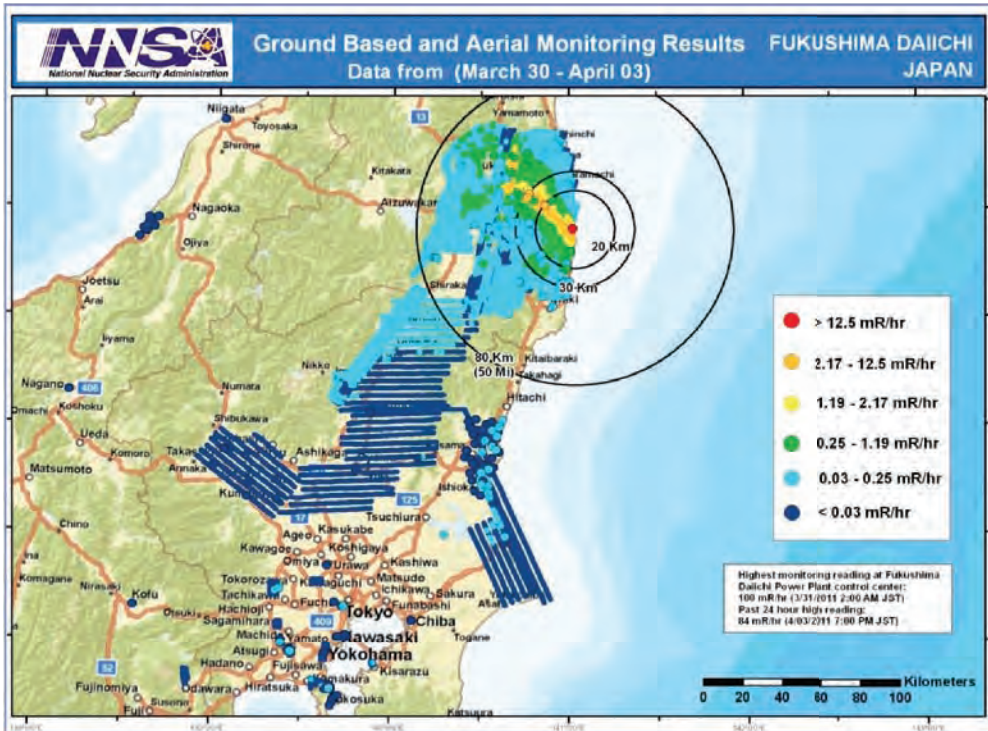

Ensemble forecast, ECWMF

Contamination of Japan land made during a very short episode with a very difficult meteorological situation to forecast and to re-analyze

Atmospheric dispersion at small scale

Dose rate from R2 only, using observed wind and radar rain

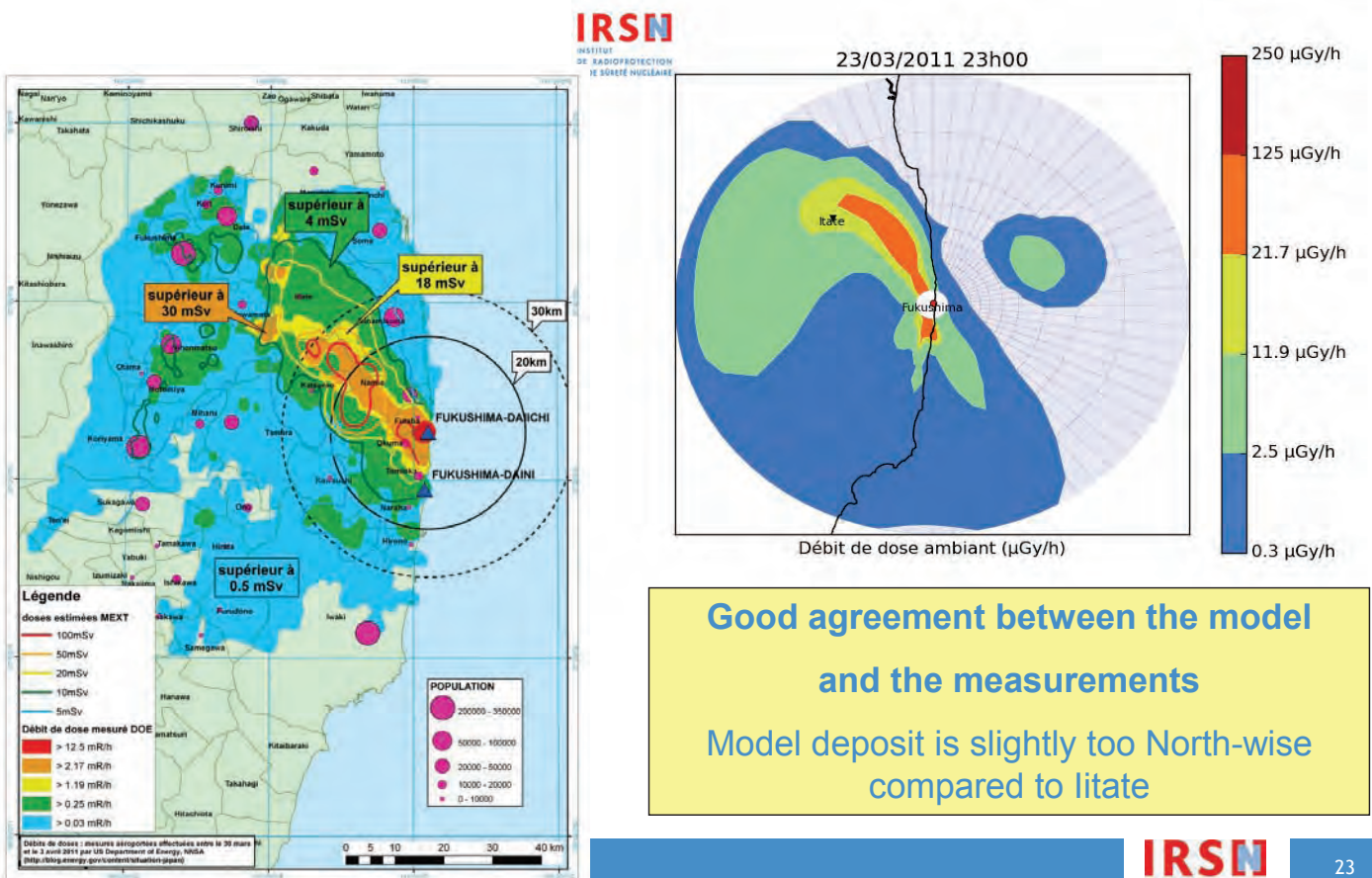

North station: Minamisoma

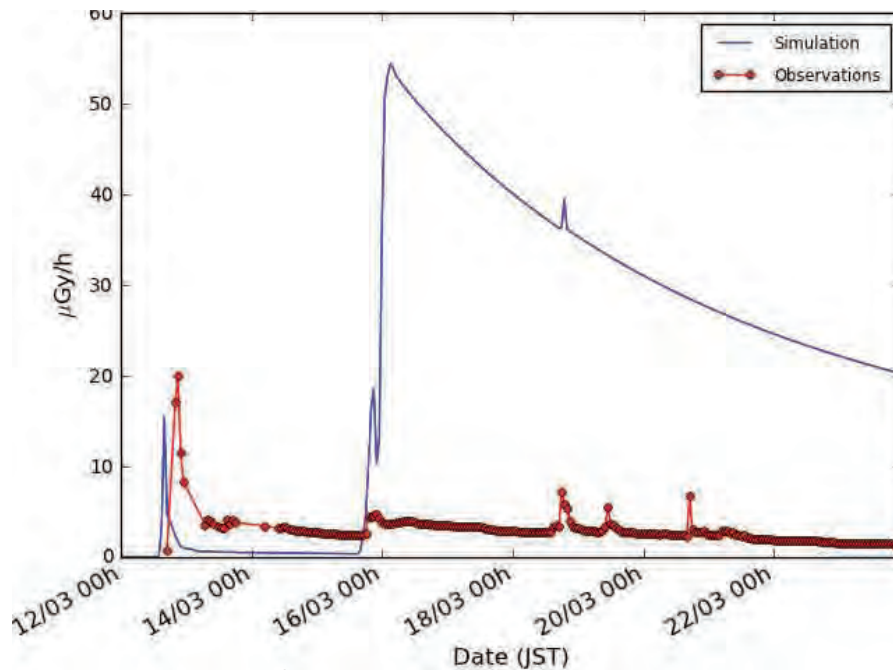

- Reactor 1: peak March 12 & 13
- Timing OK, amplitude rather good
- Peak due to R2 on March 16: wind too North

North-West stations: Iitate & Fukushima

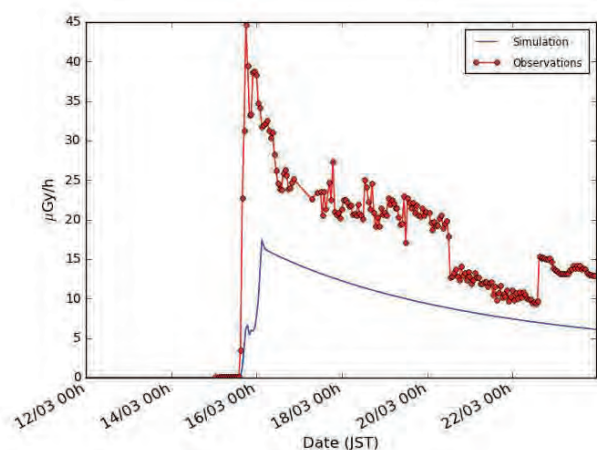
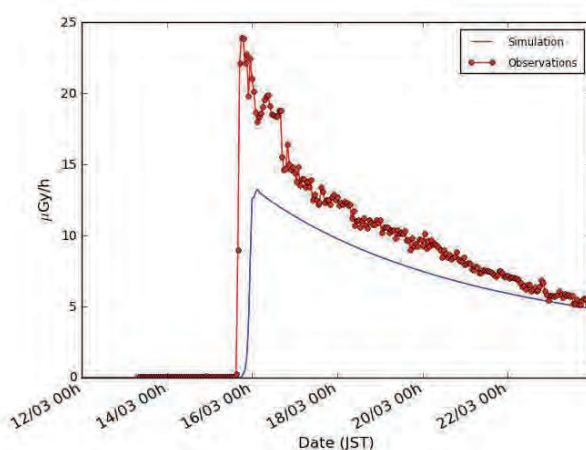

- Good evaluation of the dose rate for Iitate (40km) & Fukushima city (60 km)
- Small delay for the simulation of the plume passage

Conclusions

- The methodology adopted by the IRSN's *CTC* to assess the state of the different units of Fukushima Dai-Ichi site during the emergency situation faced by Japan in March 2011 and to evaluate the source term, looks pretty good.
- The *CTC*'s predicted behavior of the atmospheric releases shows-up in a fairly good agreement with observations in Japan.
- Nevertheless, complementary and more comprehensive studies are still necessary to evaluate the actual consequences of the releases, which are likely to affect the environment and the public in the medium-long term.

Introduction to the Restoration Roadmaps

***“Status of Fukushima NPS and
Roadmaps Towards Restoration & Decommissioning”***

Kunihisa Soda

Japan Atomic Energy Agency

Tokyo, Japan

Presented at the International Workshop,
“One Year After Fukushima: Rethinking the Future”,
ENEA, Bologna, Italy, March 15 and 16, 2012

Contents

1. Tohoku Pacific Ocean Earthquake and the Accident at Fukushima NPS
2. Status of Fukushima NPS
3. Roadmap Towards Restoration from the Accident
4. Mid-and-Long Term Roadmap Towards Decommissioning
5. Lessons Learned from the Accident

References

Note: Presentations by T. Satoh (2,3,4), T. Fujishiro (2), K. Saito (2), T. Bannai (5)

1. Tohoku Pacific Ocean Earthquake and the Accident at Fukushima NPS (Ref. 3.1)

- Time: 2:46 pm on Fri, March 11, 2011.
- Place: Offshore Sanriku coast (northern latitude of 38 degrees, east longitude of 142.9 degrees), 24km in depth, Magnitude 9.0
- Intensity: Level 7 at Kurihara in Miyagi prefecture
Upper 6 at Naraha, Tomioka, Okuma, and Futaba in Fukushima pref.
Lower 6 at Ishinomaki and Onagawa in Miyagi pref., Tokai in Ibaraki pref.
Lower 5 at Kariwa in Niigata pref.
Level 4 at Rokkasho, Higashidori, Mutsu and Ohma in Aomori pref., Kashiwazaki in Niigata pref.

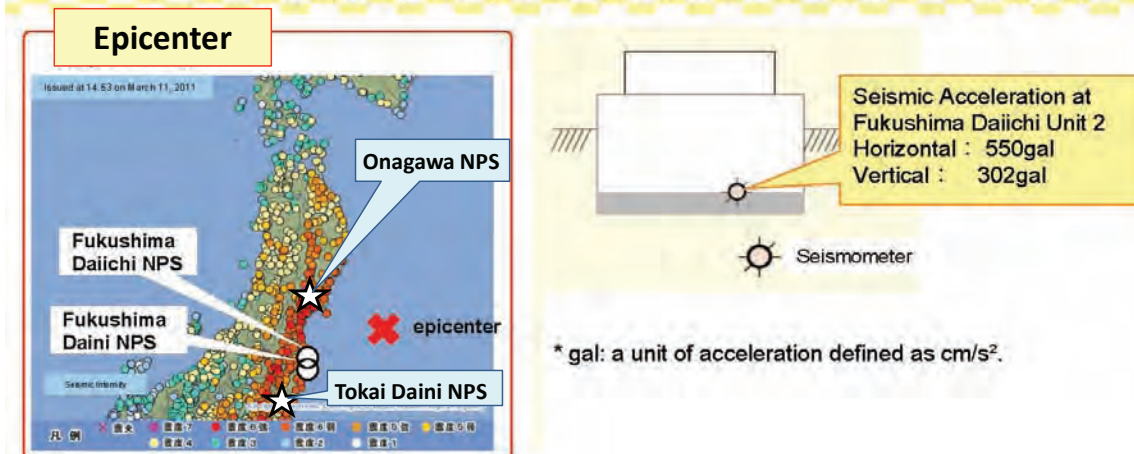

Tohoku Pacific Ocean Earthquake

Earthquakes and Coseismic Slip

Ref: (1) N. Hirata, *Gakushikaiho*, No.893, p84, March 2012, (2) GSI of Japan, <http://www.gsi.go.jp/common/000060854.pdf>

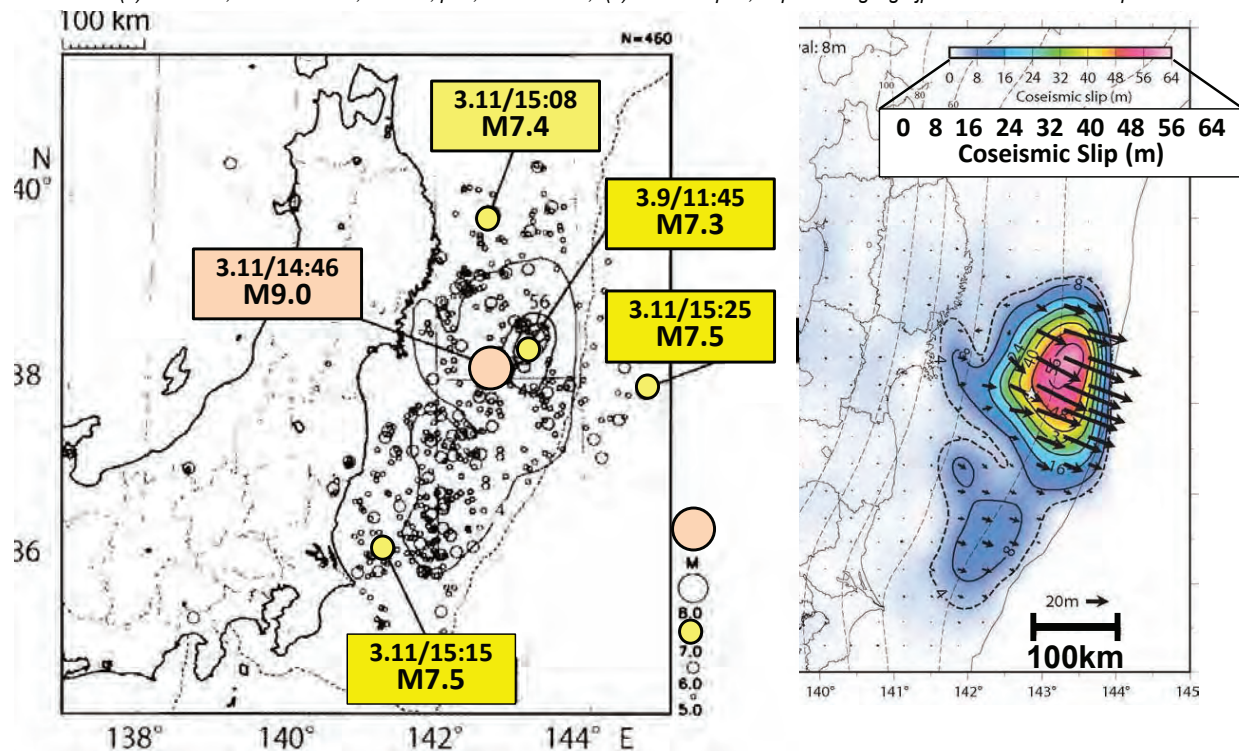

Tohoku Pacific Ocean Earthquake

Typical Earthquakes and Active Faults

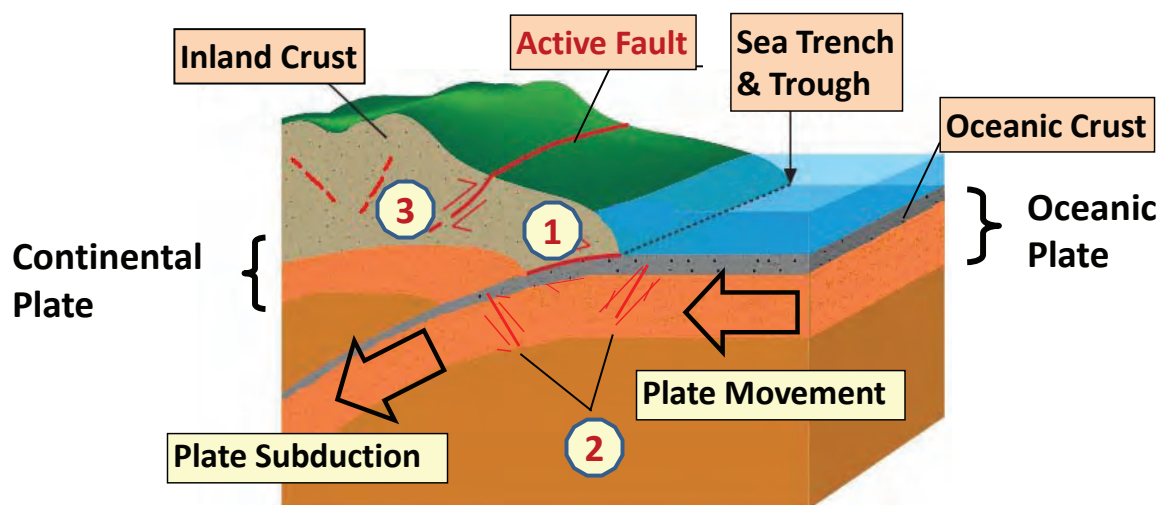

Earthquakes :

- ① Inter Plate E.Q. ,Inland,
- ② Intra Plate E.Q.,
- ③ Inside-crust E.Q.

Seismic Safety Analysis at Fukushima NPS

For the back-check analysis in 2009

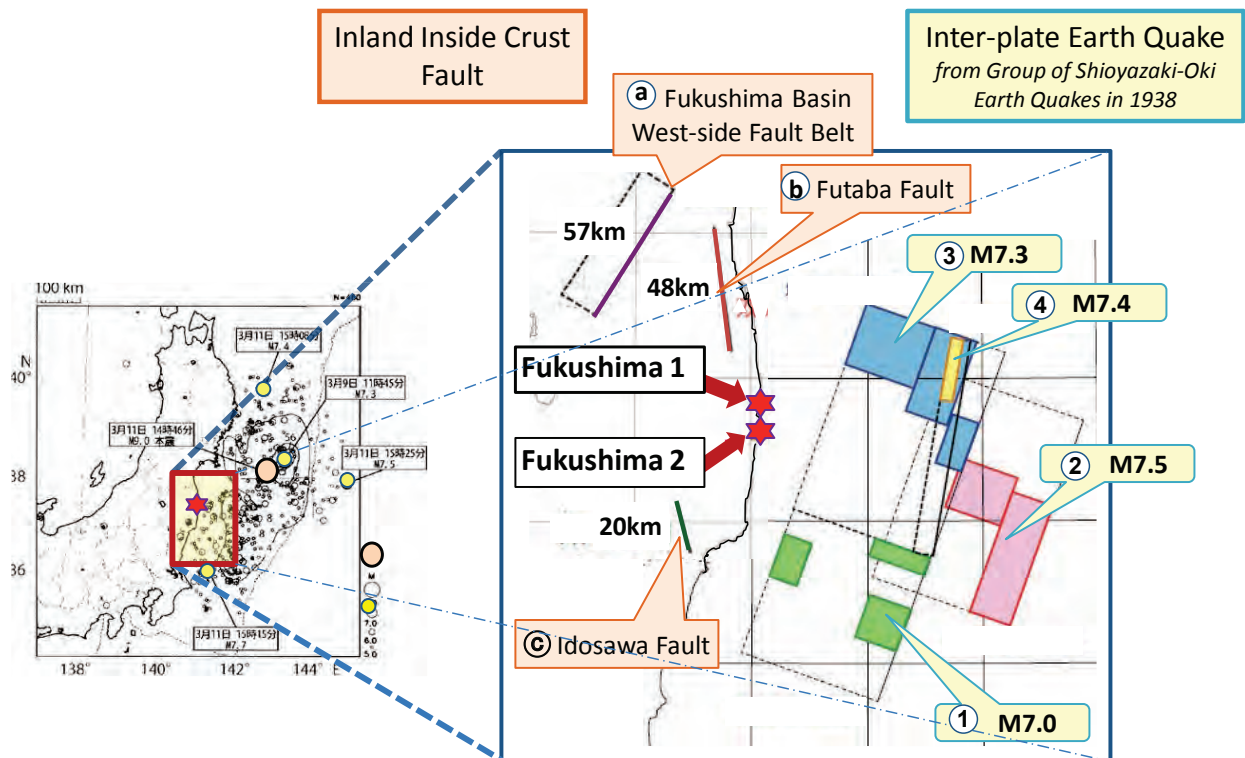

3/15/2012 KS/JAEA

ENEA Workshop, Bologna, Italy

6

Tsunami

At Fukushima Daiichi and Daini NPS

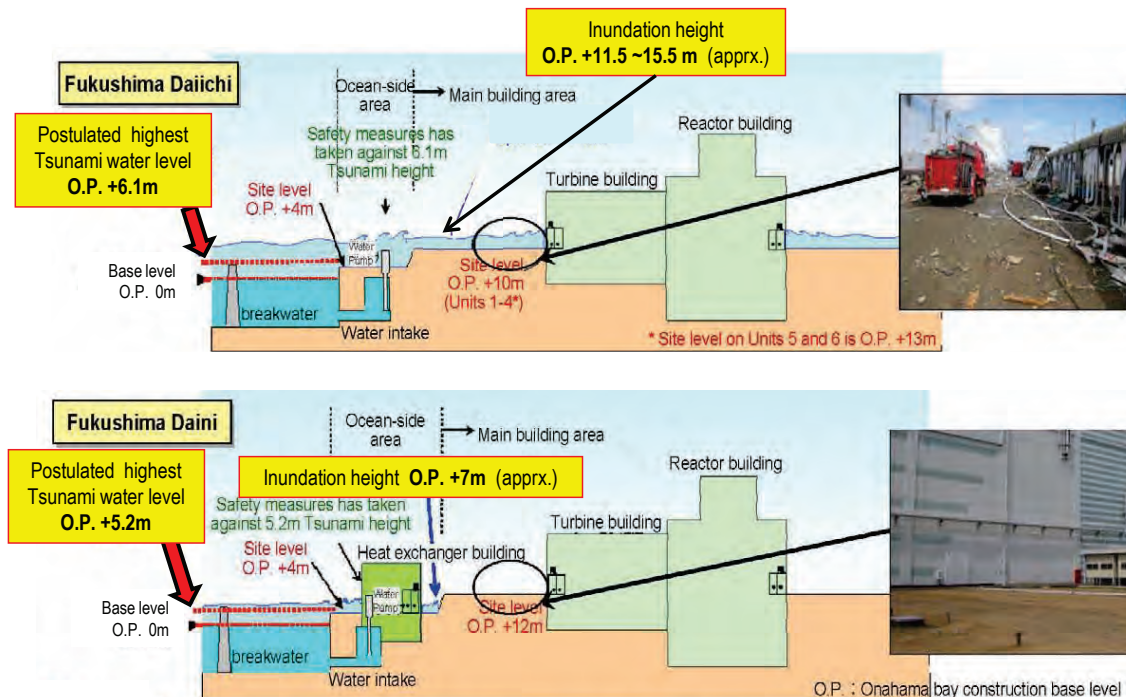

3/15/2012 KS/JAEA

ENEA Workshop, Bologna, Italy

7

Tsunami

At Onagawa NPS and Tokai Daini NPS

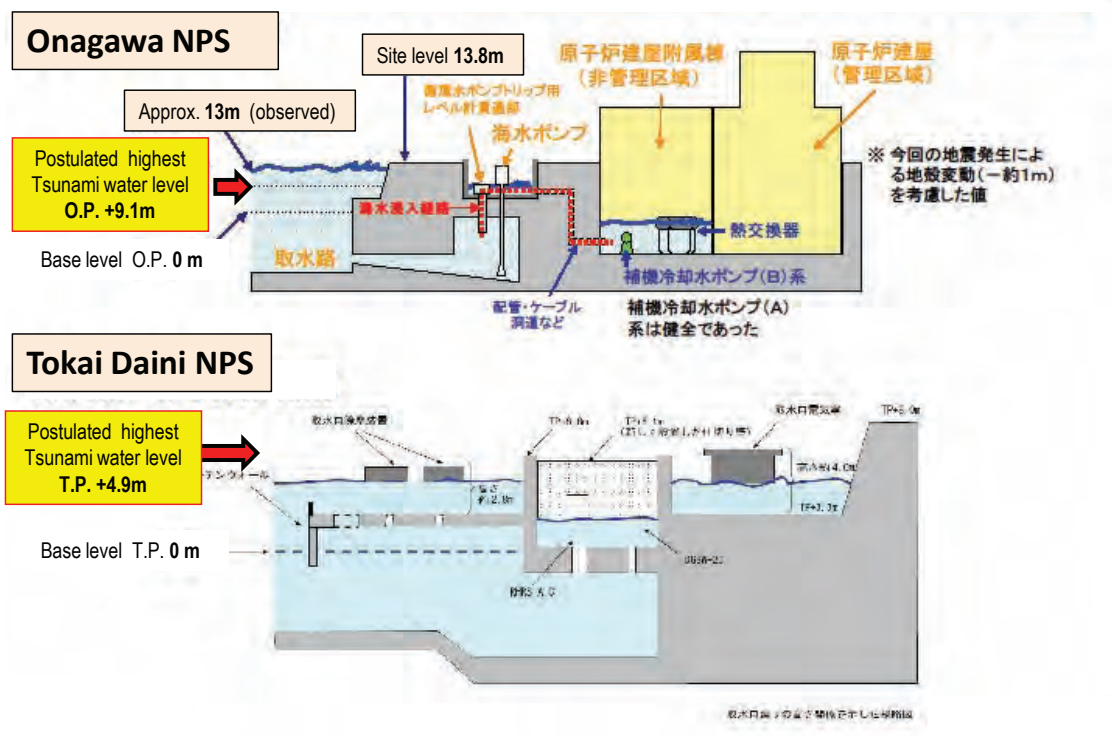

Damage by Tsunami

Comparison of damages to NPS

NPS	Fukushima Daiichi	Fukushima Daini	Onagawa	Tokai Daini
Ground Level	10m (Unit 1 to 4) 13m (Unit 5 to 6)	12m	14.8m	8 m
Postulated Inundation Height	5.4 to 5.7m	5.1 to 5.2m	9.1m	4.9m
Observed Inundation Height	14 to 15m	6.5 to 7m	13m	5.4m
External Power Emergency Generators	0/6 0/8 U1 to U4 1/5 U5, U6	1/4 3/12	1/5 6/8	0/3 2/3
Cooling	Injection N.A (U1 to U4) Lost seawater PMP (U5, U6)	Lost seawater PMP (U1, U2, U4)	Continued	Continued

Maximum Response Acceleration

Comparison with the licensing basis

Note: The licensing basis was exceeded.		Data			Licensing Basis ^(*)		
		Horizontal		Vertical	Horizontal		Vertical
		E-W	N-S		E-W	N-S	
Fukushima Daiichi	Unit 1	460	447	258	487	489	412
	Unit 2	348	550	302	441	438	420
	Unit 3	322	507	231	449	441	429
	Unit 4	281	319	200	447	445	422
	Unit 5	311	548	256	452	452	427
	Unit 6	298	444	244	445	448	415
Fukushima Daini	Unit 1	254	230	305	434	434	512
	Unit 2	243	196	232	428	429	504
	Unit 3	277	216	208	428	430	504
	Unit 4	210	205	288	415	415	504

Note: ^(*) Results of the back-check analysis of seismic safety based on the revised seismic safety design guideline.

2. Status of Fukushima NPS

- **Plant Status⁽¹⁾** (Ref. 3.2)
- **Monitoring Data and Evacuation^(2,3)** (Ref. 3.3)
 - Radioactive materials release⁽²⁾
 - Monitoring at the site boundary and the surroundings of Fukushima Daiichi NPS^(2,3)
 - Sheltering and Evacuation⁽³⁾

Note: Presentation by T. Satoh (1), T. Fujishiro (2), K. Saito (3).

Plant Status

Plant parameters at Fukushima NPS*

Note: * as of January 27, 2012

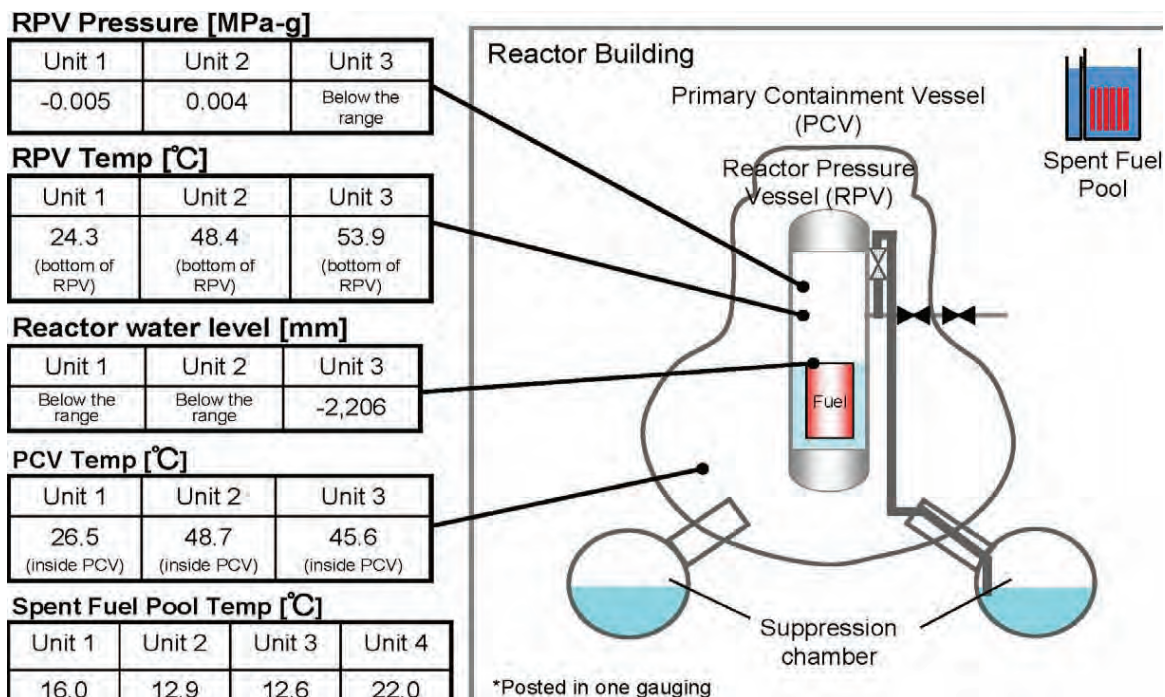

Monitoring Data

At the Site Boundary of Fukushima Daiich NPS

Air Dose Rate ($\mu\text{Sv/h}$) at the Monitoring posts
as of 12:00 on January 26, 2012



Dose Rates Trend at the Site Boundary of Fukushima Daiichi NPS

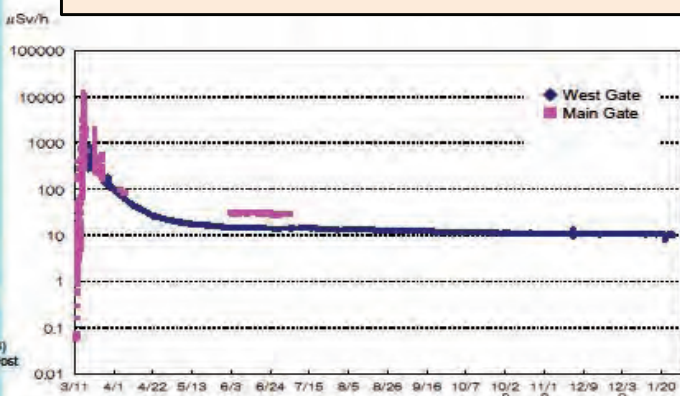

Monitoring Data

In the surroundings of Fukushima Daiichi NPS

Readings at reading points out of TEPCO Fukushima Dai-ichi NPS

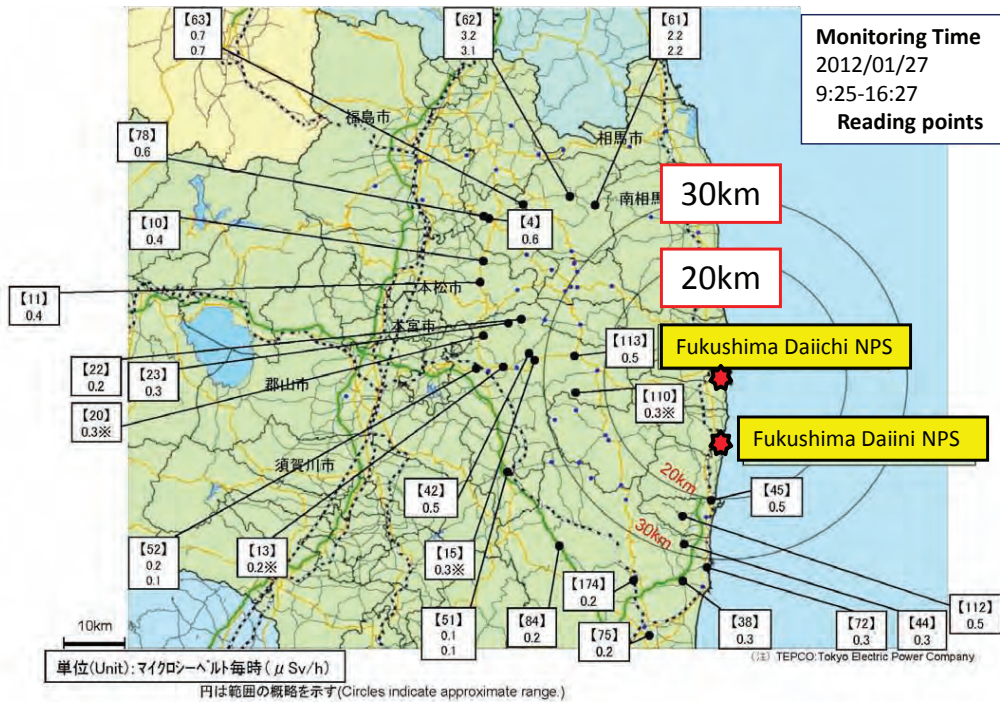

Sheltering and Evacuation

Emergency declaration by the Government (19:03 March 11, 2011)

- Fri, March 11**
 - 14:46 The earthquake occurred
 - 19:03 Emergency Declaration by the Gov't (Daiichi)
 - 21:23 3 km radius evacuation (Daiichi)
 - 10 km radius taking shelter (Daiichi)
- Sat, March 12**
 - 5:44 10 km radius evacuation (Daiichi)
 - 7:45 3 km radius evacuation (Daini), 10 km radius taking shelter (Daini)
 - 17:39 10 km radius evacuation (Daini)
 - 18:25 20 km radius evacuation (Daiichi)
- Tue, March 15**
 - 11:00 20-30 km radius taking shelter (Daiichi)
- Thu, April 21**
 - 11:00 20 km radius is designated as "Restricted Area" (Daiichi)
 - Beyond 8km radius of evacuation has been lifted. (Daini)
- Fri, April 22**
 - 9:44 20-30 km radius taking shelter has been lifted (Daiichi)
 - Establishment of "Deliberate Evacuation Area" and "Emergency Prepared Area in Case of Emergency"
- Thu, June 16**
 - PM Establishment of "Specific Locations Recommended for Evacuation"
- Fri, September 30**
 - 18:11 Evacuation Prepared Area in case of Emergency has been lifted.
- Mon, December 26**
 - Governmental Emergency Declaration was lifted (Daini)

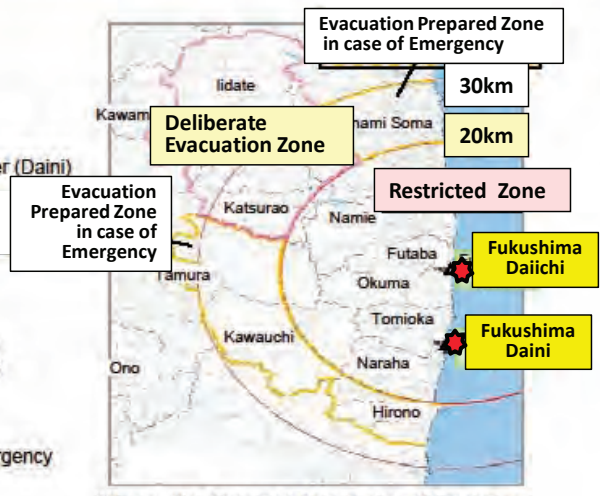

※Evacuation Prepared Area in case of Emergency

has been lifted on Sep.30

Source: NISA website

3. Roadmap Towards Restoration

Goals and Issues of Step 1 and Step 2 (Ref. 3.2)

- **Goals**
 - **Stable condition, Condition equivalent to cold shut-down state, and Significant reduction of radioactive materials release to the environment.**
- **Issues**
 - I. Cooling, II. Mitigation, III. Monitoring and Decontamination, IV. Counter measures against aftershock etc., V. Environment restoration
- **Completion of Step 1 & 2 was confirmed.**
 - Stable circulation of cooling water has been established and secured.
 - Radiation dose at the site boundaries has reached at sufficiently low level.

Roadmap Towards Restoration

Completion of Step 1 & Step 2 (1/2) Dec.16, 2011

December 16, 2011
Nuclear Emergency Response Headquarters
Government-TEPCO Integrated Response Office

Current Status of "Roadmap towards Restoration from the Accident at Fukushima Daiichi Nuclear Power Station, TEPCO" (Step 2 completion)

As of Apr. 17 (first announcement) | Step 1 (around 3 months) | Step 2 (through the end of this year) | current status (as of Dec. 16) | Mid-term issues (around 3 years)

Issues	As of Apr. 17 (first announcement)	Step 1 (around 3 months)	Step 2 (through the end of this year)	current status (as of Dec. 16)	Mid-term issues (around 3 years)	
I. Cooling	(1) Reactor Fresh water injection	Cooling by minimum injection rate (injection cooling)	Circulating water cooling (start)	Stable cooling	Circulating water cooling (continued)	Maintain and Continue cold shutdown condition
		Consideration and preparation of reuse of accumulated water			Nitrogen gas injection (continued)	Nitrogen gas injection
	(2) Steam generator injection	Nitrogen gas injection	Improvement of work environment	Stable cooling	Remote-controlled injection operation	Protection against corrosion cracking of structural materials* (priority ahead of schedule)
		Reliability improvement in injection operation / remote-control operation "ahead of schedule"	Circulation cooling system (installation of heat exchanger)* (partially ahead of schedule)		Consideration / installation of heat exchanging function	Start of removal work of fuels
II. Mitigation	(3) Nonradioactive Water	Transferring water with high radiation level	Installation of storage / processing facilities	Secure storage place	Expansion of / consideration of full-fledged processing facilities	Installation of full-fledged water processing facilities
		Storing water with low radiation level	Installation of storage facilities / decontamination processing		Decontamination / desalination processing (reuse), etc.	Continuous processing of accumulated water
	(4) Ground Water	Mitigation of contamination in groundwater	Mitigation of contamination in groundwater	Reduce amount of accumulated water	Storage / management of sludge waste etc.	Research on processing of sludge waste etc.
		Consideration of method of impermeable wall against groundwater	Mitigation of contamination in the ocean	Mitigation of contamination in the ocean	Design / implementation of impermeable wall against groundwater	Mitigation of contamination in the ocean
	(5) Aerosol / Sol	Dispersion of inhibitor	Dispersion of inhibitor (continued)	Mitigate aerosol	Restoration of sub-drainage pumps with expansion of storage / processing facilities	Mitigation of contamination in groundwater
		Removal / management of debris	Removal / management of debris (continued)	Mitigate aerosol	Design / implementation of impermeable wall against groundwater	Establishment of impermeable wall against groundwater
					Dispersion of inhibitor	
					Removal / management of debris	
					Removal of debris / installation of reactor building cover (Unit 3&4)	
					Start of installation work of reactor building container	
					Installation of PCV gas control system	

All Rights Reserved ©2012The Tokyo Electric Power Company, Inc.

Roadmap Towards Restoration

Completion of Step 1 & Step 2 (2/2) Dec.16, 2011

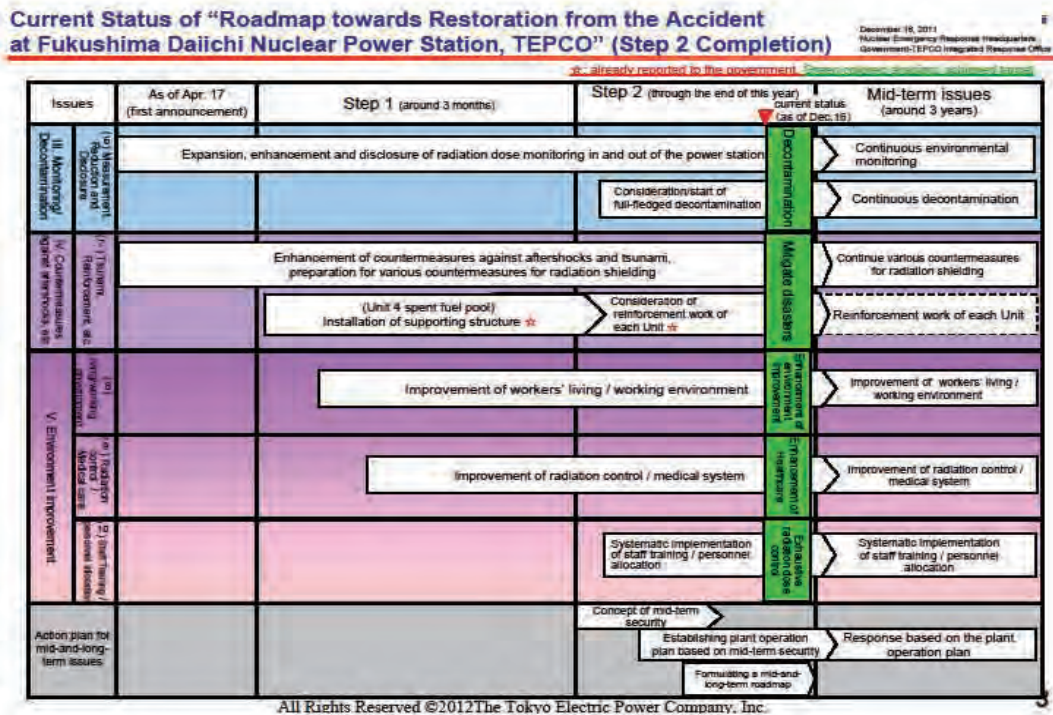

4. Mid-and-Long Term Roadmap

Towards the end of decommissioning (Ref. 3.4)

Phase 1 (within 2 years*):

From the end of Step 2 to start of fuel removal

- Fuel removal from the spent fuel pool (Unit 4)
- R&D for RW processing and disposals

Phase 2 (within 10 years*)

From the end of Phase 1 to start fuel debris removal

- Fuel debris removal
- R&D for RW reprocessing and debris removal

Phase 3 (within 30 to 40 years*)

From the end of Phase 2 to the end of decommissioning

- Complete removal of fuel debris (20 to 25 years*)
- Complete the decommissioning (30 to 40 years*)
- Implement RW processing and disposal

Note: (*) Years after the completion of Step 2

Mid-and-Long Term Roadmap

Towards the end of decommissioning

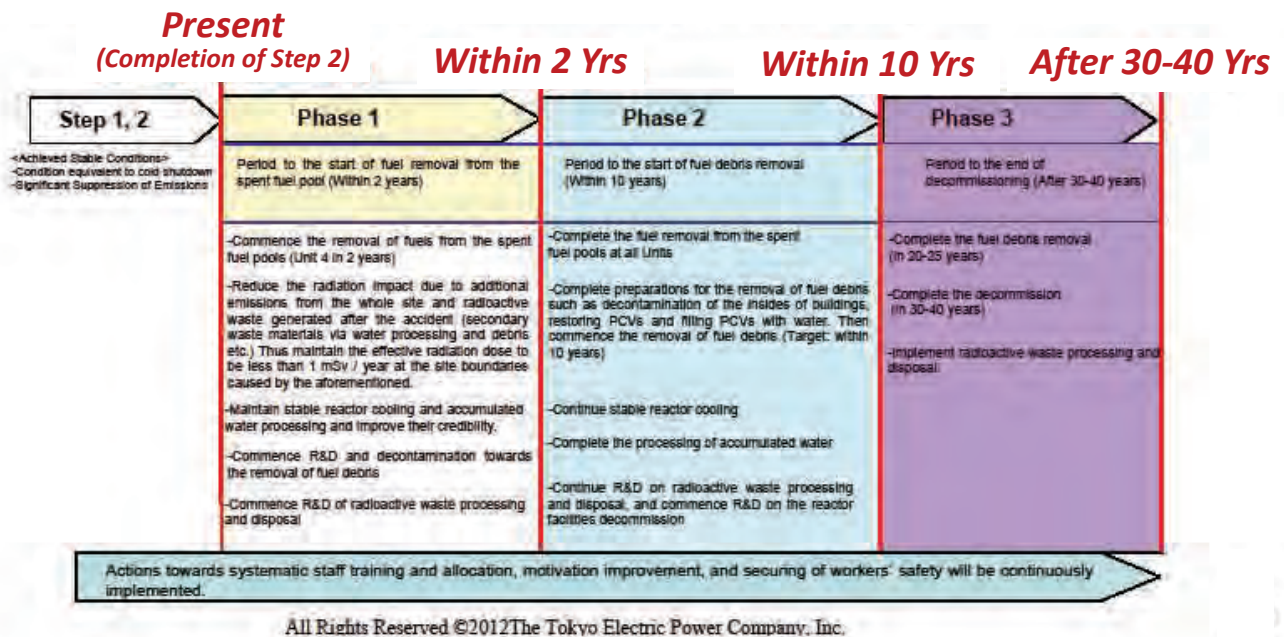

All Rights Reserved ©2012The Tokyo Electric Power Company, Inc.

R&D for new technology is needed for achieving goals of the Mid-and-Long Term Roadmap.

Issues for Technology Development

Removal of Fuel Debris

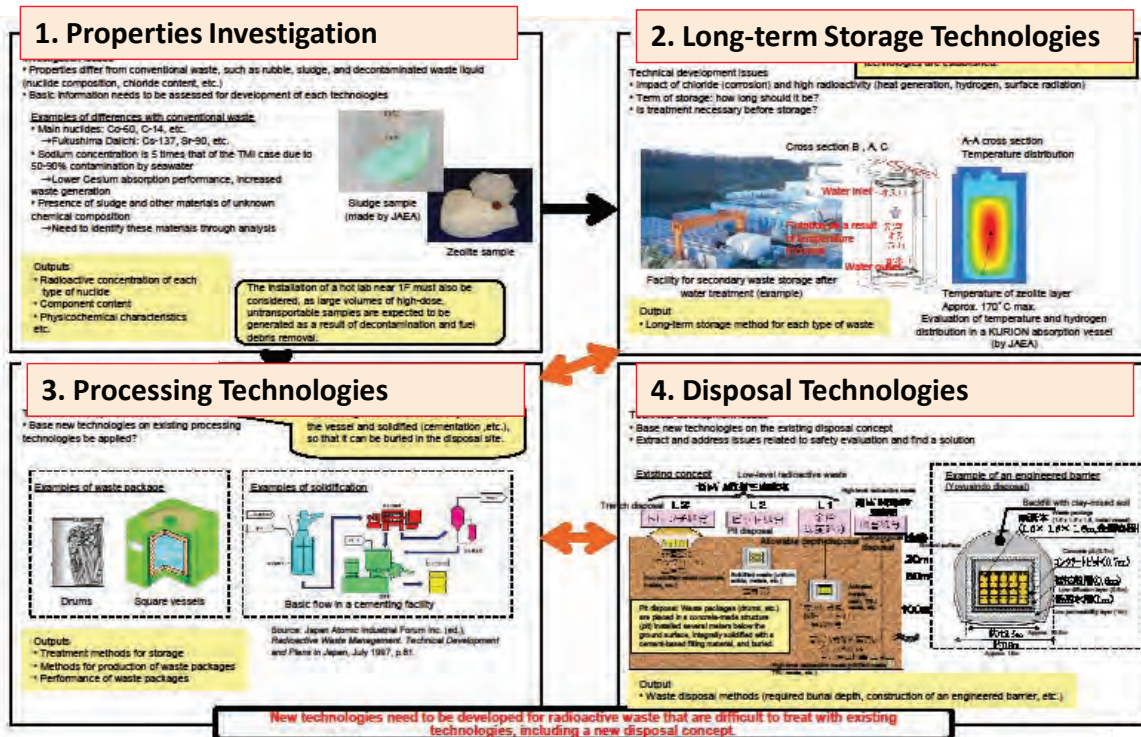

All Rights Reserved ©2012The Tokyo Electric Power Company, Inc.

Issues for Technology Development

Radioactive waste processing and disposal

Remote Decontamination

- Development of technologies for remote decontamination of the reactor building interior
- Overview: Remote decontamination devices that match onsite contamination conditions will be developed to improve the work environment for surveying and repairing leak areas, etc.
- Technical development issues: Assessment and development of effective decontamination technologies in response to contamination type.
- Development of technologies for high-dose areas: Decontamination (strip-down paint)
- High-pressure water: Self-propelled blasting, Strip-down paint

Survey leak locations and their size in PCV

- Development of technologies for identification of leak areas in the PCV
- Overview: Technologies for remote identification of leak areas in the PCV, etc. will be developed.
- Technical development issues: Development of environments, etc.
- Environments (examples): (1) S/C shell, (2) S/C penetration, (3) S/C, (4) S/C, (5) Vent cover, (6) Vent pipe below, (7) S/C, (8) S/C, (9) S/C, (10) S/C, (11) S/C, (12) S/C, (13) S/C, (14) S/C, (15) S/C, (16) S/C, (17) S/C, (18) S/C, (19) S/C, (20) S/C, (21) S/C, (22) S/C, (23) S/C, (24) S/C, (25) S/C, (26) S/C, (27) S/C, (28) S/C, (29) S/C, (30) S/C, (31) S/C, (32) S/C, (33) S/C, (34) S/C, (35) S/C, (36) S/C, (37) S/C, (38) S/C, (39) S/C, (40) S/C, (41) S/C, (42) S/C, (43) S/C, (44) S/C, (45) S/C, (46) S/C, (47) S/C, (48) S/C, (49) S/C, (50) S/C, (51) S/C, (52) S/C, (53) S/C, (54) S/C, (55) S/C, (56) S/C, (57) S/C, (58) S/C, (59) S/C, (60) S/C, (61) S/C, (62) S/C, (63) S/C, (64) S/C, (65) S/C, (66) S/C, (67) S/C, (68) S/C, (69) S/C, (70) S/C, (71) S/C, (72) S/C, (73) S/C, (74) S/C, (75) S/C, (76) S/C, (77) S/C, (78) S/C, (79) S/C, (80) S/C, (81) S/C, (82) S/C, (83) S/C, (84) S/C, (85) S/C, (86) S/C, (87) S/C, (88) S/C, (89) S/C, (90) S/C, (91) S/C, (92) S/C, (93) S/C, (94) S/C, (95) S/C, (96) S/C, (97) S/C, (98) S/C, (99) S/C, (100) S/C

Remote survey of the inside of PCV

- Development of technologies for remote survey of the inside of PCV
- Overview: Remote measures and technologies will be developed to repair and stop leaks in leaking areas (Torus room, PCV, etc.).
- Technical development issues: Development of remote repair technologies for severe environments, such as high-dose areas, narrow spaces, etc. Repair technologies applicable to underwater environments (lower part of the PCV, etc.)
- Penetration hole repair technologies (examples): Steel ring (reinforcement of sealing area), Steel cover (secondary boundary for the hatch), Spider with holding ring
- System for prevention of radioactive dispersal: Camera, Mirror, PCV

Re-enforce PCV

- Development of PCV Repair Technologies
- Overview: Remote measures and technologies will be developed to repair and stop leaks in leaking areas (Torus room, PCV, etc.).
- Technical development issues: Development of remote repair technologies for severe environments, such as high-dose areas, narrow spaces, etc. Repair technologies applicable to underwater environments (lower part of the PCV, etc.)
- Penetration hole repair technologies (examples): Steel ring (reinforcement of sealing area), Steel cover (secondary boundary for the hatch), Spider with holding ring
- Air lock, Turbocable, Seal packing, Turbocable

All Rights Reserved ©2012 The Tokyo Electric Power Company, Inc.

5. Lessons Learned from the Accident

To the future (1/2)

Remarks

- Safety regulation and requirements in Japan do not specifically request in the licensing process to assess margin of safety against events of low probability but high risk consequence.
- Based on lessons learned from the Fukushima Accident, regulators and stakeholders have initiated to reassess safety of all existing NPPs against such events to confirm robustness, and if found necessary, to improve and enhance safety.

Investigation by the Government Team

- The preliminary conclusions (Ref. 4)
 - Lack of severe accident measures against tsunami,*
 - Lack of view point of complex disaster, and*
 - Lack of viewpoint of looking at the whole picture of accident.*
- The investigation continues.

5. Lessons Learned from the Accident

To the future (2/2)

Reassessment of Safety of NPS (Ref 5)

- Regulators , NISA and NSC, requested all utilities to reassess safety of NPP to confirm their robustness against extreme cases beyond the design basis. (July 2011)
- Submission of the reports of reassessment and their review has started recently.

Restructure of regulatory organizations (Ref. 6)

- The Cabinet Office has initiated to restructure the existing organizations for nuclear safety regulation, NSC, NISA and part of MEXT, and establish a single and independent nuclear regulatory organization under the Ministry of Environment.

References

1. Nuclear Emergency Response Head Quarters, Government of Japan:
 - 1.1 Report of Japanese Government to the IAEA Ministerial Conference on Nuclear Safety - The Accident at TEPCO's Fukushima Nuclear Power Stations- , June 2011
(http://www.kantei.go.jp/foreign/kan/topics/201106/iaea_houkokusho_e.html)
 - 1.2 Additional Report of the Japanese Government to the IAEA (Second Report), Sept. 2011
(http://www.meti.go.jp/english/earthquake/nuclear/iaea/iaea_110911.html)
2. MEXT: Readings at Reading Points out of TEPCO Fukushima Dai-ichi NPP, Jan. 27, 2012
(<http://radioactivity.mext.go.jp/en> Then look for "Readings at monitoring post out of 20 km zone of Fukushima Daiichi NPP.")
3. TEPCO: "The Great East Japan Earthquake and Current Status of Nuclear Power Station" (*), Jan. 27, 2012,
Note: (*) Report contains materials for which all rights are reserved by TEPCO.
(http://www.tepco.co.jp/en/nu/fukushima-np/f1/images/f12np-gaiyou_e_1.pdf)
 - 3.1 Overview of the Earthquake & Tsunami and Nuclear Accident, Jan. 27, 2012 (updated)
 - 3.2 Roadmap towards Restoration from the Accident (Step 2 completed), as of Jan. 27, 2012
 - 3.3 Current Status of Fukushima Daiichi Nuclear Power Station, as of Jan. 27, 2012
 - 3.4 Mid-and-long Term Roadmap, as of Jan. 27, 2012
4. The Investigation Committee on the Accident at Fukushima NPS of TEPCO: "Executive Summary of the Interim Report" Dec. 26, 2011, (<http://icanps.go.jp/eng/interim-report.html>)
5. NISA: "Regarding the Implementation of Comprehensive Assessments for the Safety of Existing Power Reactor Facilities Taking into Account the Accident at Fukushima Dai-ichi Nuclear Power Station, Tokyo Electric Power Co. Inc.", Aug.30,2011, (<http://www.nisa.meti.go.jp/english/press/2011/08/en20110831-2.html>)
6. Cabinet Secretariat, Government of Japan: "Nuclear Safety Regulation Reform in Japan", The International Workshop on Nuclear Safety Regulation, Tokyo, Japan, Jan.18, 2012
(http://www.cas.go.jp/jp/genpatsujiko/info/kokusaiws/siryu/reform_of_regulation.pdf)

Status and perspectives of plant restoration process

March, 2012

Takashi Sato

Tokyo Electric Power Company

What I will present

1. Current status of 1F site
 - Plant parameters
 - Monitoring data
2. Completion of Step 2 (Cold shutdown condition)
 - Water processing facility / water supply system
 - Other achievements
3. Mid- and long-term roadmap toward decommissioning
 - Main issues to be solved
 - Work steps for fuel debris removal
 - R&D
4. Lessons learned and countermeasures
 - Lessons learned
 - Countermeasures at Kashiwazaki-Kariwa NPS

1. Current Status of 1F Site

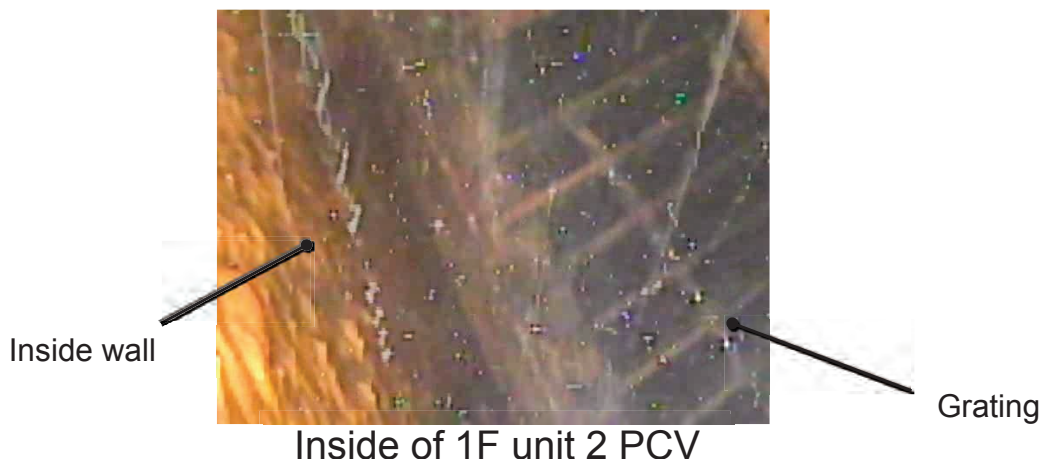

Plant Parameters (1F) as of March 5 at 5:00

RPV Pressure [MPa-g]

Unit 1	Unit 2	Unit 3
-0.005	0.014	Below the range

RPV Temp [°C]

Unit 1	Unit 2	Unit 3
23.5 (bottom of RPV)	43.4 (bottom of RPV)	53.8 (bottom of RPV)

Reactor water level [mm]

Unit 1	Unit 2	Unit 3
Below the range	Below the range	-2,169

PCV Temp [°C]

Unit 1	Unit 2	Unit 3
24.4 (HVH return)	51.1 (HVH return)	45.7 (HVH return)

Spent Fuel Pool Temp [°C]

Unit 1	Unit 2	Unit 3	Unit 4
26.5	12.9	12.7	24.0

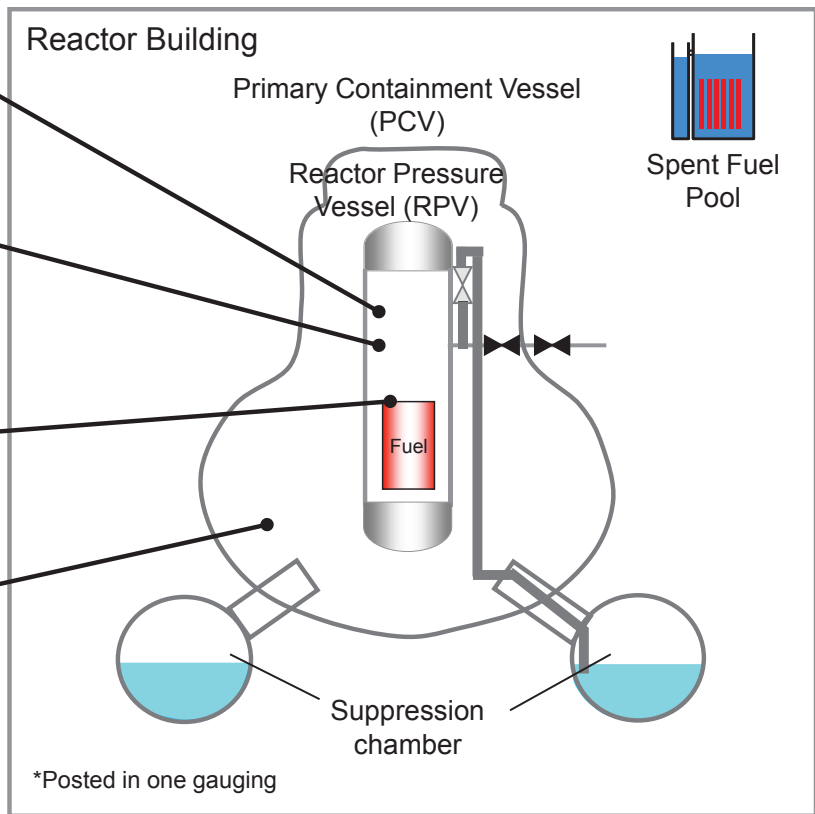

*We are judging the plant status comprehensively by utilizing data from multiple instruments and their trend, considering that some of the instruments may be showing inaccurate data due to abnormal condition for use.

Pressure conversion: Gauge pressure (MPa-g)=absolute pressure (MPa-abs)-atmospheric pressure(0.1013Mpa)



All Rights Reserved ©2011The Tokyo Electric Power Company, Inc.

Temperature inside PCV got low and stable

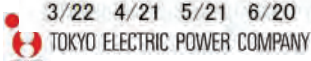
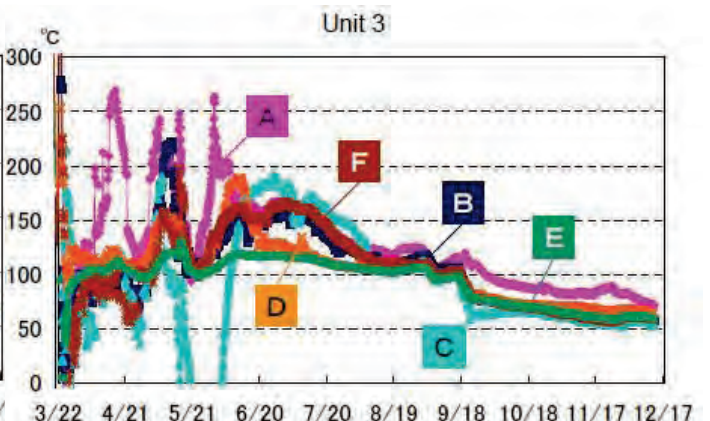
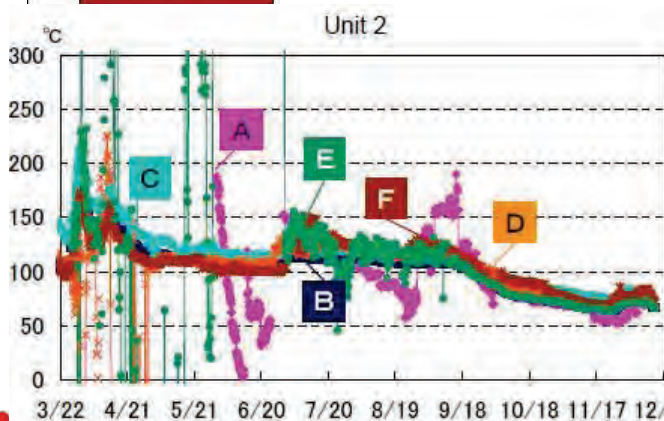
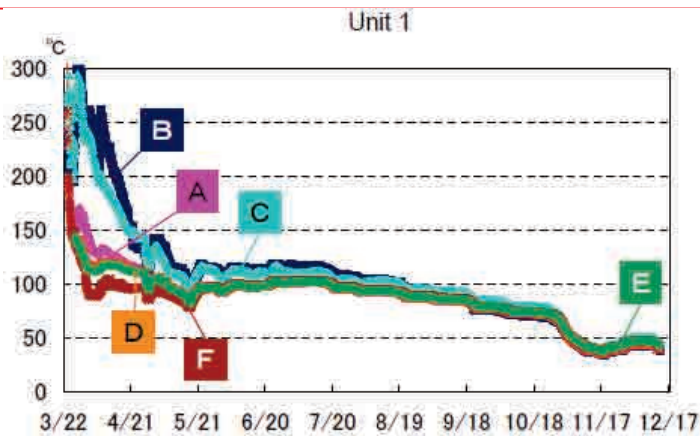
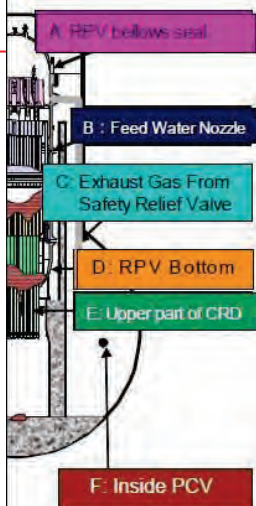

All Rights Reserved ©2012The Tokyo Electric Power Company, Inc.

Measurement of Radiation Dose at the Power Station

- Onsite dose map has been compiled and attention has been called upon workers to reduce exposure during works on the site.
- Many debris are on the site and some of them have high radiation dose. These debris are being removed by using heavy machineries.

Fukushima Daiichi survey map (as of Jan. 10, 2012 at 17:00)

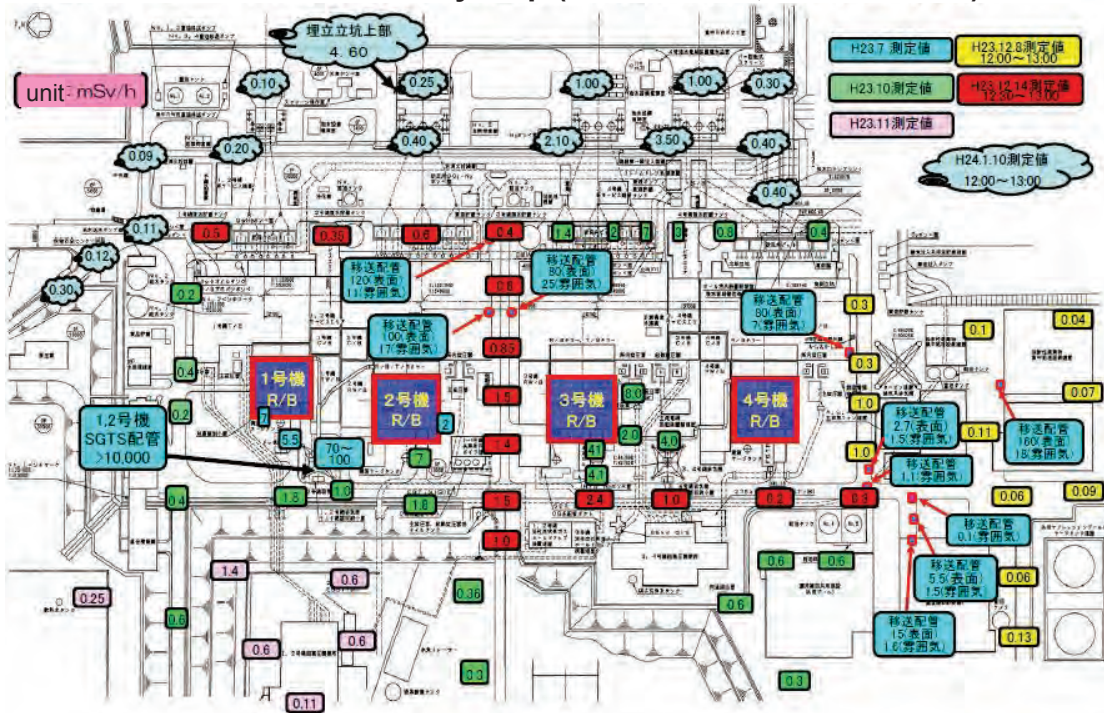

All Rights Reserved ©2011 The Tokyo Electric Power Company, Inc.

Monitoring Data (at Site Boundary of Fukushima Daiichi)

- Monitoring data at the site boundary of 1F.
- We continue to monitor the surrounding environment.

Monitoring post air dose rate

$\mu\text{Sv/h}$ as of 12:00 on January 26, 2012

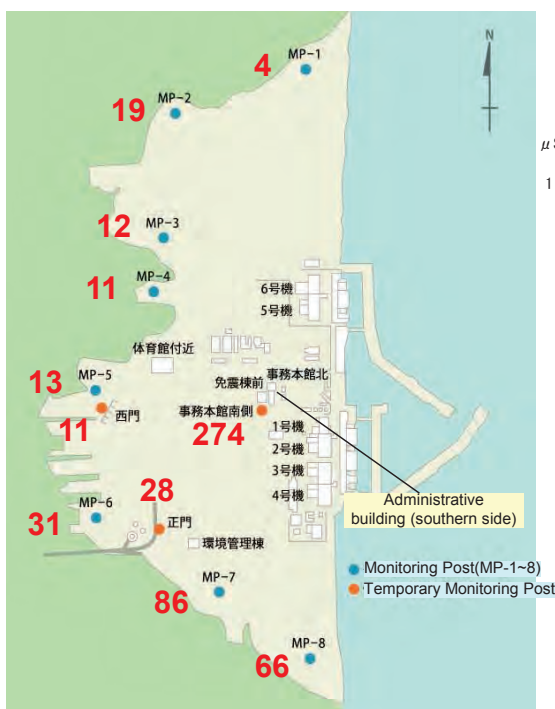

Dose Rate Trend at the Site Boundary of 1F

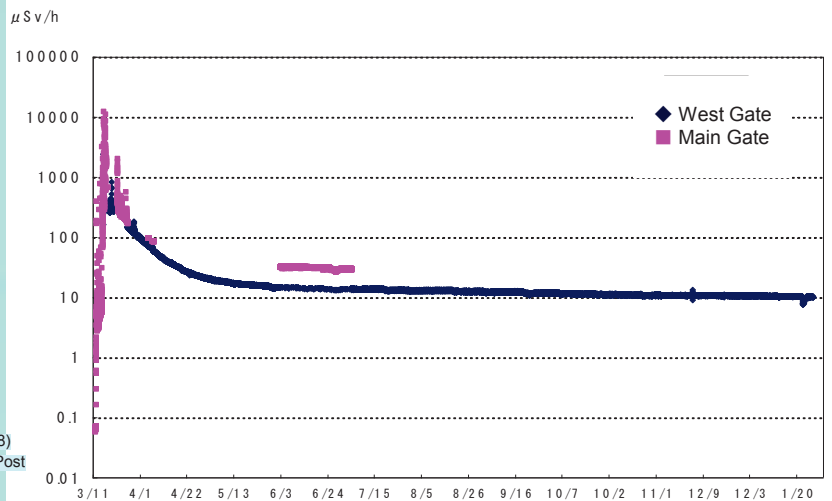

All Rights Reserved ©2011 The Tokyo Electric Power Company, Inc.

Release Rate of Radioactive Cs from 1F-1~3

Release rate (Bq/hour)

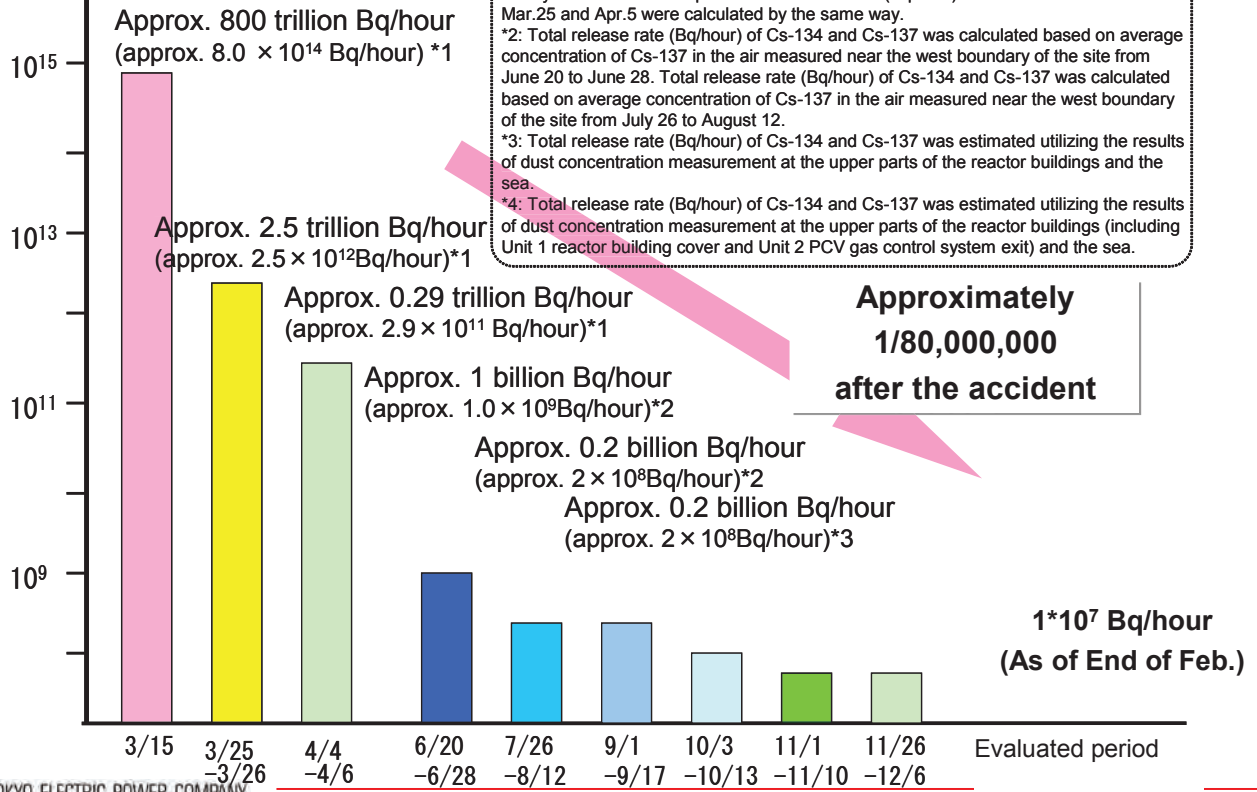

All Rights Reserved ©2012The Tokyo Electric Power Company, Inc.

7

Soil Radioactive Concentration

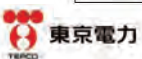
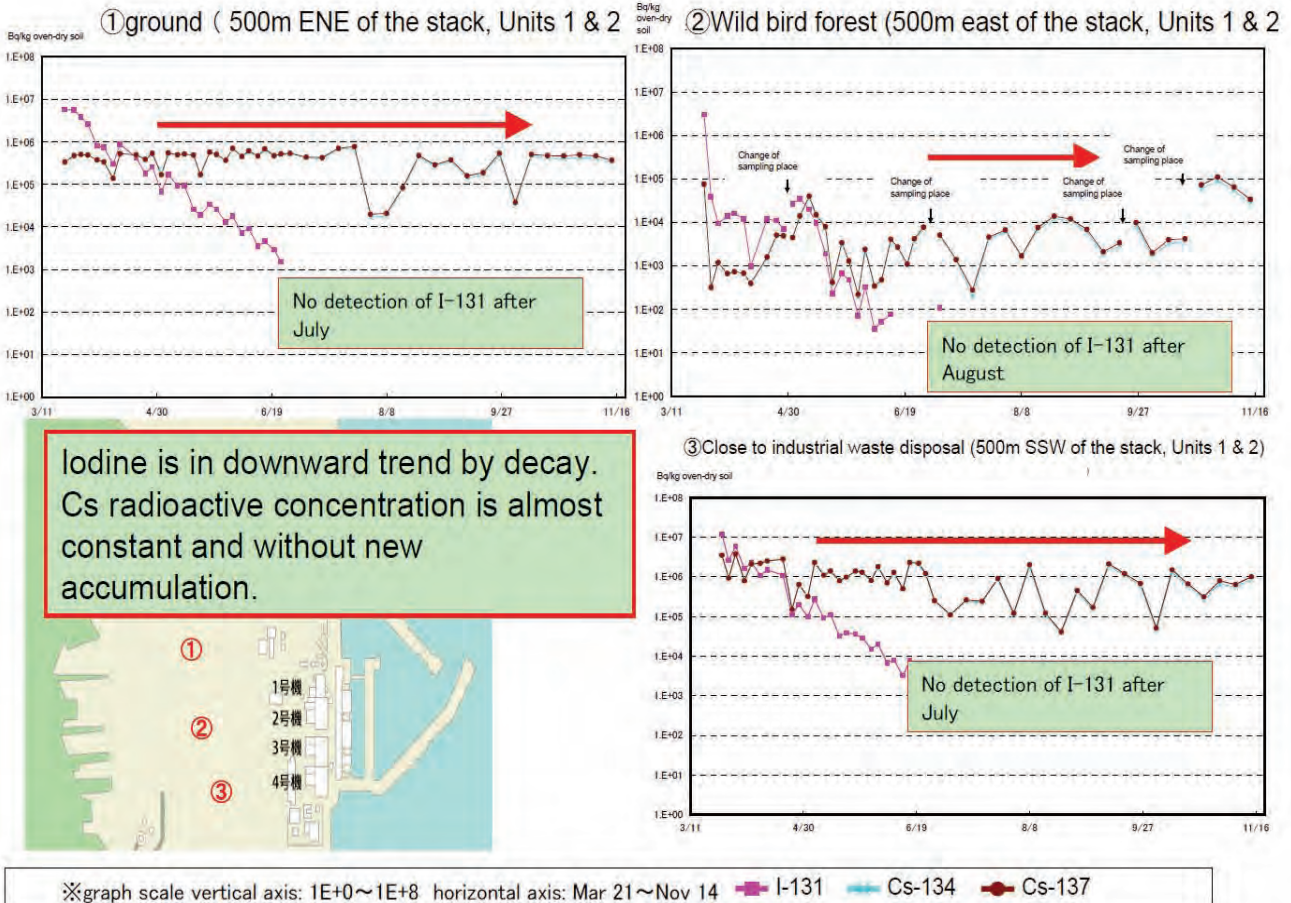

8

Seawater radioactive concentration

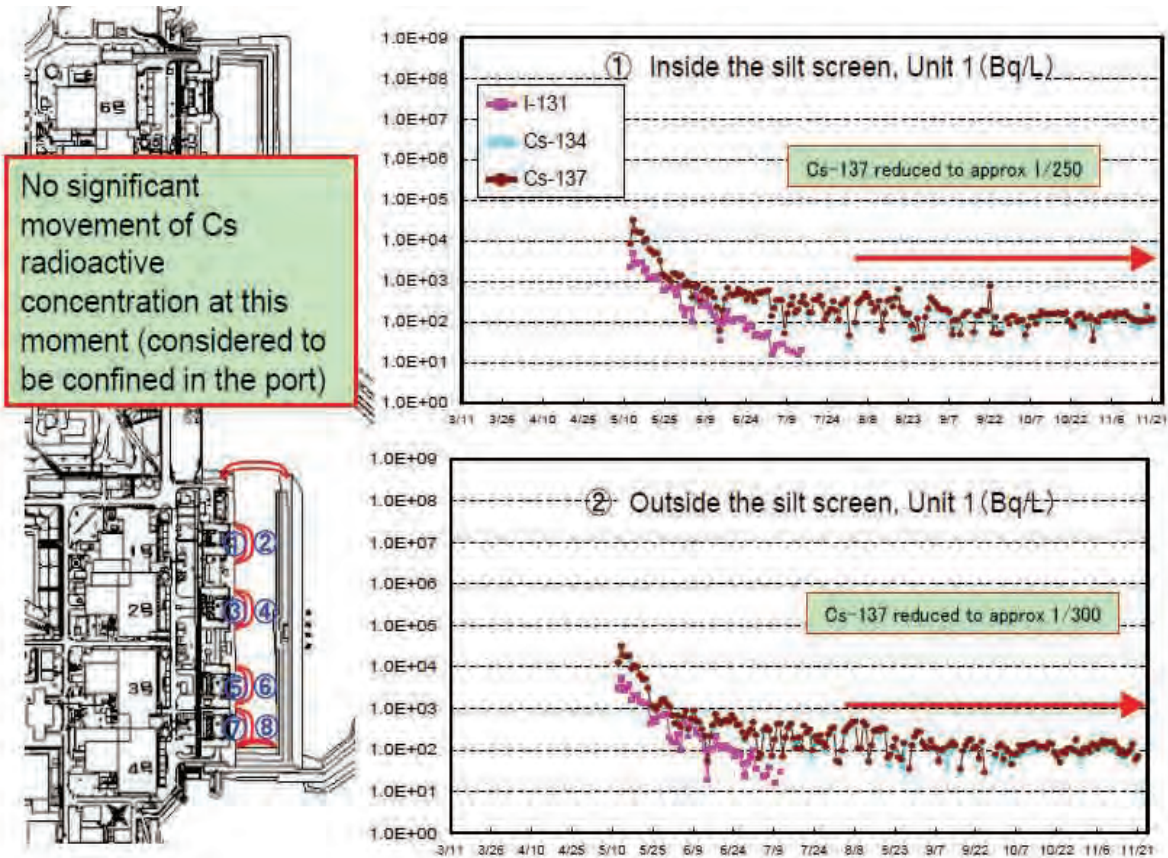

Contamination inside 1F-1/3 Reactor Buildings

Debris, fine particles and contaminated damaged equipments spread on the floor due to hydrogen explosion
Highly contaminated in the reactor buildings



Unit-1 Isolation Condenser Room



Unit-3 West Aisle in R/B 1st Floor



Unit-3 Stairs to 3rd Floor in R/B

Contamination inside 1F-2 Reactor Buildings

Little damage of buildings, but wide spread cesium contamination due to high temperature and humidity of building
 Contamination level much lower than that of unit 1 and 3



Unit-2 5th Floor (Operating Floor)



Unit-2 Aisle on 3rd Floor in R/B

(Figure) Dose Rate Map of 1F-1 1st Floor

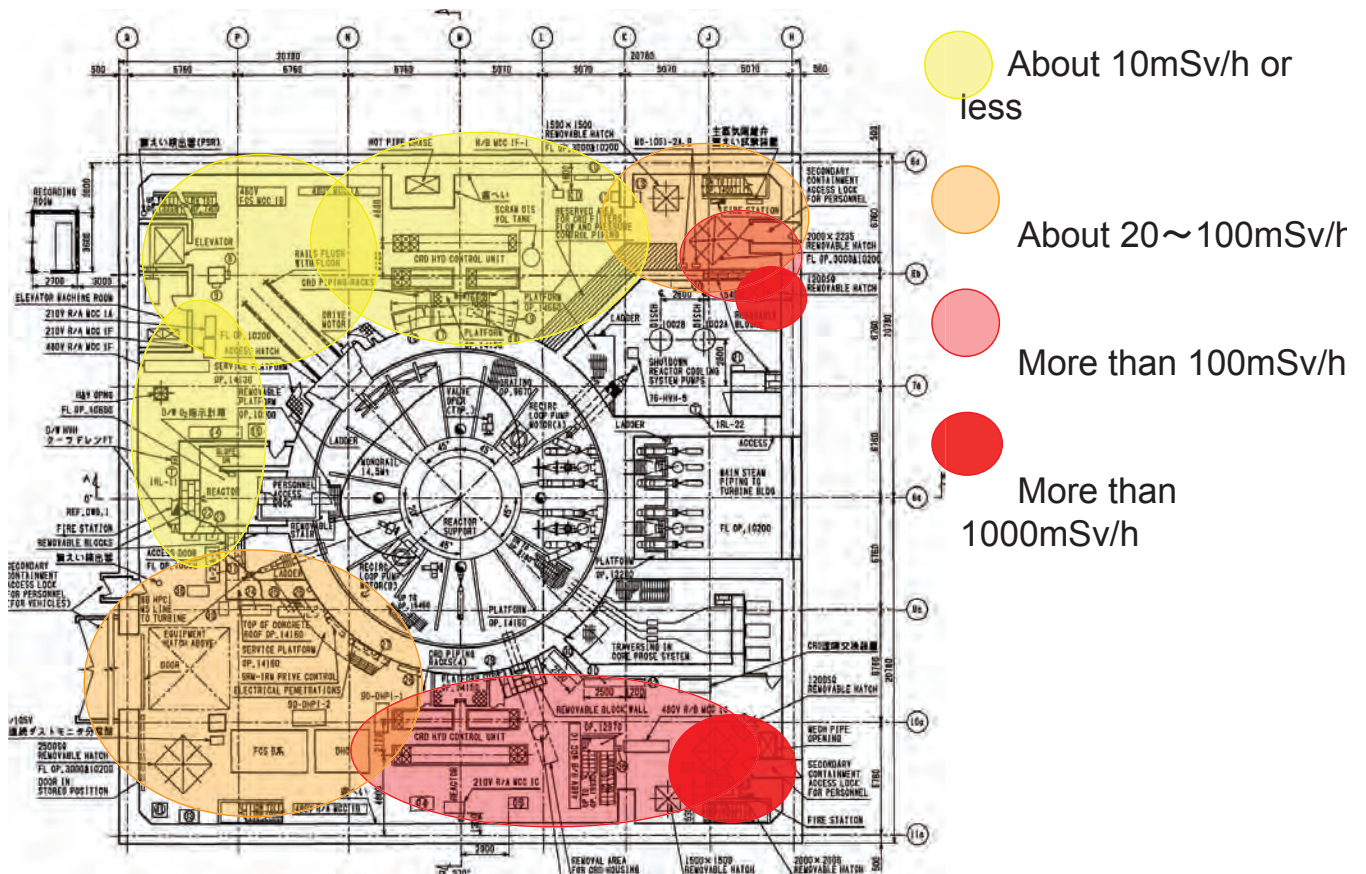

(Figure) Dose Rate Map of 1F-2 1st Floor

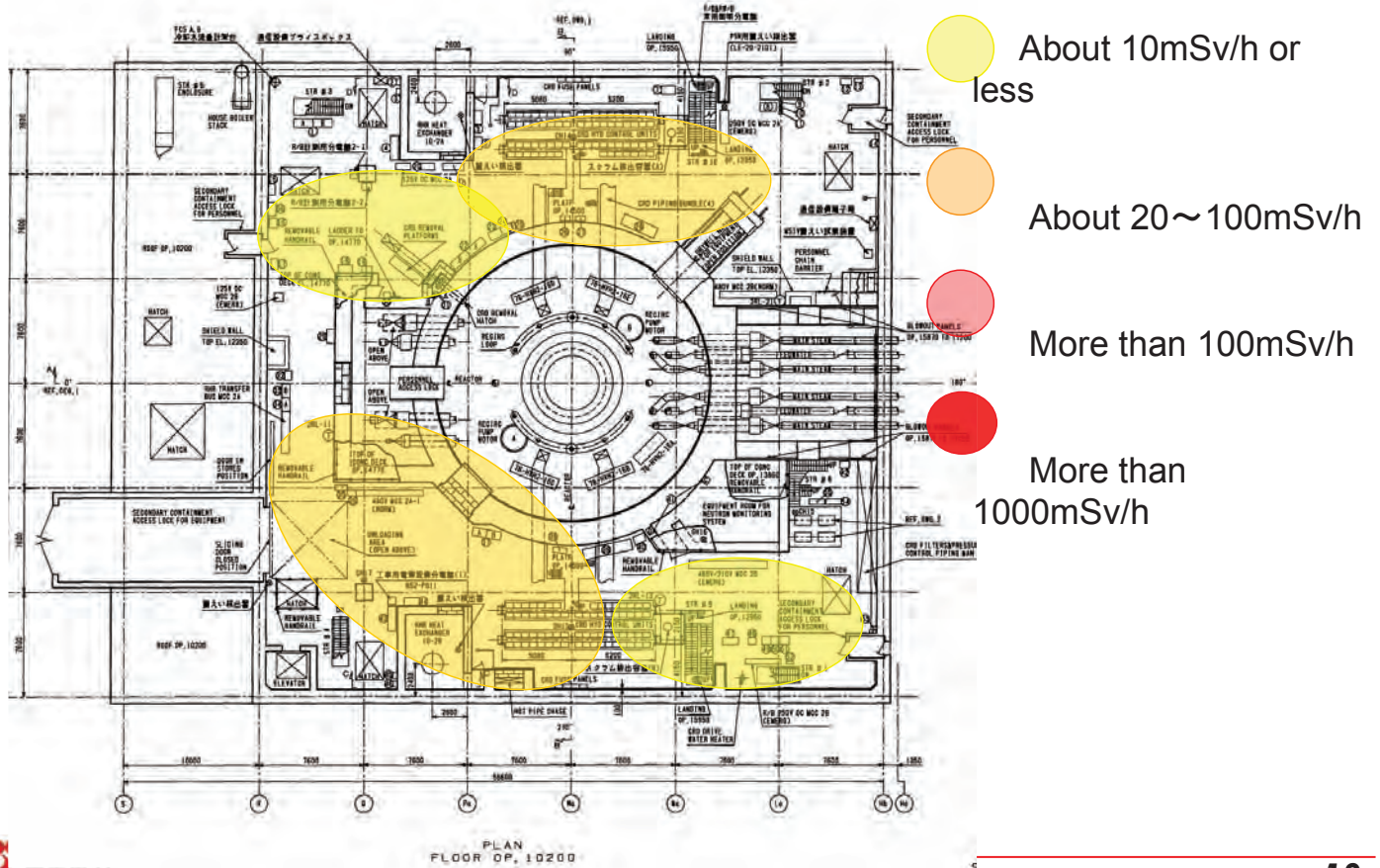

(Figure) Dose Rate Map of 1F-3 1st Floor

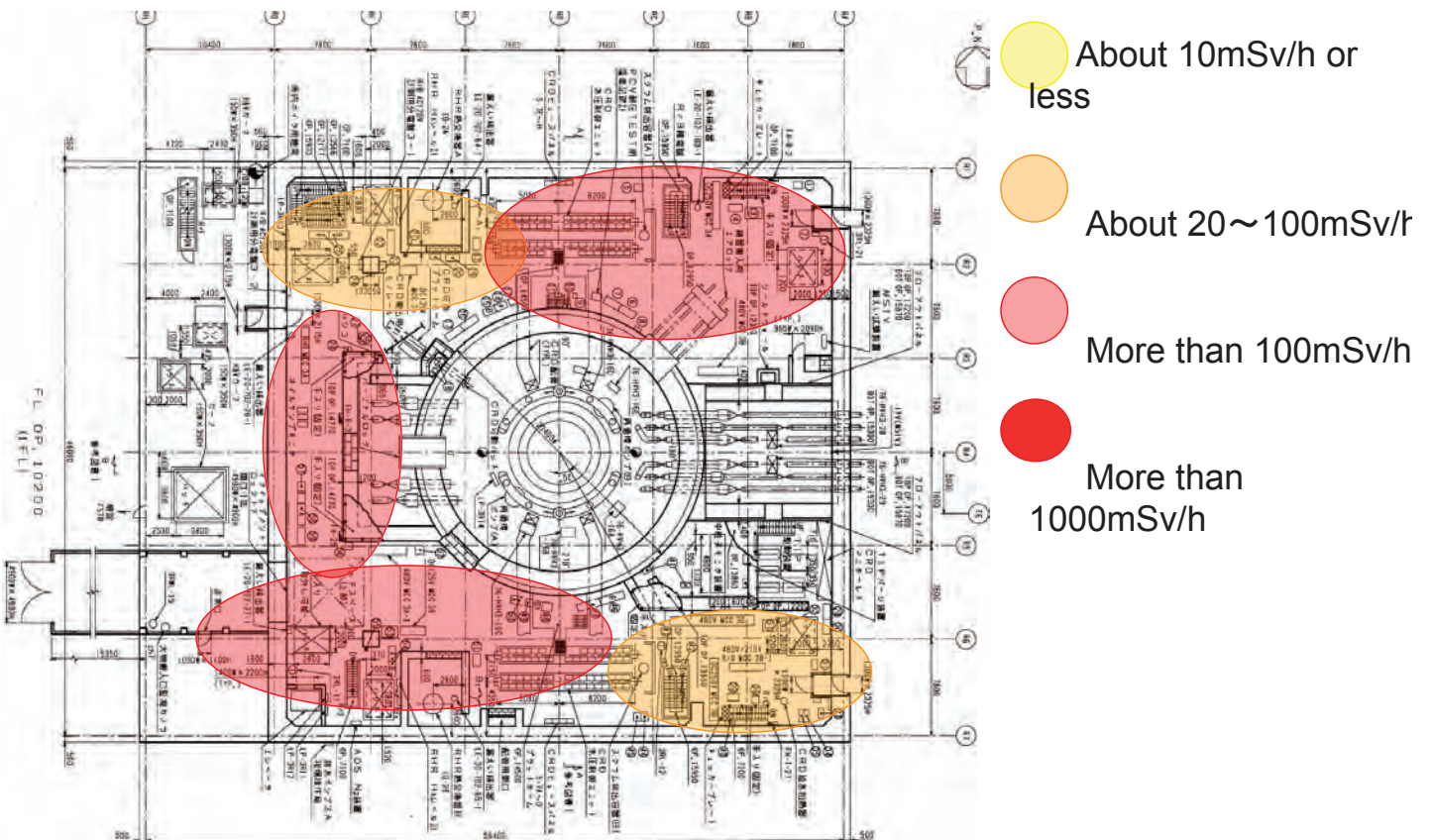

2. Completion of Step 2 - Short term roadmap -

Current Status : Completion of Step 2

Achieved goals of Step 2 of Roadmap Towards Restoration on Dec. 16, 2011.

- ✓ Reactors achieved “cold shutdown condition”
- ✓ Sufficiently low radiation dose at the site boundary can be maintained

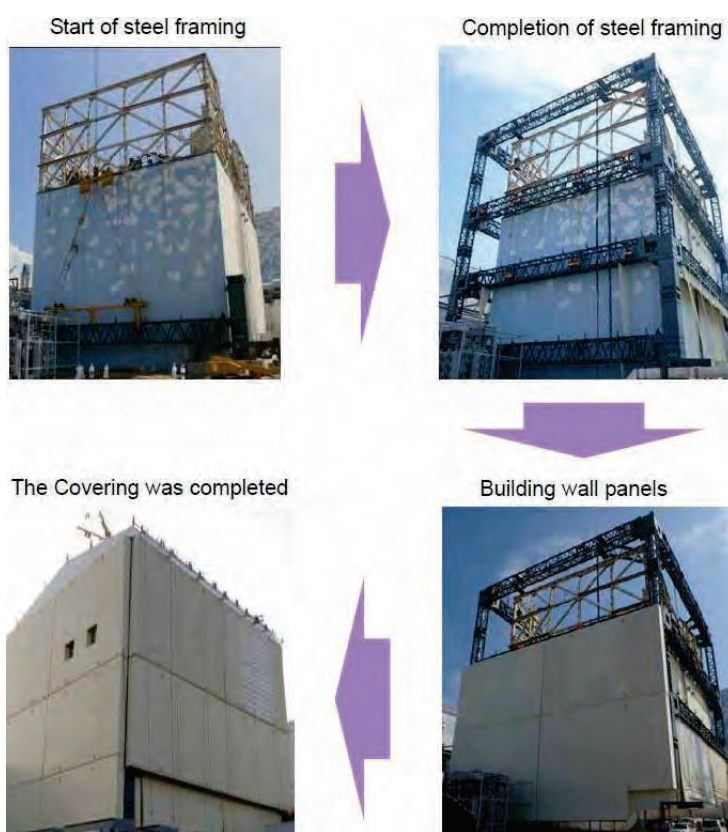

Installation of Unit 1 Reactor Building Cover

[Issue (1) Reactors]:

Achieved “condition equivalent to cold shutdown”.

[Issue (2) Spent fuel pools]:

Achieved “more stable cooling”.

[Issue (3) Accumulated water]:

Total volume of accumulated water has been reduced.

[Issue (4) Groundwater]:

Water shielding wall construction has started.

[Issue (5) Atmosphere/Soil]:

Unit 1 reactor building cover was completed.

[Issue (6) Measurement, Reduction, Announcement]:

Full fledged decontamination work has begun.

[Issue (7) Tsunami, Reinforcement, etc.]:

**Seismic integrity assessment of the reactor buildings has completed.
A support structure at the bottom of the Unit 4 SFP has been installed.**

[Issue (8) Living/working environment]:

**Living/working environment has been improved.
(temporary dormitories and on-site rest stations)**

[Issue (9) Radiation control/Medical care]:

**Health care has been improved.
(restoring appropriate radiation controls)
(organizing a medical care system, etc)**

[Issue (10) Staff training/personnel allocation]:

Continue staff training and continue to maintain strategy to effectively secure human resources

[Action plan for mid-and-long term issues]:

Confirmed the mid-term safety of the circulating cooling system

- “Circulating water cooling” : reuse the contaminated water accumulated in the buildings.
- Release-control / mitigation of radioactive materials from the PCVs
 - ✓ Reactor temperatures stabilized below 100 degrees
 - ✓ PCV internal temperatures stabilized below 100 degrees
 - ✓ Release of radioactive materials from the PCV kept in control

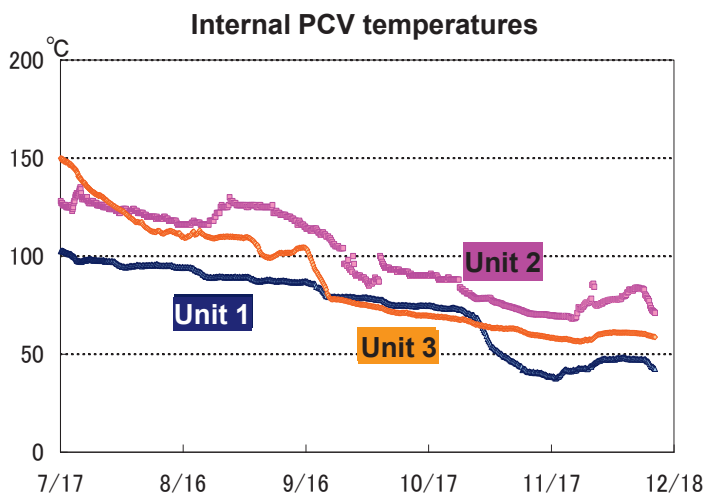
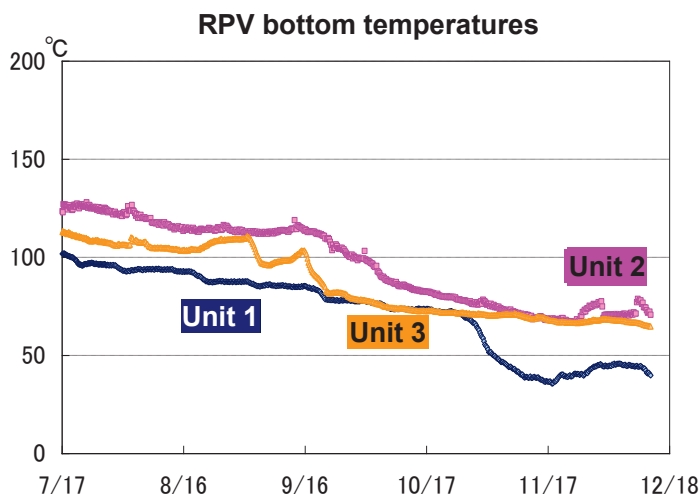

1F-1 Cooling Condition (Steam Generation)

Comparison of the penetration point on the 1st floor



Steam release from the penetration on 1st floor (photo as at Jun. 3)



Situation of the penetration on 1st floor with no steam release (photo as at Oct. 13)

Steam release from the penetration point on the 1st floor was observed on Jun. 3, however no longer confirmed on Oct. 13.



Steam generation has been stopped or so little as to be condensed before leaking into the building, if any. (Therefore inside the PCV should have been cooled.)

1F-2 Cooling Condition (Steam Generation)



Steam release from right above the reactor on 5th floor
(photo as of Sep. 17)



Situation of 5th floor of reactor building with no steam release
(photo as of Oct. 20)

- Steam release was observed on Sep. 17, however no longer confirmed on Oct. 20.
- In addition, the paints of the overhead crane were being stripped off on Oct. 20, which shows that the air is dry (the adhesion of the paints had been weakened via humidity and then the paints were stripped when the air was dried.)

Steam generation has been stopped or so little as to be condensed before leaking into the building, if any.
(Therefore inside the PCV should have been cooled.)

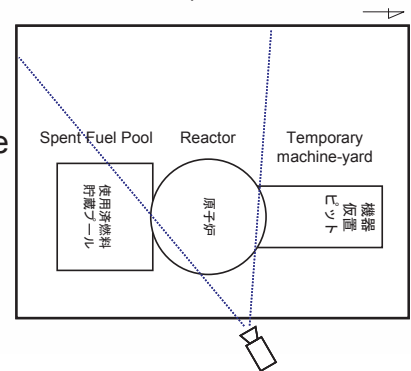

1F-3 Cooling Condition (Steam Generation)

Thermographic monitoring from the sky

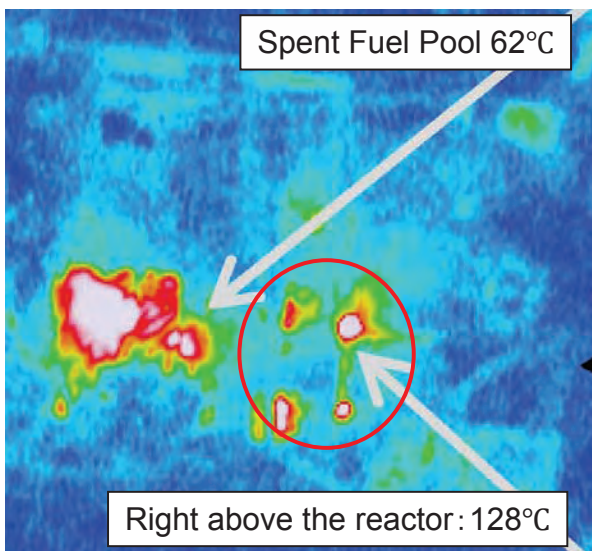

As of Mar. 20 (by Self-Defense Forces)

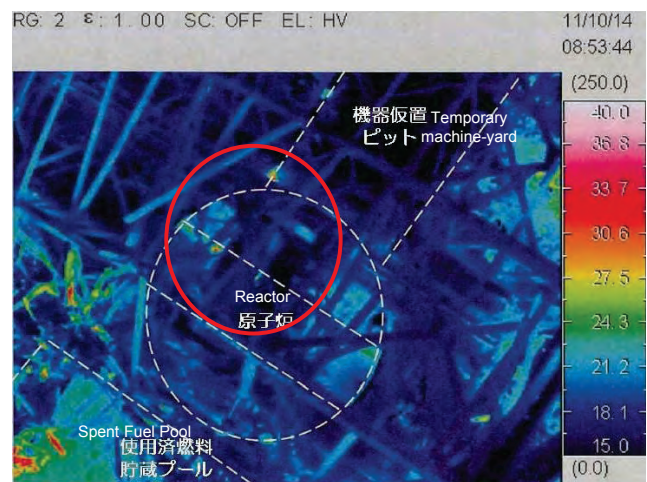

As of Oct. 14

The area of high temperatures as of Oct. 14 is narrowed compared to that as of Mar. 20.

Steam generation has been decreased (the inside of PCV has been cooled.)

- Having installed heat exchangers and maintained pool water level, we achieved “More stable cooling” at all units.
- The desalination facilities for Unit 4 and 2 have been operated. The desalination facility for Units 3 is planned to be installed in turn.



Heat exchanger has been installed (Example of Unit 1)

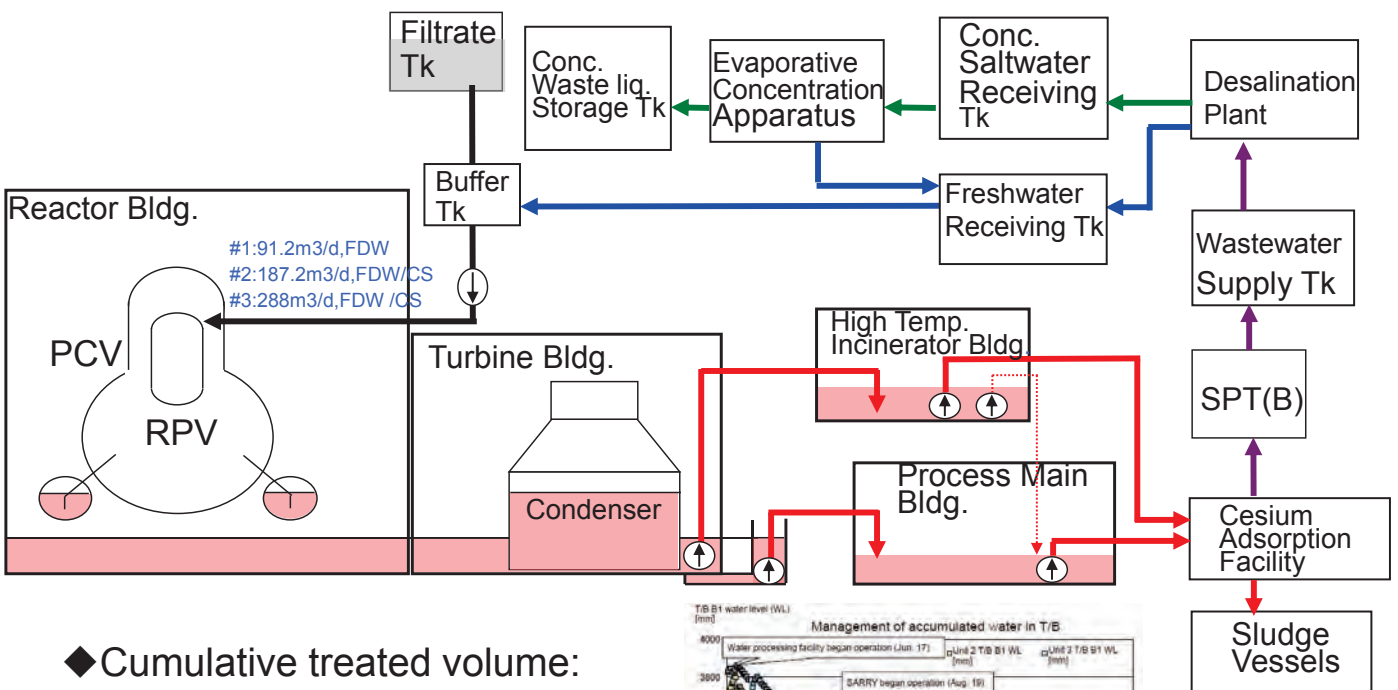
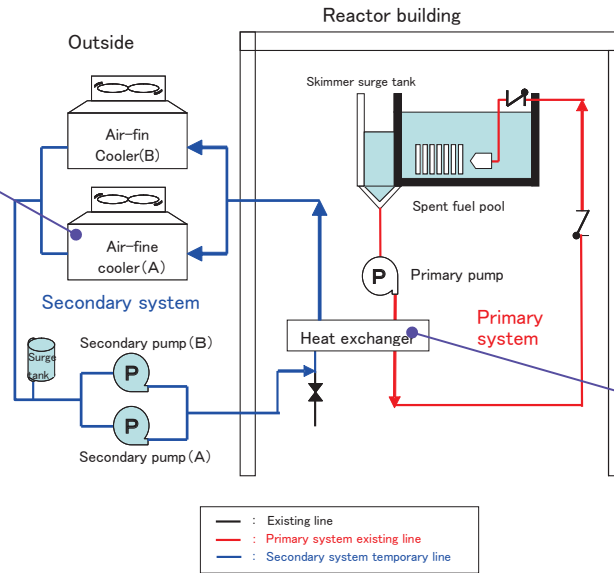

◆ Cumulative treated volume:
 approx. 199,840m³
 (As of Jan.10, 2012)

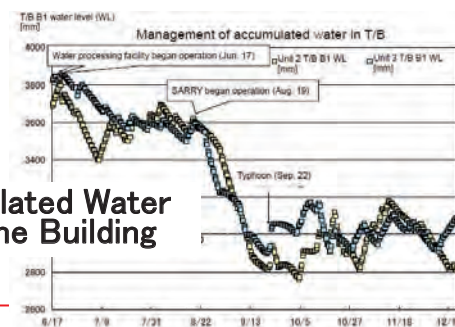

Accumulated Water in Turbine Building

Accumulated Water Treatment



Evaporative concentration apparatus (3A, 3B, 3C)

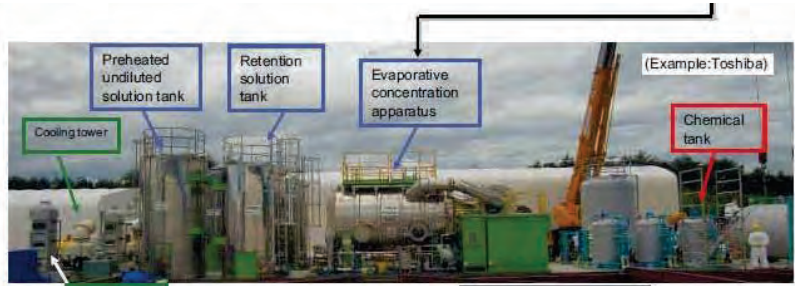

① Installation of cesium adsorption tower



② Cesium adsorption towers

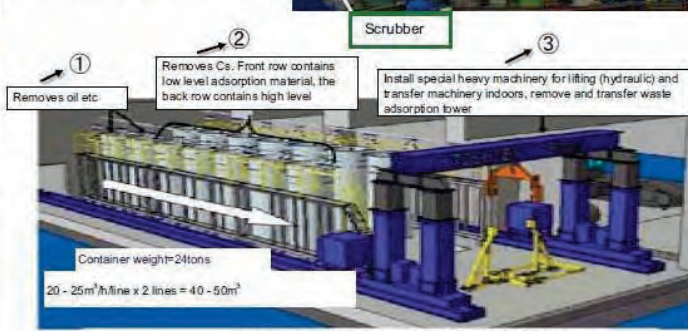

Cesium adsorption apparatus (SARRY)



③ Installation of lifter for changing adsorption towers

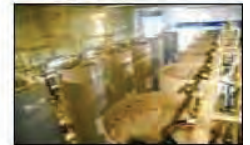

Accumulated Water Treatment Facilities

Contamination removed from accumulated water and reused for reactor cooling.

Reactors

Schematic Diagram of Current Water Supplying System

as of July 7th

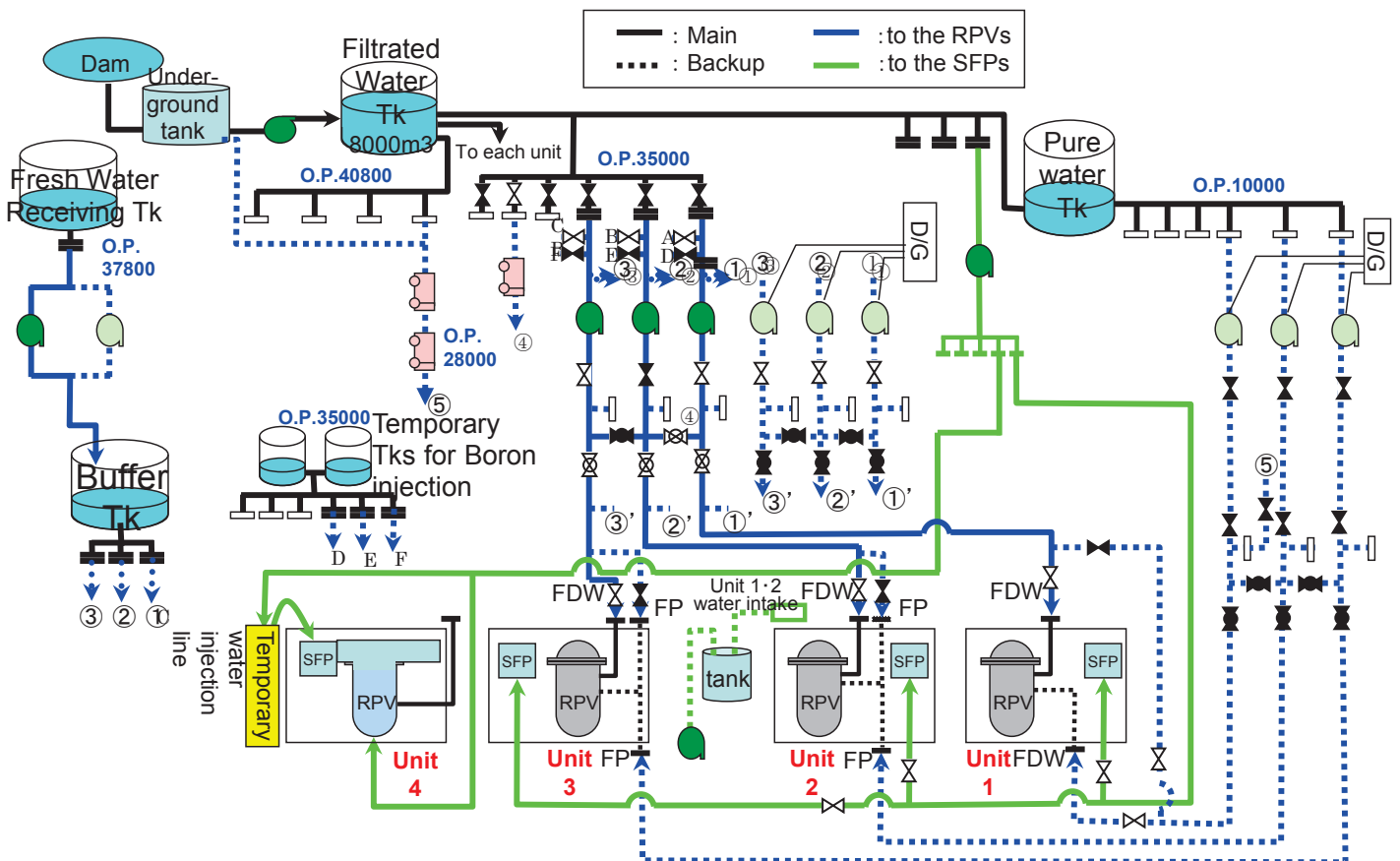

- we implement/start preventative measures to mitigate underground water contamination as well as to halt the spread of contamination into the ocean.
- ✓ Mitigate the leaking of accumulated water in the building
 - > Level of accumulated water is controlled lower than sub drain water level.
- ✓ Start installation of water shielding wall in front of the existing seawall of Unit 1-4.
 - > Prevent contaminated underground water from flowing into the ocean

Overview



Cross-section

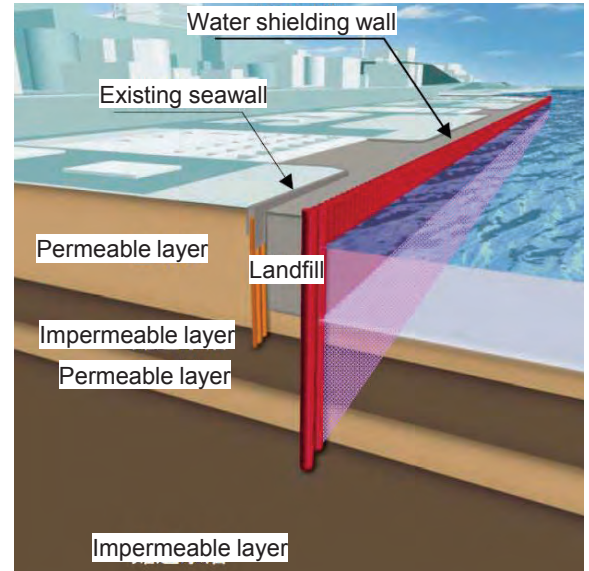
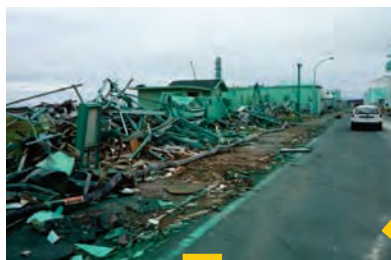

Image of water shielding wall

- Spraying dust inhibitor agents to mitigate spreading of powder dust containing radioactive materials.
- Completed Unit 1 reactor building cover installation (Oct. 28).
- Radiation dose at the site is being held down due to debris removal.
- Completed PCV gas control system.
 - ✓ Started operation of PCV gas control system in Unit 1 (Dec. 15), Unit 2 (Oct. 28) and Unit 3 (Feb.23).



Spraying dust inhibitor agents to the buildings and site ground



Removal of debris



Containers storing debris



Sp

Unit 1 reactor building cover installation



- Monitoring was conducted by the national government, prefecture, municipalities and TEPCO.
- Full-fledged decontamination has been considered and started.

Fiscal Year (Apr. to Mar.)	2011				2012				2013				2014				2015 and after			
	4	7	10	1	4	7	10	1	4	7	10	1	4	7	10	1	4	7	10	1
Decontamination	Monitoring planning				Decontamination, transfer and custody at temporary storage by Local municipalities and the Government												Start transfer into interim storage facility			
					Model Project (especially high radiation area)								Decontamination							

*Extract from "The basic concept of the interim storage facility required in dealing with environmental contamination due to radioactive materials resulting from the accident at Fukushima Daiichi Nuclear Power Plant, TEPCO" (Ministry of the Environment, Oct.29. 2011).

- Via the seismic assessment of all Units' reactor buildings, seismic safety has been confirmed.
- For improving safety margin, support structure has been installed at the bottom of Unit 4 Spent Fuel Pool.
- A temporary tide barrier was installed as a countermeasure against tsunamis. (May 18 ~ Jun. 30)
- Several kinds of countermeasures for radiation shielding were implemented.

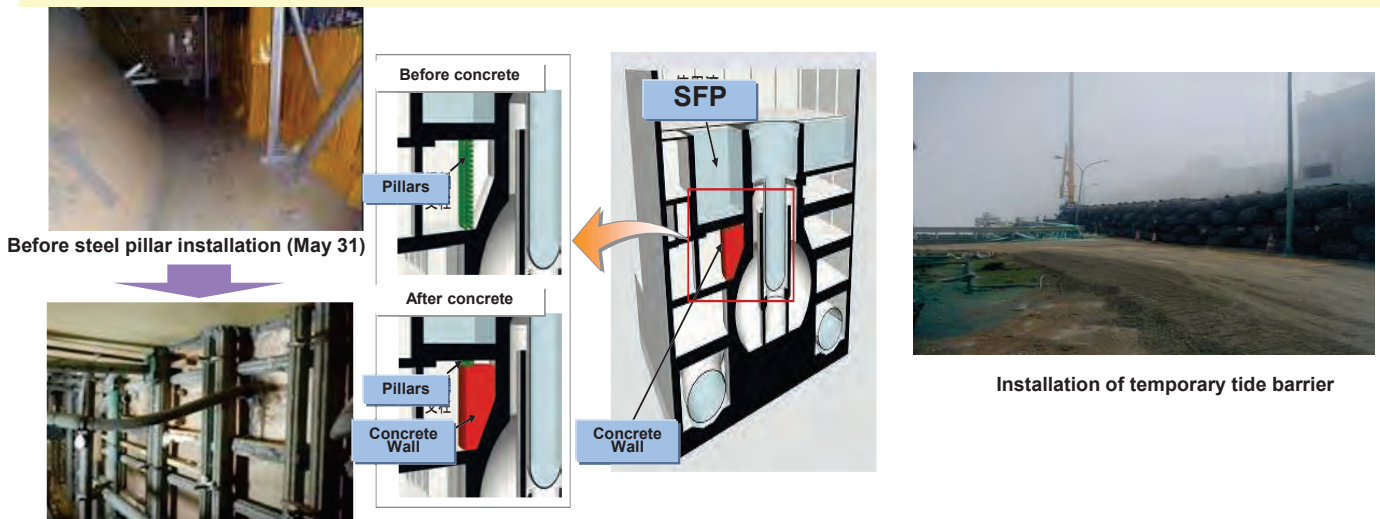

- Rest stations for workers in each area, with water coolers, toilets and air showers.
- Improving the living environment: completed construction of temporary dormitory able to accommodate 1,600 individuals.
- Having improved meals such as providing lunchboxes for lunch and supper from May.



Rest Station

- Improving health care
 - ✓ Conducting additional health checkups every month for those workers whose exposure dose exceeds 100 mSv and who engage in emergency work for over a month.
 - ✓ Routine check ups of recent health conditions and the tracking of the medical history of new site workers
- Increase the number of whole body counters (WBC) and conduct periodical measurements of the internal exposure dose of workers
- Exposure control has been restored and enhanced.
- Medical system improvement continues.



WBC installation

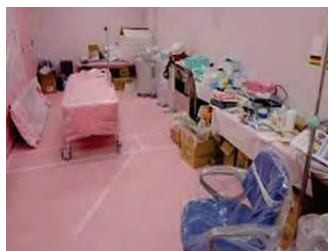

Medical room inside the Main Anti-earthquake building



influenza Vaccination

- Promoting staff training in conjunction with the Government and TEPCO
- Striving hard to secure adequate number of staff





Radiation Survey Staff Training

Introduction of Remote Controlling Machine such as Robots

- Implementing restoration work in consideration of how to utilize remote controlling machines including robots to reduce radiation exposures to workers.
- At the area where high dose is expected, robots carry out visual observation or surveillance of radiation dose or work like cleaning .

<Robots already adopted>

Name	Quince	Warrior	Packbot
Appearance			
Operation	Surveys indoors	Works indoors or outdoors	Surveys indoors or outdoors



Going up stairs in Reactor Building of Unit 3
※operation screen (July 26)



Cleaning in Reactor Building of Unit 3 (July 1)



Surveying high dose area in Turbine Building of Unit 1 (August 2)

3. Mid- and long-term roadmap toward decommissioning

Mid- and long-term Roadmap towards Decommissioning(1/2)

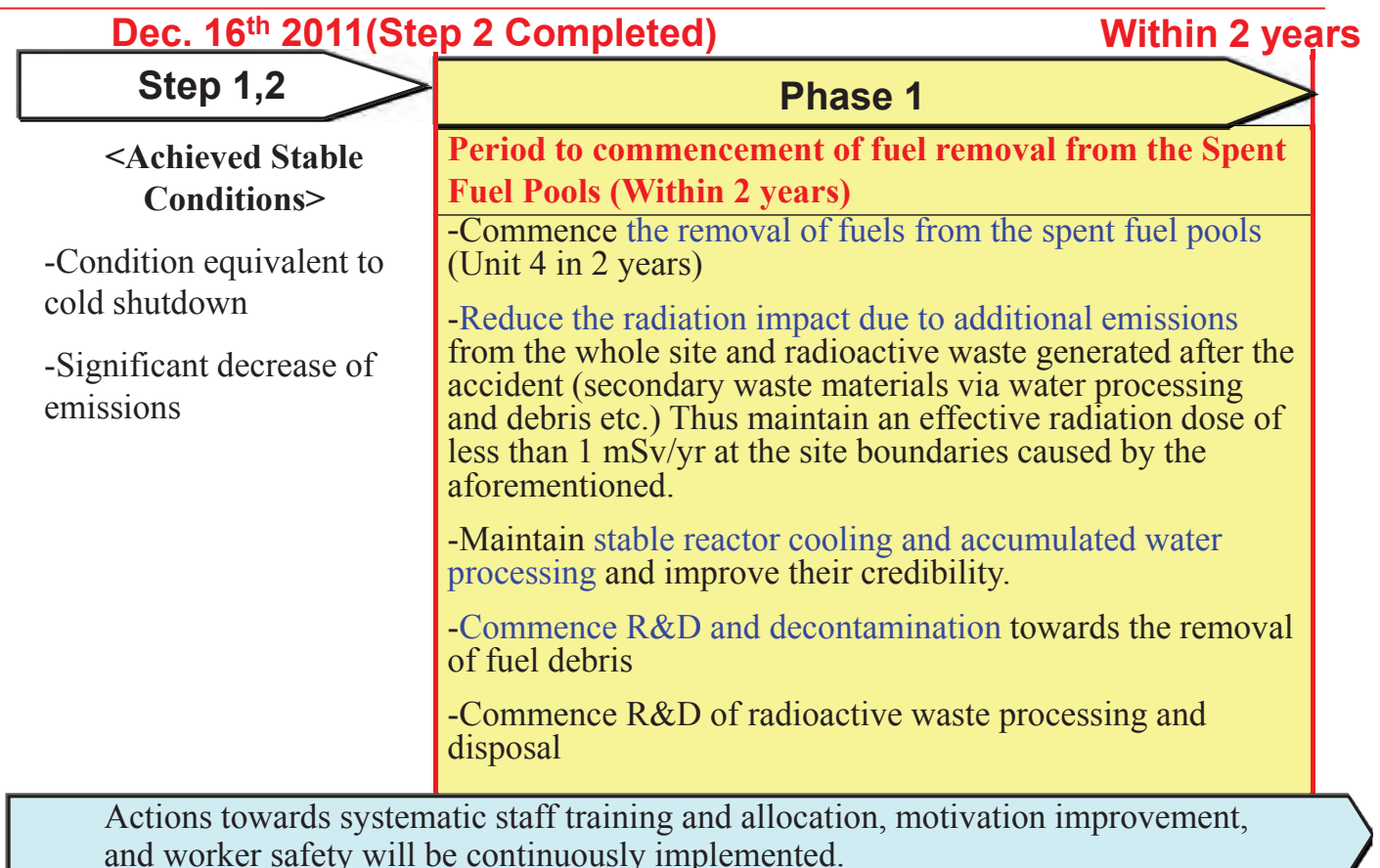

Mid-and long-term Roadmap towards Decommissioning(2/2)

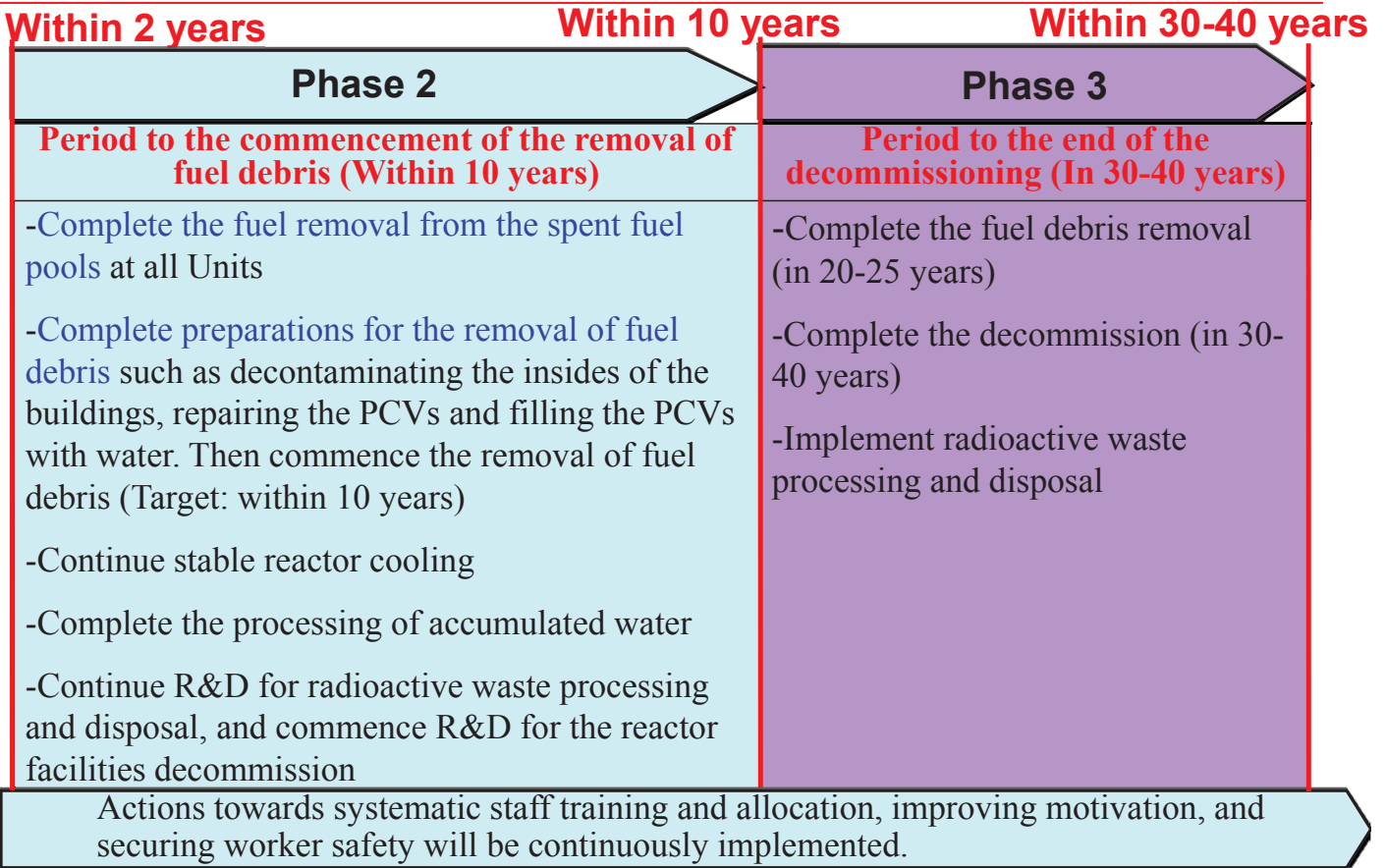

All Rights Reserved ©2012The Tokyo Electric Power Company, Inc.

37

Issue: 1) Reactor Cooling, Accumulated Water Processing

Water injection cooling will be continued up to the completion of the fuel debris removal. system improvements will be continuously implemented. In addition, the water circulation loop will be decreased step-by-step.

By 2012, water decontamination facilities for multi-radioactive nuclides.

During Phase 2, processing of accumulated water in the buildings will be finished when sealing of the water leakage between Turbine and Reactor Buildings, and repairs of the lower parts of PCVs are achieved.

In order to achieve more stable cooling, scaling down of the circulation loop is being considered.

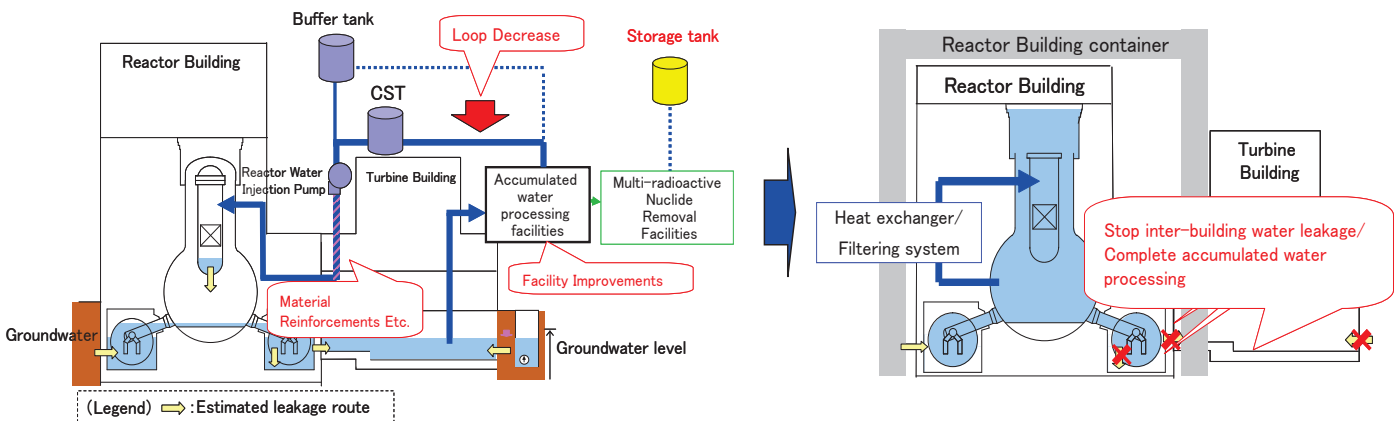

Issue: 2) Mitigation of Sea Water Contamination

Covering and solidifying seabed soil in front of the intake canal.

By the end of FY2012, the continuous operation of the circulating seawater purification facilities

Should underground water be contaminated, water shielding walls will be installed by mid FY2014 in order to prevent underground water from flowing into the ocean.

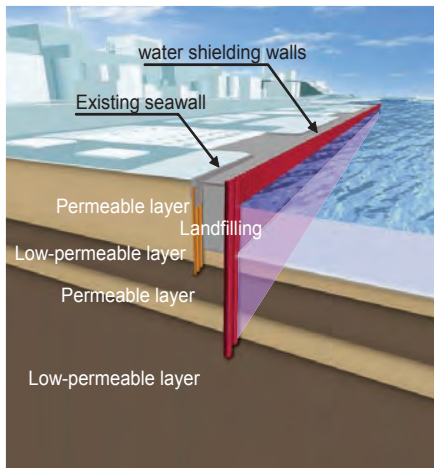

Water Shielding walls (Image)

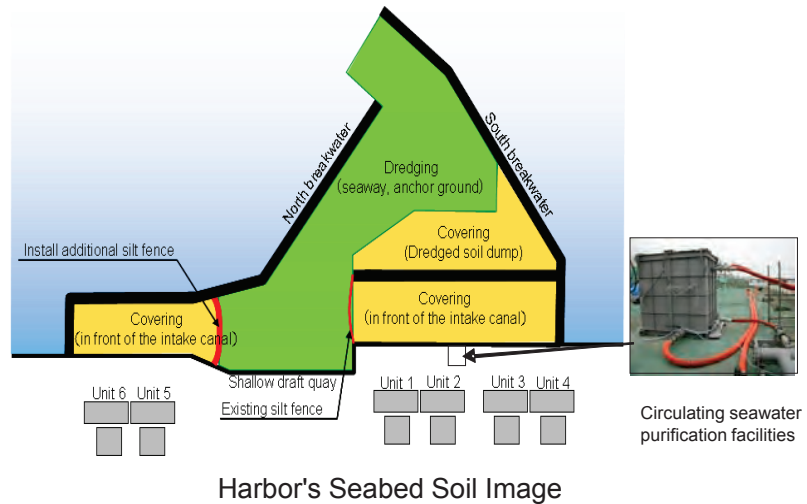

Harbor's Seabed Soil Image

39

Issue: 3) Radioactive Waste Management and Dose Reduction 4) Onsite Decontamination

Reduce effective radiation dose at site boundary due to additional emissions from the site and radioactive waste stored on the site after the accident

Plan to develop a renewal plan by the end of FY2014 for such as containers of secondary waste materials via water processing.

In order to reduce exposure to the public and workers, step-by-step decontamination measures will be implemented

outside of the site.

the Main Anti-Earthquake Building (ERC)

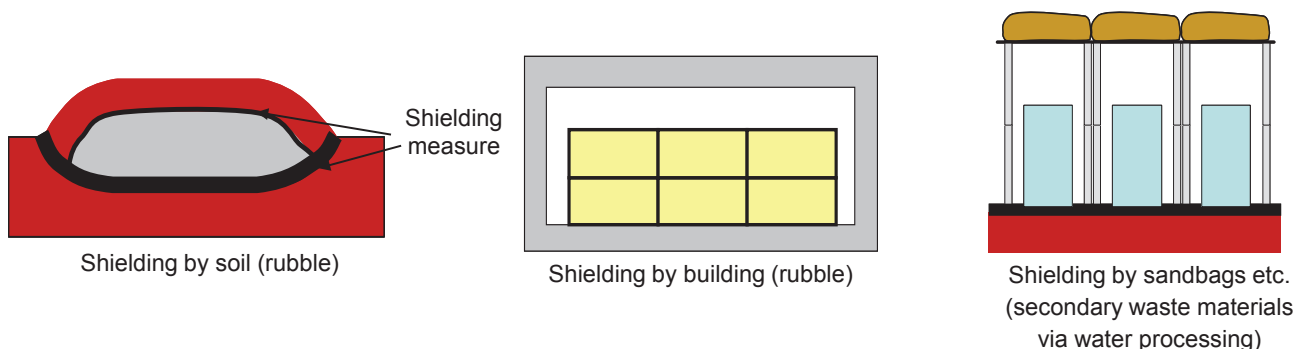

Shielding Measures (example)

40

Issue: 5) Fuels Removal from Spent Fuel Pools

Plan to start fuel removal from Unit 4 within 2 years (by the end of 2013).

Plan to start fuel removal from Unit 3 approximately 3 years later.

As for Unit 1, plan to develop a fuel removal plan based on experiences at Units 3 & 4 and finish fuel removal in the Phase 2.

As for Unit 2, plan to develop a fuel removal plan based on the condition after the decontamination and investigation of existing facilities. Finish fuel removal in the Phase 2.

Plan to determine reprocessing and storing methods for removed fuels during Phase 2.



Debris removal from the upper part of reactor building

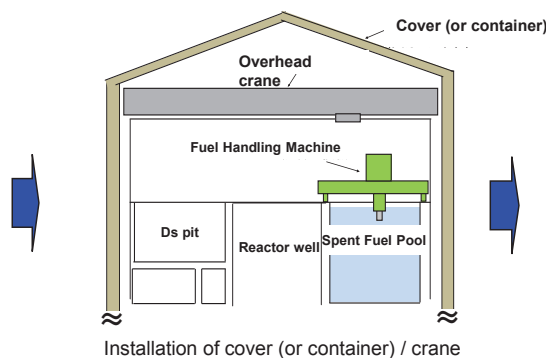

Installation of cover (or container) / crane

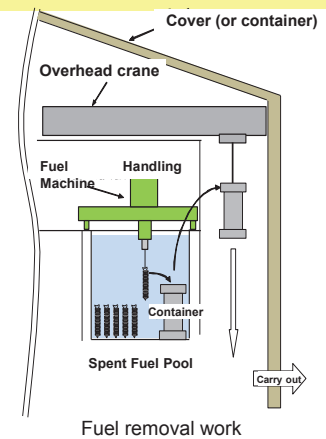

Fuel removal work

41

Issue: 6) Fuel Debris Removal

Plan to start fuel debris removal at any first unit within 10 years.

Removal of fuel debris will be implemented in accordance with the following steps in light of the site situation, safety requirements, and R&D progress of the remote control technologies required in the operations.

- ① Reactor Building Decontamination
- ② PCV Leakage Point Inspections
- ③ Stopping Inter-building Water Leakage PCV Lower Parts Repair
- ④ Filling the Lower Part with Water
- ⑤ Internal PCV Inspection and Sampling
- ⑥ PCV Upper Parts Repair
- ⑦ Filling PCV and RPV with Water ⇒ Open the upper cover on RPV
- ⑧ Internal RPV Inspection and Sampling
- ⑨ Fuel Debris Removal

42

Work Steps Involved in Fuel Debris Removal (1/5)

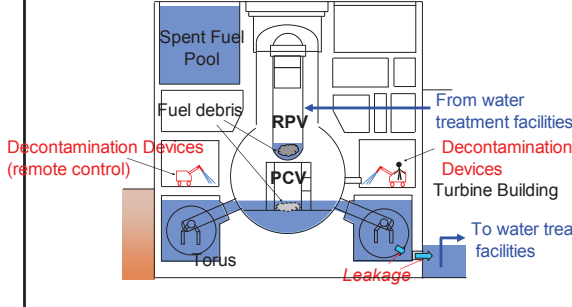
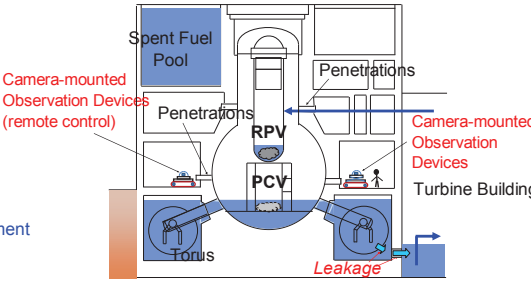
Steps	① Reactor Building Decontamination (Decontaminate each area corresponding to each work following ② sequentially)	② PCV Leakage Point Inspections Inspection from Outside of PCV
<p>Images</p> 		<p>Images</p> 
<p>Contents</p>	<p>In order to easily access PCVs, decontaminate work area via high-pressure washing, coating, and scraping, etc.</p>	<p>Inspect leakage points in the PCV and reactor building via manual or remote dose measurement, and camera, etc. Estimate and inspect the status of PCV inside via measurement of gamma ray from outside of PCV, and acoustic inspection, etc.</p>
<p>Points to Note on Development</p>	<ul style="list-style-type: none"> ◆ The existence of areas of high dosage (several hundred to 1,000 mSv/h). ◆ Access restriction due to rubble scattered about inside R/B. • Remote decontamination methods corresponding to the above need to be considered and established. 	<ul style="list-style-type: none"> ◆ Inspection areas may be located in highly radioactive environments, under contaminated water, and in narrow space. • Develop leakage point inspection methods and devices. • Develop methods and devices for internal inspection from outside of PCV.
<p>Points to Note on Ensuring Safety</p>	<ul style="list-style-type: none"> • Maintain RPV cooling in a stable state • Prevent radioactive materials scattering during decontamination • Reduce workers' exposure (remote control, shielding, etc.) 	<ul style="list-style-type: none"> • Maintain RPV cooling in a stable state • Reduce workers' exposure (remote control, shielding, etc.)

Work Steps Involved in Fuel Debris Removal (2/5)

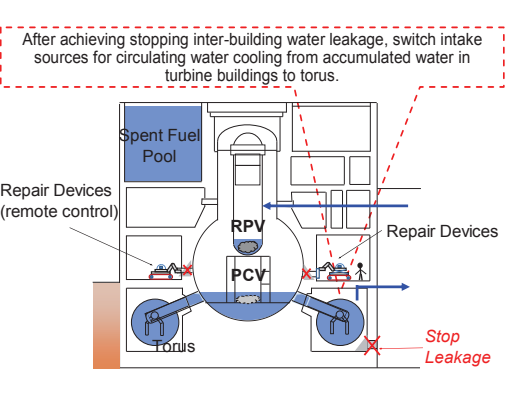
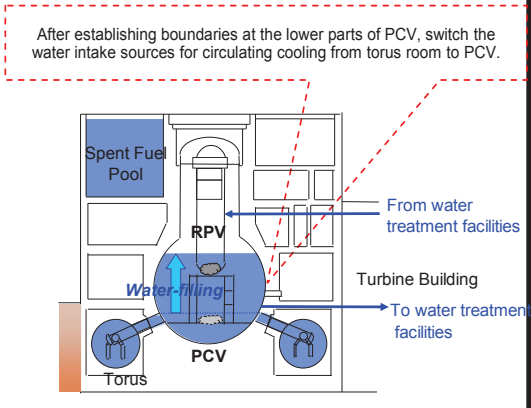
Steps	③ Stopping Inter-building Water Leakage PCV Lower Parts Repair	④ Filling the Lower Part with Water
<p>Images</p> 		<p>Images</p> 
<p>Contents</p>	<p>Repair PCV leakage points and then stop water leakage because it is believed that removing debris while underwater with the radiation shielding advantage will be a reliable method. First, repair points at lower parts of PCV for internal inspection.</p>	<p>Partially fill the lower parts of PCV with water before starting PCV internal inspection.</p>
<p>Points to Note on Development</p>	<ul style="list-style-type: none"> ◆ While continuing water injection for circulating water cooling, stop water leakage under highly radioactive and water flowing conditions. • Develop technologies and methods to repair leakage points and stop water leakage. • Consider and develop alternatives. 	<ul style="list-style-type: none"> ◆ Same as ③ • Place top priority on establishing boundaries at the lower parts of PCV (including filling torus room with grout materials).
<p>Points to Note on Ensuring Safety</p>	<ul style="list-style-type: none"> • Maintain RPV cooling in a stable state • Reduce workers' exposure (remote control, shielding, etc.) 	<ul style="list-style-type: none"> • Maintain RPV cooling in a stable state • Subcritical assessment

Work Steps Involved in Fuel Debris Removal (3/5)

Steps	⑤ Internal PCV Inspection and Sampling	⑥ PCV Upper Parts Repair
Images		
Contents	Ascertain distributions of fuel debris flowed from RPV by internal PCV inspections and samplings etc.	In order to fill the PCV full with water, repair leakage points at the upper parts of PCV by manual or remote methods.
Points to Note on Development	<p>◆ Access restriction due to high radioactive conditions and unknowing PCV internal conditions (clearness of internal water, existence of debris, etc.)</p> <ul style="list-style-type: none"> Develop remote inspection methods and sampling methods corresponding to the above. 	<p>◆ Same as ②</p> <ul style="list-style-type: none"> Develop technologies and methods to repair PCV leakage points and stop water leakage (same as ③).
Points to Note on Ensuring Safety	<ul style="list-style-type: none"> Maintain RPV cooling in a stable state Subcritical assessment Prevent radioactive substances release from PCVs Reduce workers' exposure (remote control, shielding, etc.) 	<ul style="list-style-type: none"> Maintain RPV cooling in a stable state Reduce workers' exposure (remote control, shielding, etc.)

45

Work Steps Involved in Fuel Debris Removal (4/5)

Steps	⑦ Filling PCV and RPV with Water ⇒ Open the upper cover on RPV	⑧ Internal RPV Inspection and Sampling
Images		
Contents	After filling PCV/RPV with enough water to ensure shielding, open the upper cover on RPV.	Ascertain conditions of fuel debris and internal RPV structures by internal RPV inspections and samplings etc.
Points to Note on Development	(Place top priority on establishing PCV boundaries as per ⑥)	<p>◆ Restricted access route due to high radioactive conditions and unknown internal RPV conditions (clearness of internal water, existence of debris, etc.)</p> <ul style="list-style-type: none"> Develop remote inspection methods and sampling methods based on the above.
Points to Note on Ensuring Safety	<ul style="list-style-type: none"> Maintain RPV cooling in a stable state Subcritical assessment Prevent radioactive substances release from PCVs 	<ul style="list-style-type: none"> Maintain RPV cooling in a stable state Subcritical assessment Store the removed fuel debris (containment etc.) Reduce workers' exposure (remote control, shielding, etc.)

46

Work Steps Involved in Fuel Debris Removal (5/5)

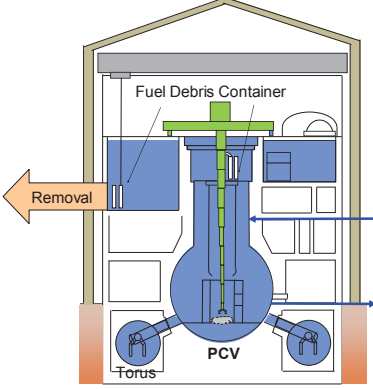
Steps	⑨ Fuel Debris Removal
Images	
Contents	Remove debris inside RPV and PCV
Points to Note on Development	<p>◆ Expand technology development scope depending on distribution status of fuel debris (No experience of fuel removal of inside PCV at TMI)</p> <ul style="list-style-type: none"> • Develop more sophisticated technologies and methods than those of TMI
Points to Note on Ensuring Safety	<ul style="list-style-type: none"> • Maintain RPV cooling in a stable state • Subcritical assessment • Store the removed fuel debris (containment etc.) • Reduce workers' exposure (remote control, shielding, etc.)

47

Issue: 7) Reactor Facilities Demolition

8) Radioactive Waste Processing and Disposal

Plan to complete the reactor facilities demolition of Units 1 to 4 within 30 to 40 years after the completion of Step 2.

Plan to determine waste form specifications, after confirmation of safety and applicability to the existing disposal concept.

Plan to commence treatment and disposal during Phase 3, after development of disposal facilities and preparation of a prospective disposal plan.

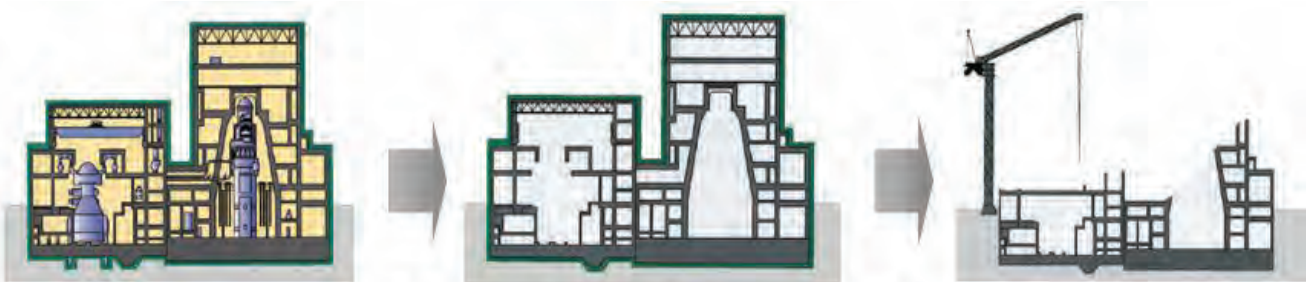

Nuclear Reactor Facilities Demolition (Image)

48

Image of Main R&D Issues related to Fuel Debris Removal(1/3)

Remote decontamination of reactor building interior

Overview

Improvement of work environment for surveying and repairing leak areas, etc.

-> Remote decontamination devices that match onsite contamination conditions

Technical development issues

- Assessment and development of effective decontamination technologies in response to contamination type
- Development of remote decontamination devices for severe environments, such as high-dose areas, narrow spaces, etc.

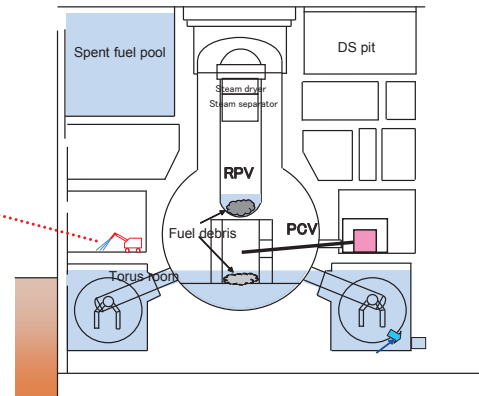
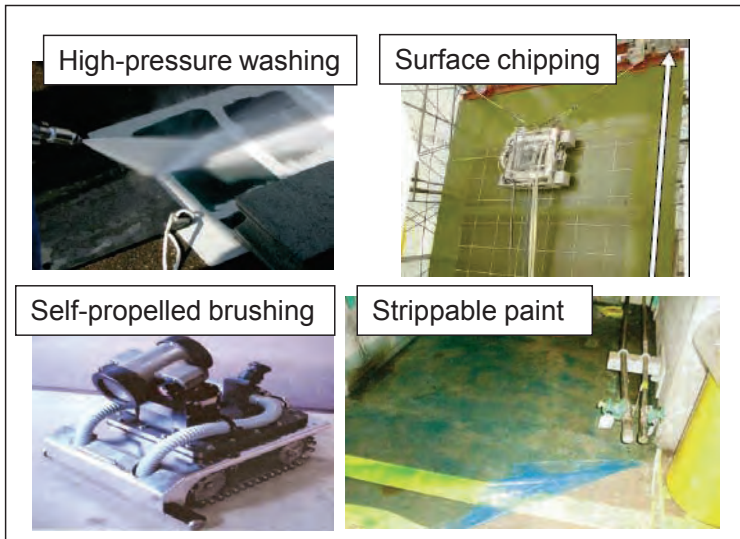

Decontamination technologies (examples)

49

Image of Main R&D Issues related to Fuel Debris Removal (2/3)

Technologies for investigation of the PCV interior

Overview

Need to grasp conditions and the state of fuel debris inside the PCV

-> Remote investigation methods and devices

Technical development issues

- Development of remote investigation technologies for high-temperature, high-humidity, and high-dose environments
- Development of a system to prevent the dispersal of radioactive materials

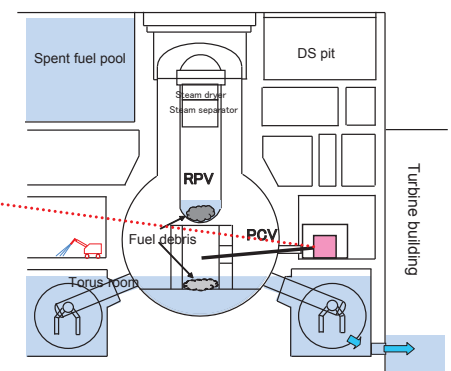
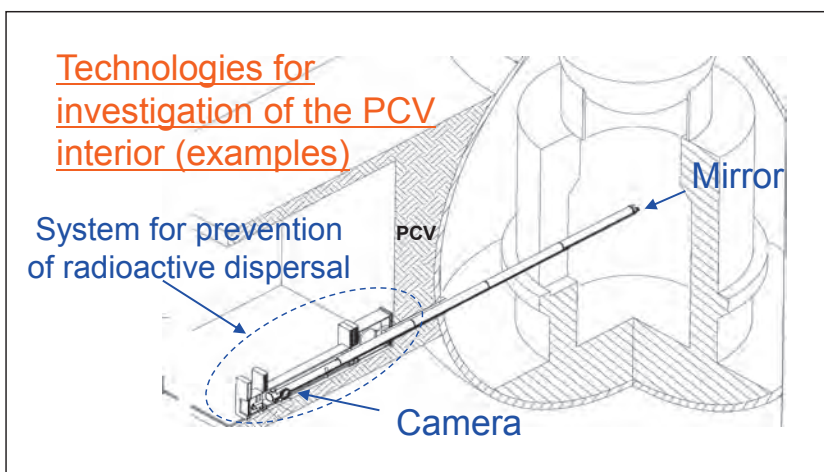

50

Image of Main R&D Issues related to Fuel Debris Removal (3/3)

Technologies for identification of leak areas of PCV

Overview

Remote identification of leak areas in the PCV, etc.

Technical development issue

- Development of remote survey technologies under severe environments, such as high-dose areas, narrow spaces.

PCV Repair Technologies

Overview

Need to repair and stop leaks in leaking areas (Torus room, PCV, etc.).

-> Remote measures and technologies

Technical development issues

- Development of remote repair technologies for severe environments, such as high-dose areas, narrow spaces, etc.
- Repair technologies applicable to underwater environments (lower part of the PCV, etc.)

Envisioned damage areas (examples)

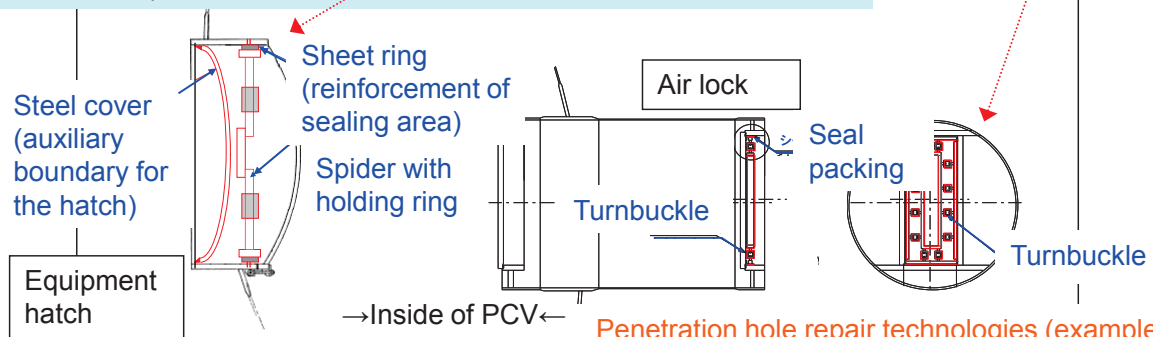
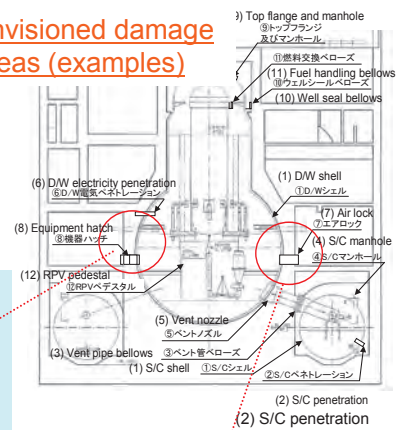

Penetration hole repair technologies (examples) 51

Image of R&D - Processing and Disposal of Radioactive Waste (1/4)

1. Properties investigation

Investigation issues

- Properties differ from conventional waste, such as rubble, sludge, and decontaminated waste liquid (nuclide composition, chloride content, etc.)
- Basic information needs to be assessed for development of each technologies

Examples of differences with conventional waste

- Main nuclides: Co-60, C-14, etc.
 - 1F: Cs-137, Sr-90, etc.
- Sodium concentration is 5 times that of the TMI case due to 50-90% contamination by seawater
 - Lower Cesium absorption performance, increased waste generation
- Presence of sludge and other materials of unknown chemical composition
 - Need to identify these materials through analysis



Outputs

- Radioactive concentration of each type of nuclide
- Component content
- Physicochemical characteristics etc.

The installation of a hot lab near 1F must also be considered, as large volumes of high-dose, untransportable samples are expected to be generated as a result of decontamination and fuel debris removal.

New technologies need to be developed for radioactive waste that are difficult to treat with existing technologies, including a new disposal concept.

Image of R&D - Processing and Disposal of Radioactive Waste (2/4)

2. Long-term storage technologies

Technical development issues

- Impact of chloride (corrosion) and high radioactivity (heat generation, hydrogen, surface radiation)
- Term of storage: how long should it be?
- Is treatment necessary before storage?

Stabilized storage is necessary until processing/disposal technologies are established.



Current facility for secondary waste storage after water treatment

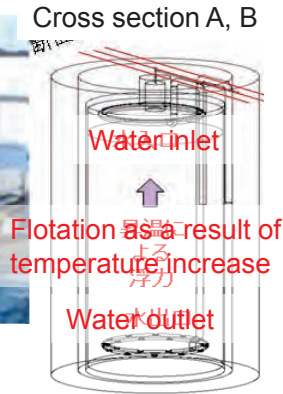

A-A cross section
Temperature distribution

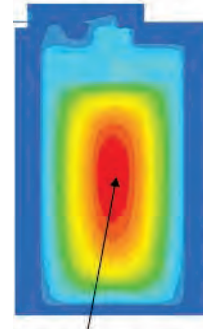

Temperature of zeolite layer
Approx. 170°C max.

B-B cross section
Hydrogen density distribution

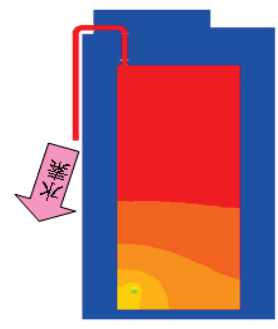

Output

- Long-term storage design for each type of waste

Evaluation of temperature and hydrogen distribution in a KURION absorption vessel (by JAEA)

53

Image of R&D - Processing and Disposal of Radioactive Waste (3/4)

3. Processing technologies

Technical development issues

- Applicability of existing technologies (including pre-processing / solidification)

Processing means that waste is packed into the vessel and solidified (cementation, etc.), so that it can be buried at the disposal site.

Examples of waste package

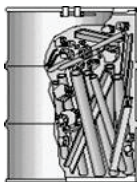

Drums



Square vessels

Examples of solidification

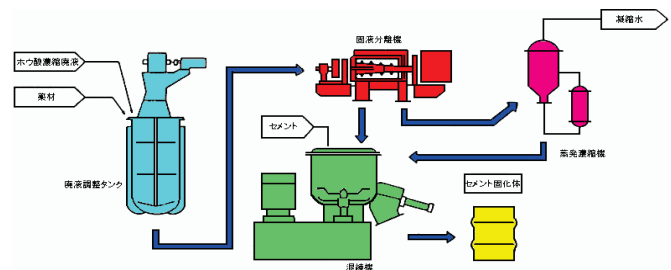

Basic flow in a cementing facility

Source: Japan Atomic Industrial Forum Inc. (ed.), *Radioactive Waste Management: Technical Development and Plans in Japan*, July 1997, p.81.

Outputs

- Treatment methods for storage
- Methods for production of waste packages
- Performance of waste packages

54

4. Disposal technologies

Technical development issues

- Applicability of existing disposal concept
- Extract and address issues related to safety evaluation and find a solution

Existing concept

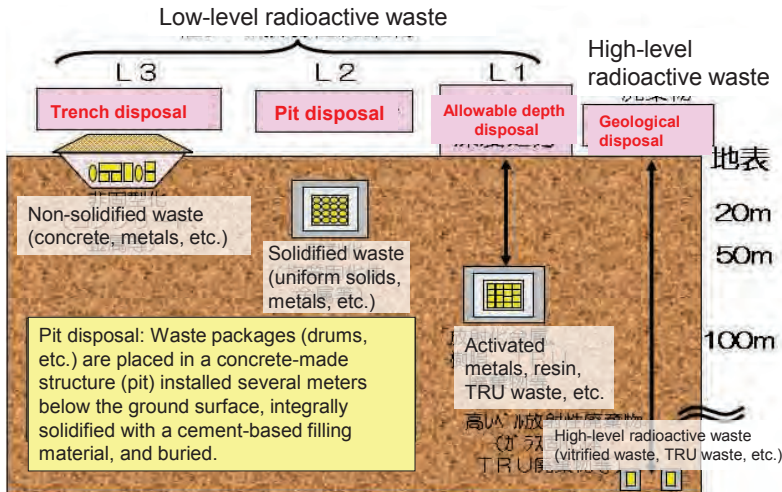

Example of an engineered barrier (Yoyusindo disposal)

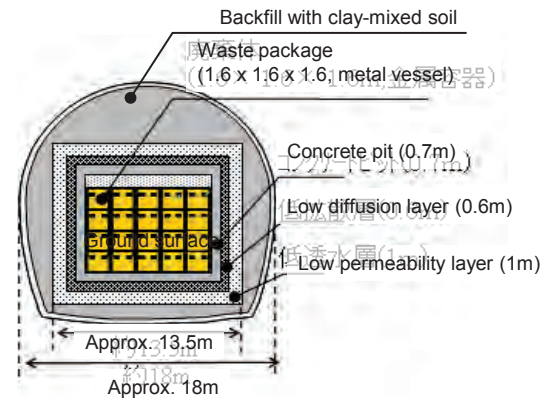

Output

- Waste disposal methods (required burial depth, construction of an engineered barrier, etc.)

4. Lessons learned and countermeasures

Lessons Learned and Countermeasures

➤ **Thorough equipment protection measures against tsunami to prevent power loss and loss of the heat removal function are important.**

- ◆ Preventing the flooding of buildings
 - ✓ Embankment
 - ✓ Flood Barriers & Walls
- ◆ Preventing the flooding of important equipment
 - ✓ Water-tight doors in R/B etc.

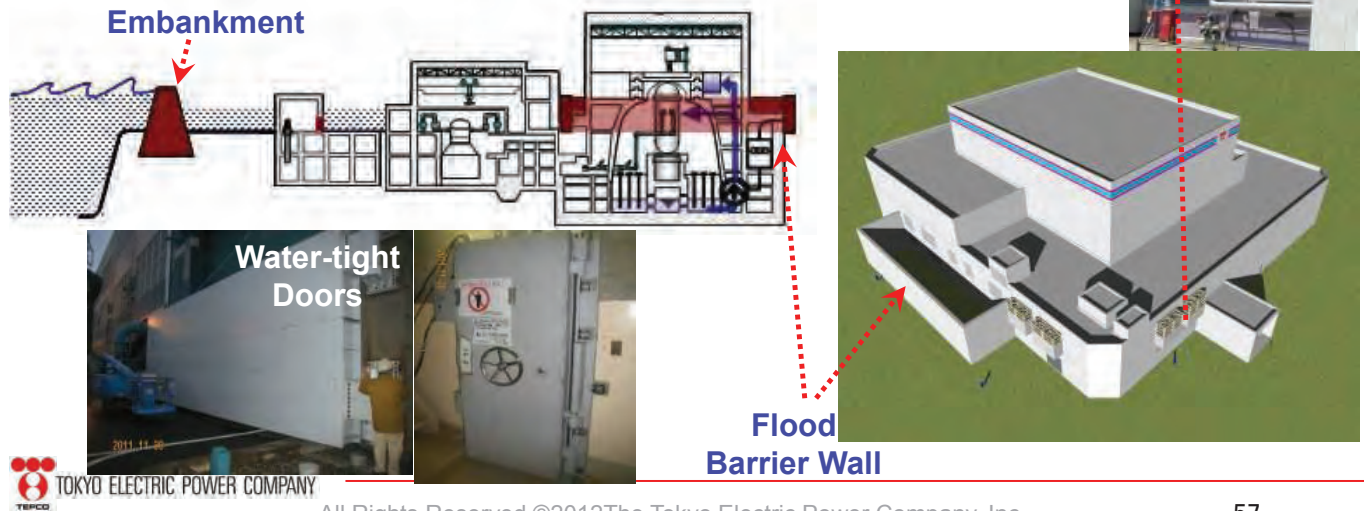

All Rights Reserved ©2012The Tokyo Electric Power Company, Inc.

57

Lessons Learned and Countermeasures

➤ **Regardless of the initial cause of the accident, flexible alternative measures with improved applications and mobility to prevent core damage against “long lasting simultaneous loss of AC and DC power” and “long lasting loss of heat removal function” are important.**

- ◆ Enhancing high-pressure & low-pressure cooling water injection
 - ✓ Manual startup of steam-driven cooling water injection equipment
 - ✓ Preparation of mobile power trucks and backup water source
 - ✓ Establishment of water injection means using fire engines
- ◆ Enhancing reactor depressurization
 - ✓ Preparation of spare batteries and gas cylinders
- ◆ Enhancing heat removal and cooling
 - ✓ Backup AC power
 - ✓ Preparation of spare replacement motor for emergency sea water systems
 - ✓ Preparation of a portable mobile heat exchanger (pump, heat exchanger set)
- ◆ Securing power for monitoring instruments



Mobile power trucks

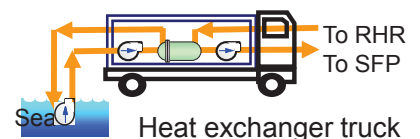

Heat exchanger truck

Lessons Learned and Countermeasures

- From the perspective of defense-in-depth, it is important to take **further measures in case core damage does occur.**

- ◆ Preventing hydrogen accumulation in R/B
 - ✓ Opening holes on the roof of R/B (top vent) etc.
- ◆ Suppressing the release of radioactive materials
 - ✓ Preparation for water injection to the PCV through tire engines, etc
 - ✓ Backup AC power and modification of design to facilitate PCV venting

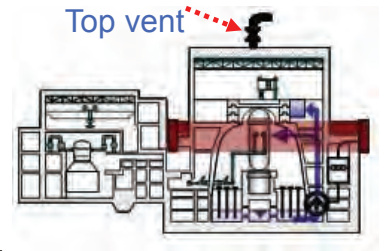

- It is important to prepare **further equipment and auxiliary facilities for support of on-site response.**

- ◆ Debris removal equipment
- ◆ Communication methods
- ◆ Lighting equipment
- ◆ Protective equipment (protective wears, masks, APDs etc.)



Lessons Learned and Countermeasures

- Without **newly built Emergency Response Center**, the post-accident activities could not have been carried out.

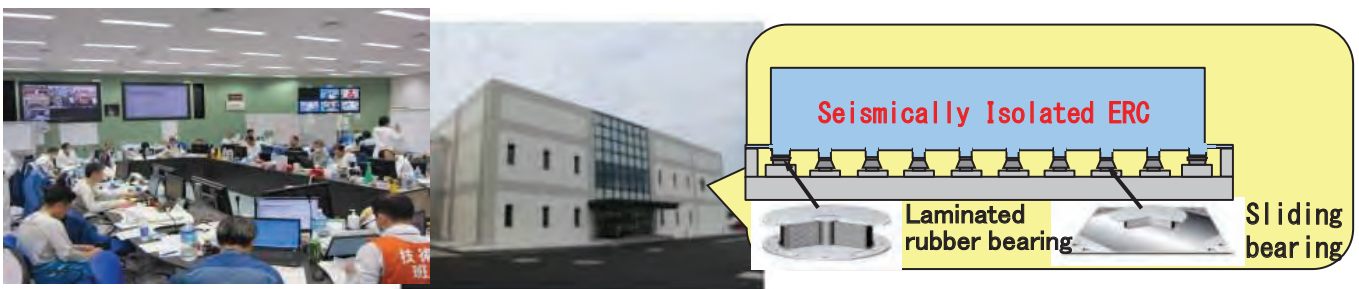

- ◆ Measures taken after Niigata Chuetsu Oki Earthquake were effective:
 - ✓ Emergency response center in robust building (Seismic isolation, Shielding, Communication, etc.)
 - ✓ Underground water tank and Fire Engines (3/site)



Immediate Safety Measures at Kashiwazaki-Kariwa NPS

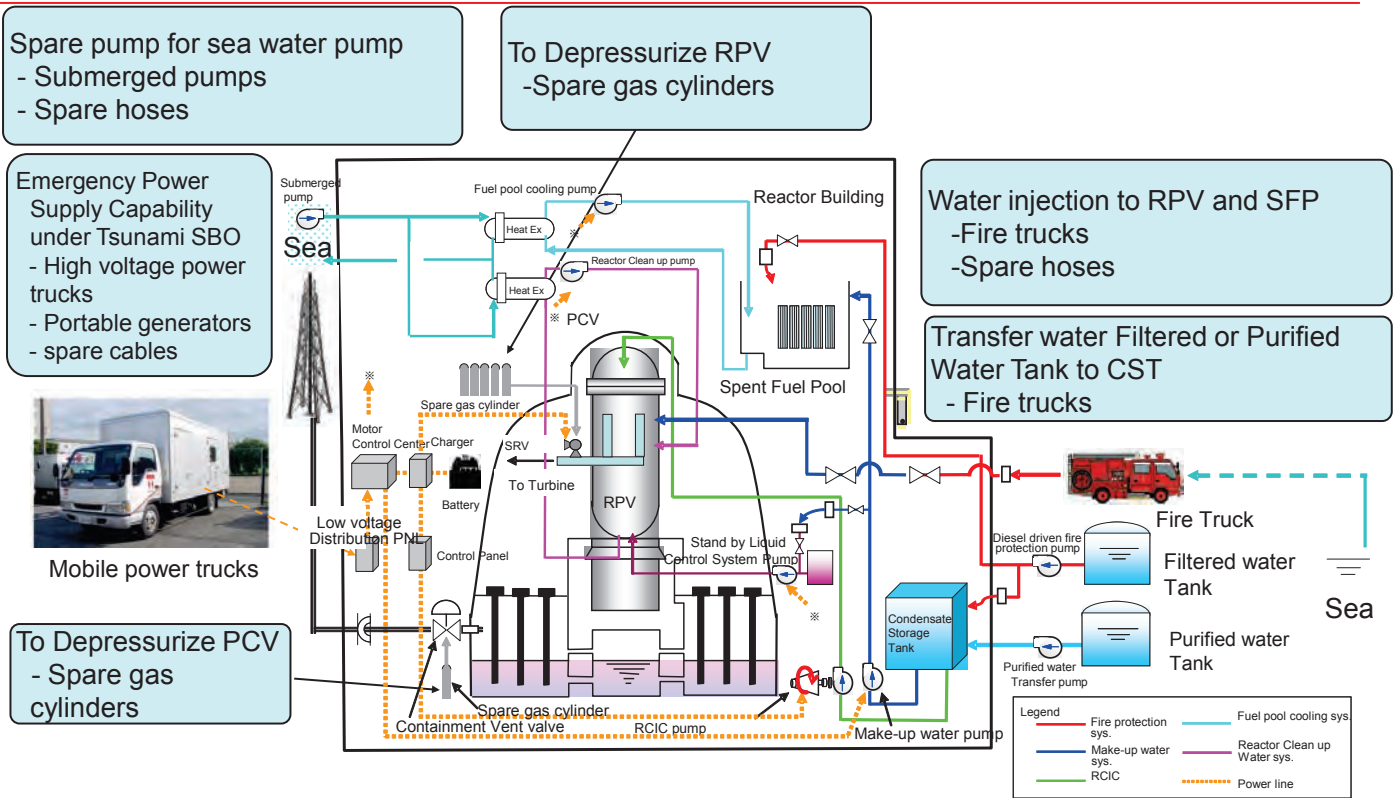

Revamped safety at TEPCO's 7-unit nuclear power station.



Further Safety Measures at Kashiwazaki-Kariwa NPS

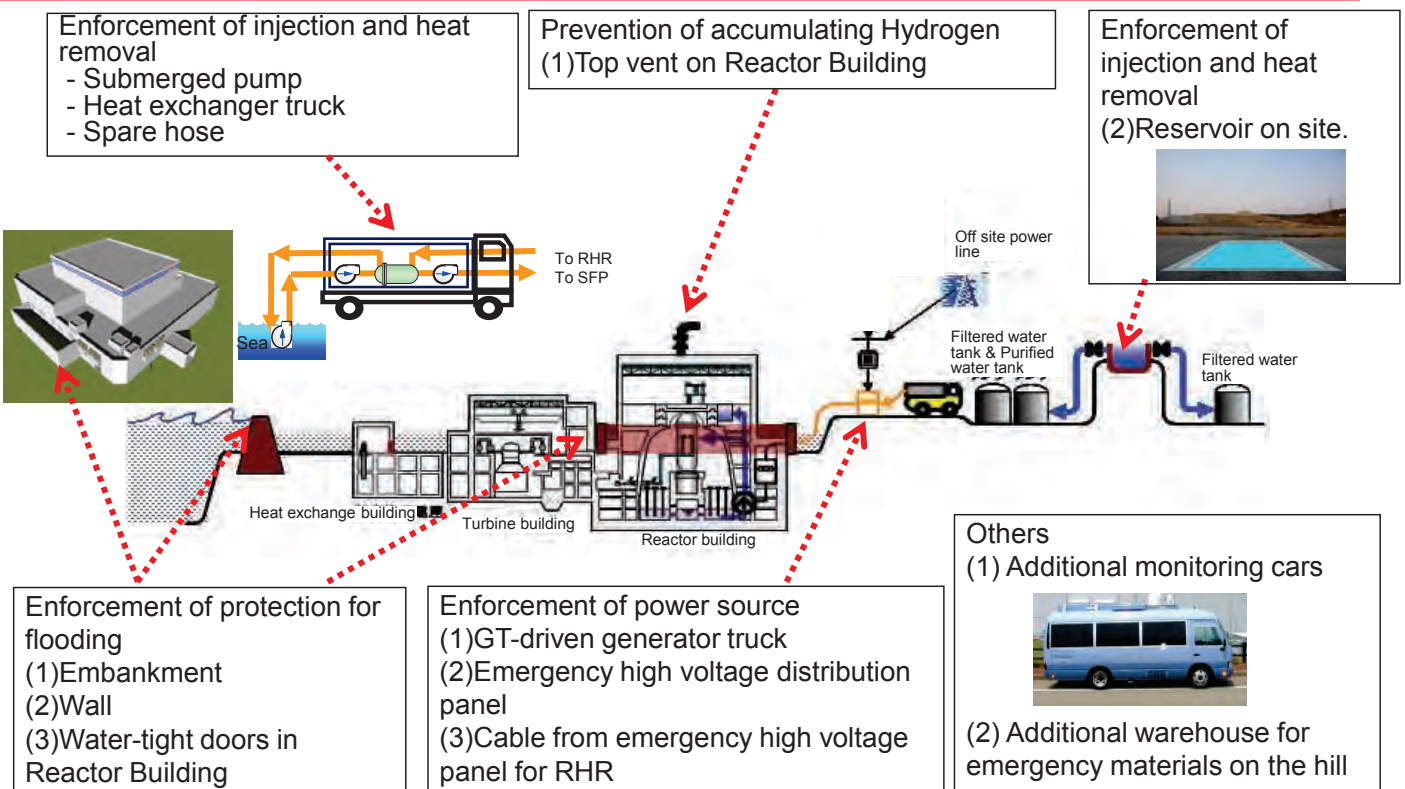

Further revamping safety at TEPCO's 7-unit nuclear power station.



Embankment (Kashiwazaki-Kariwa NPS)

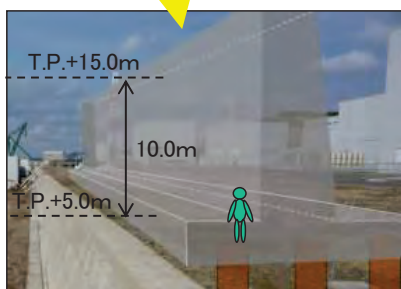
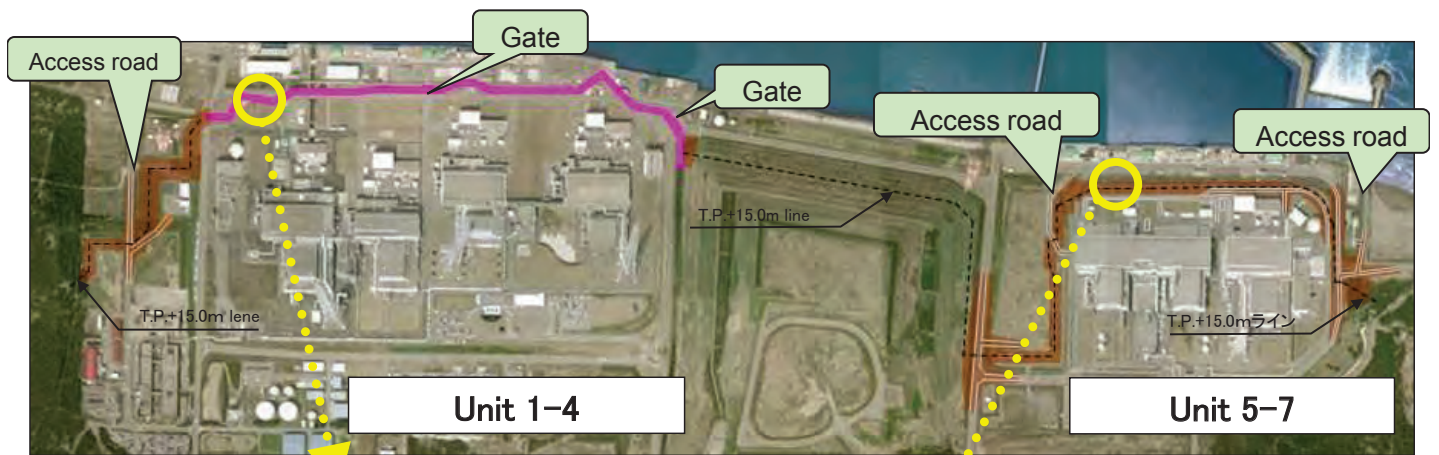

 : Reinforced concrete wall (image)

 : Clay embankment image



Flooding barriers

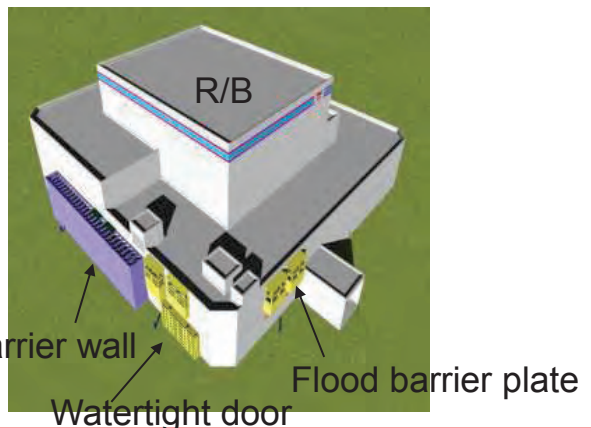
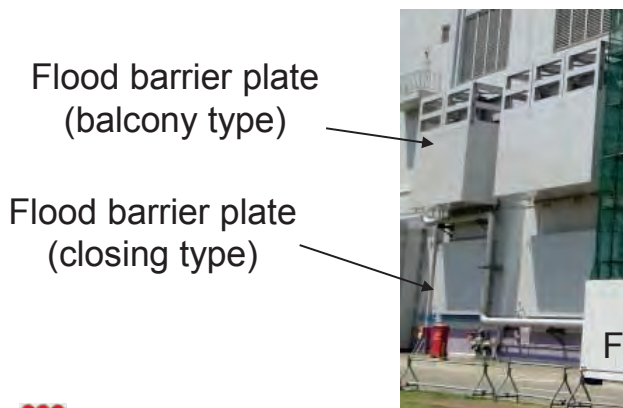
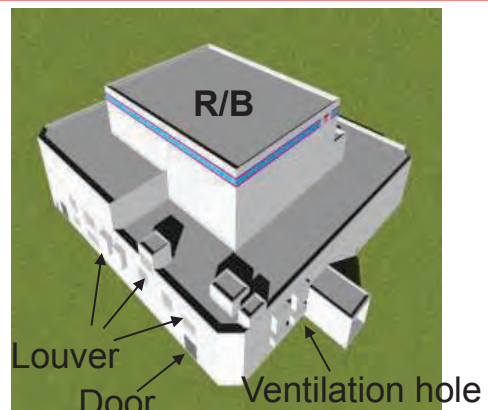
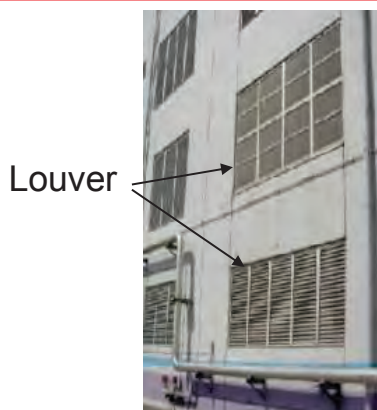

Watertight doors



Penetrations sealed with silicon rubber



Backup AC Power (Air Cooling GTG & Mobile Power Truck)

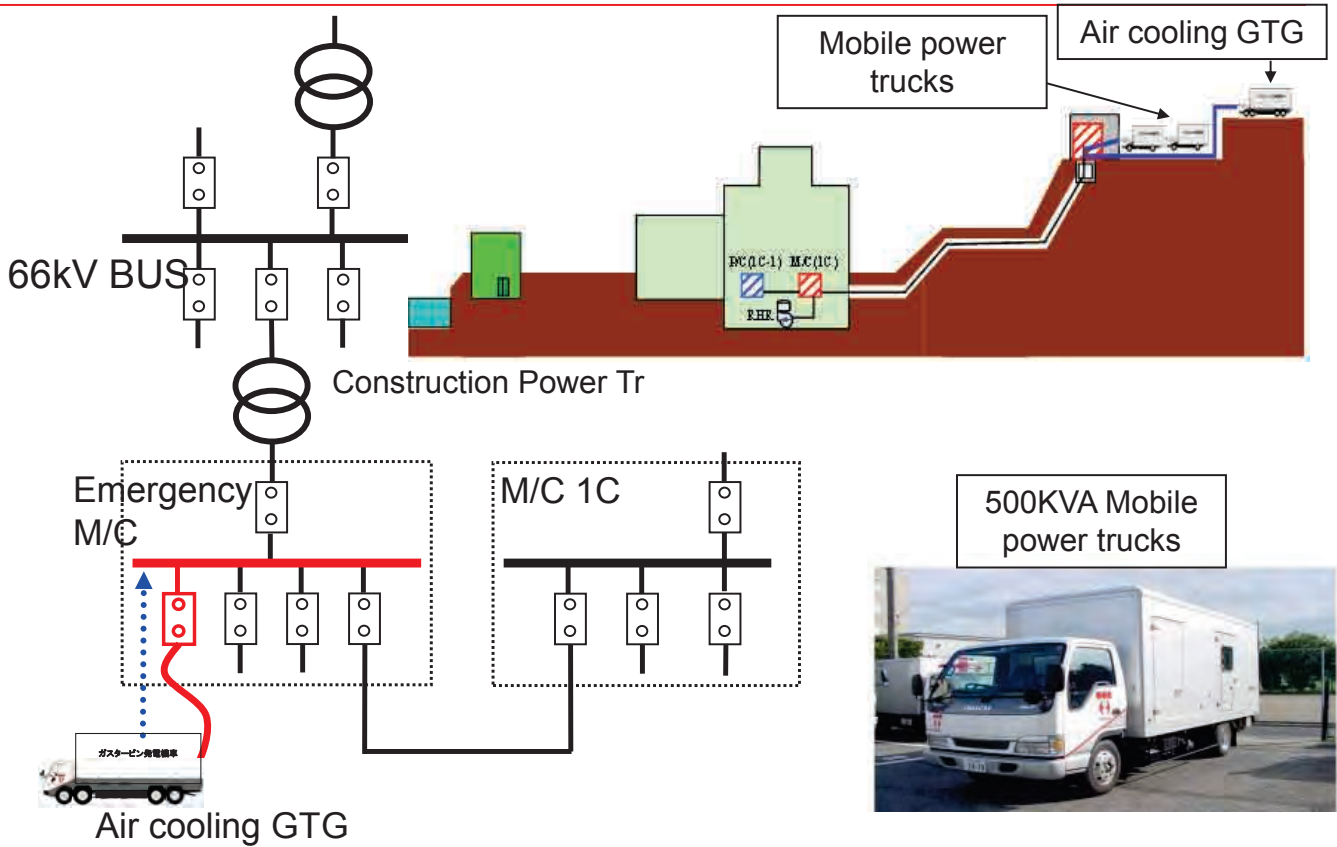

Enhancing Reactor Depressurization

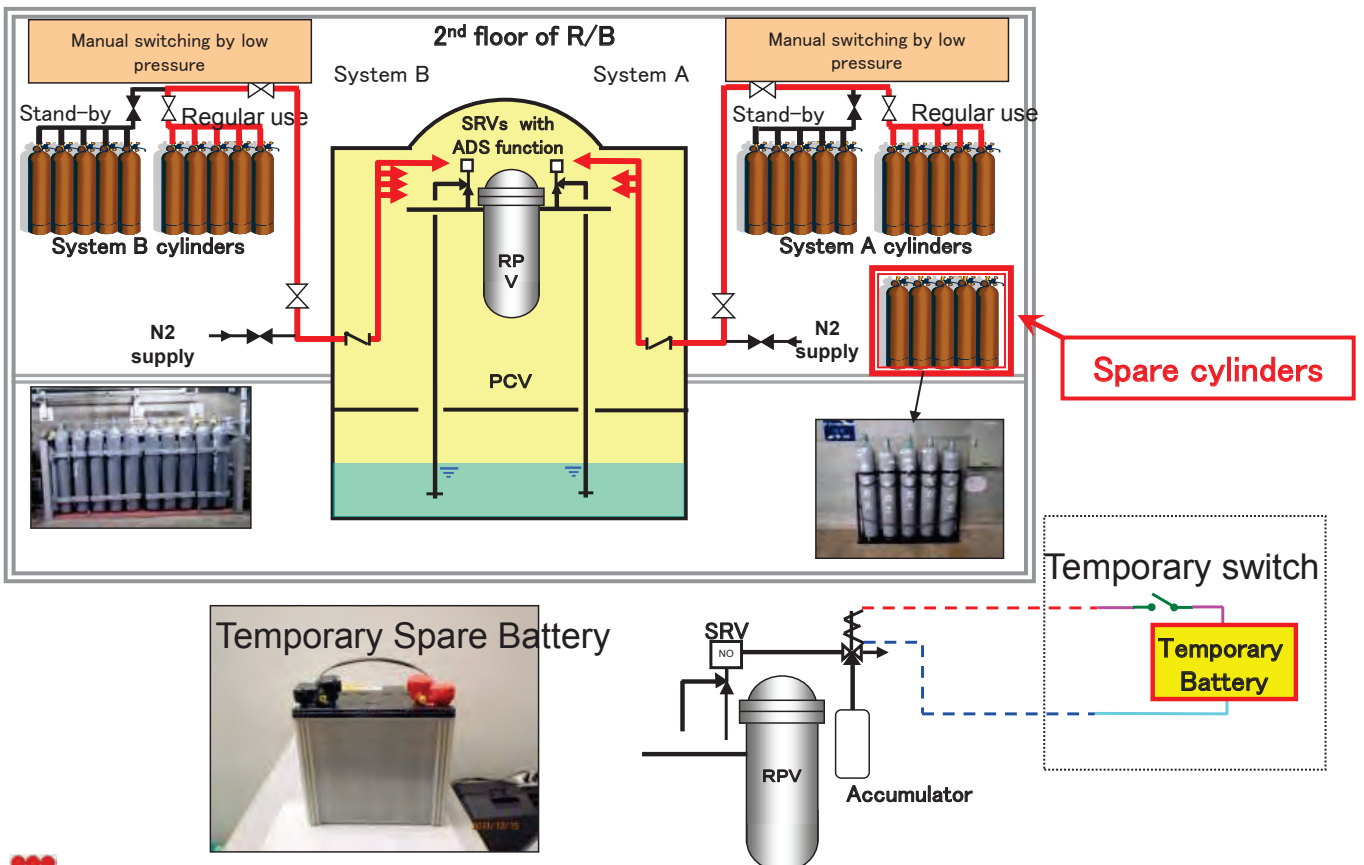

Low Pressure Injection by Fire Engine

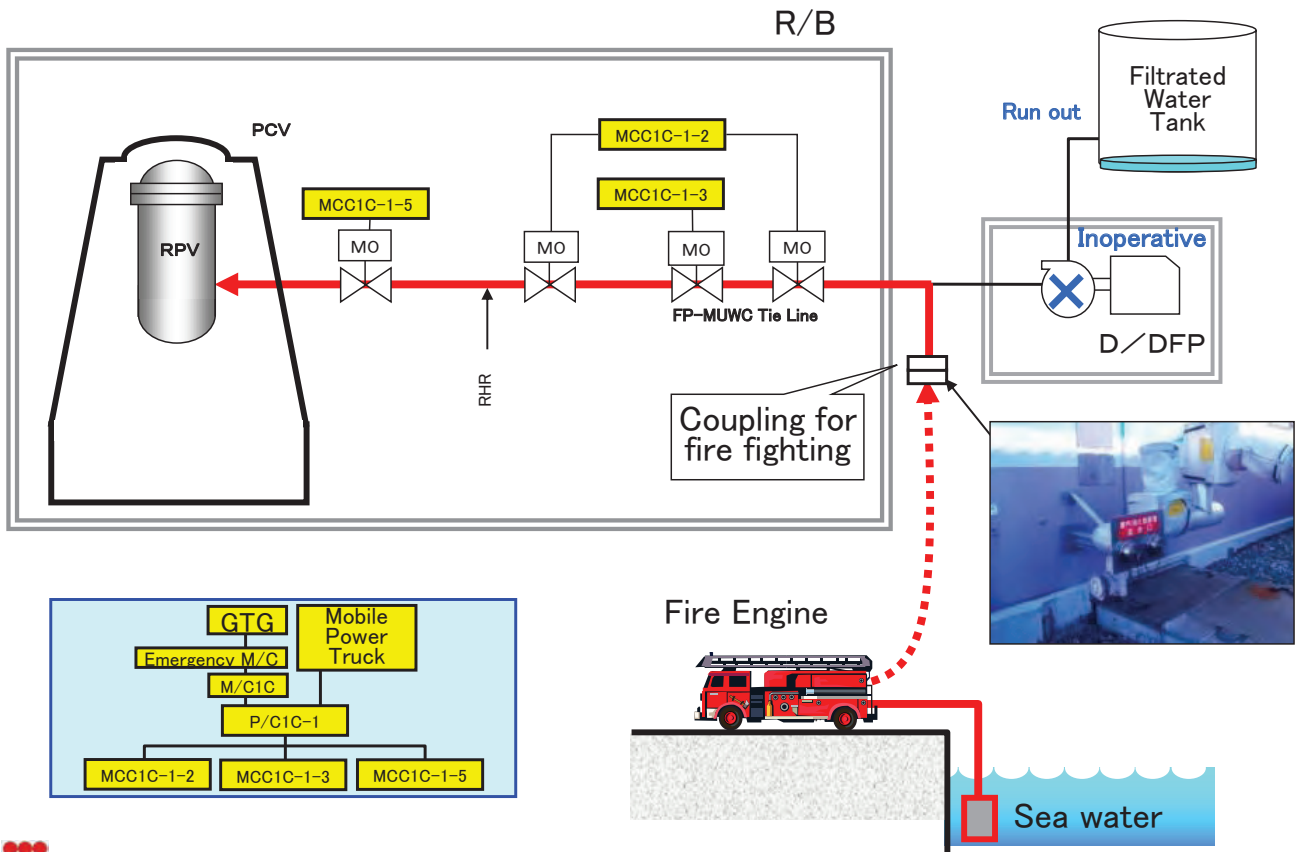

Water Reservoir

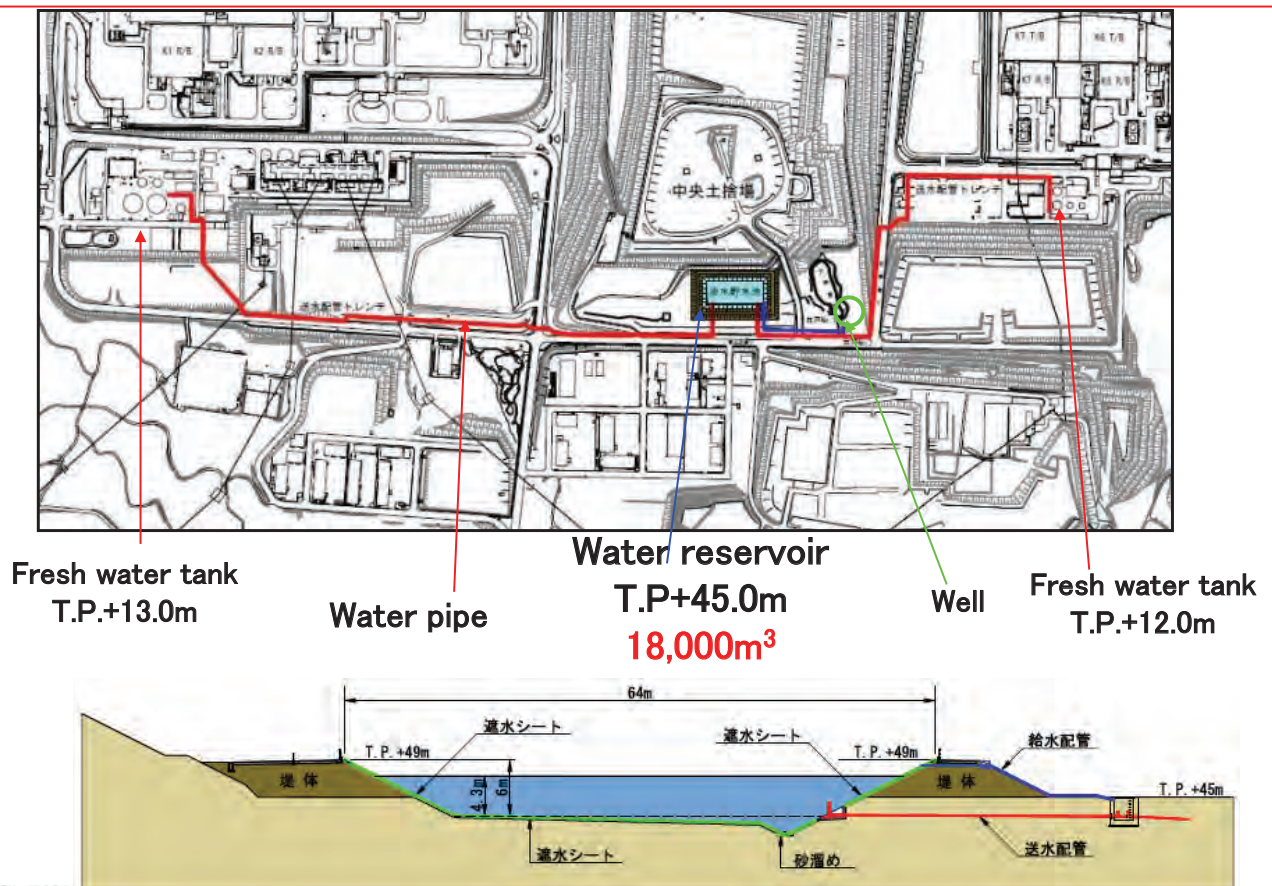

Alternative Heat Removal

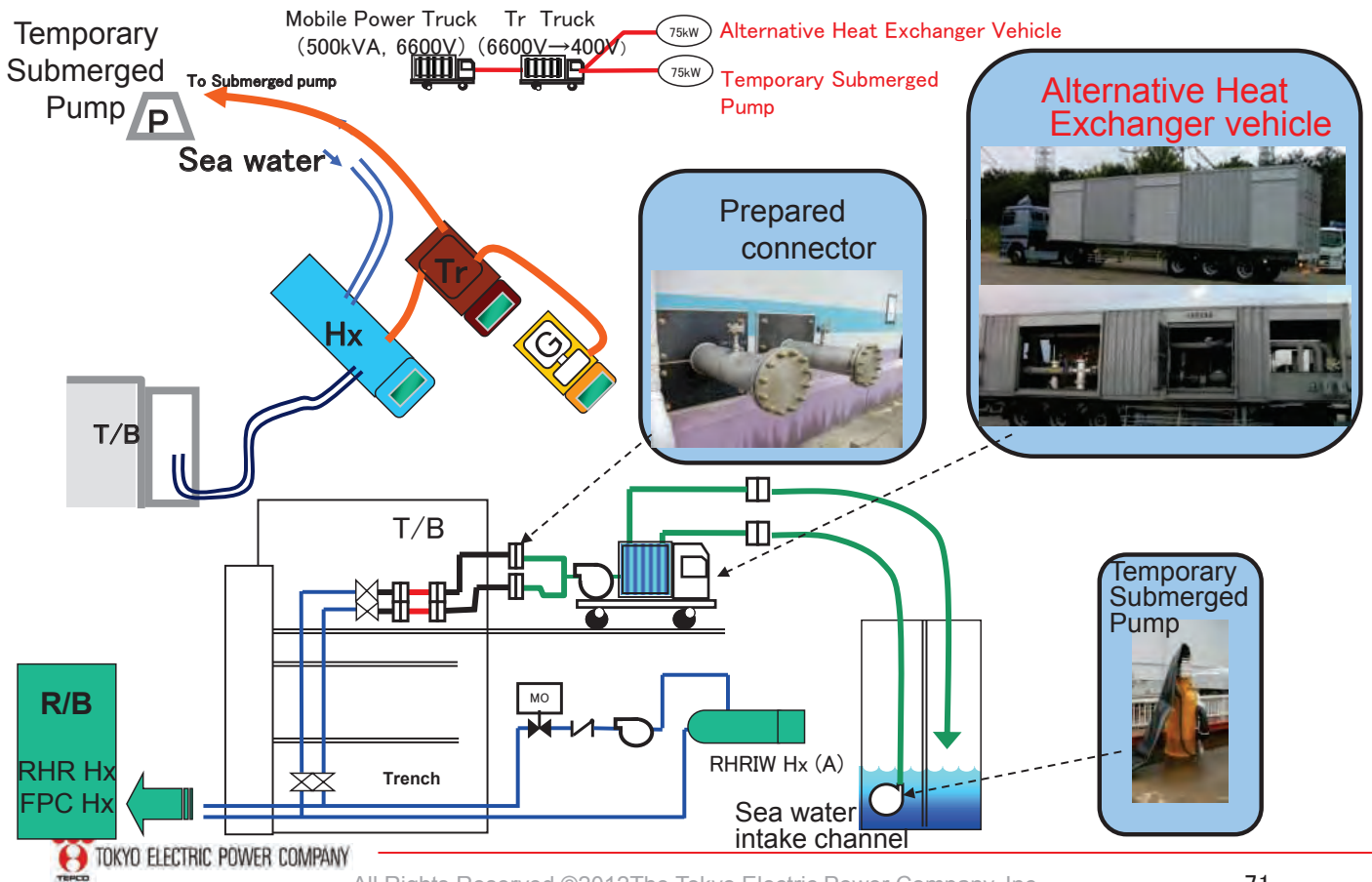

PCV Venting (Ensuring Actuation)

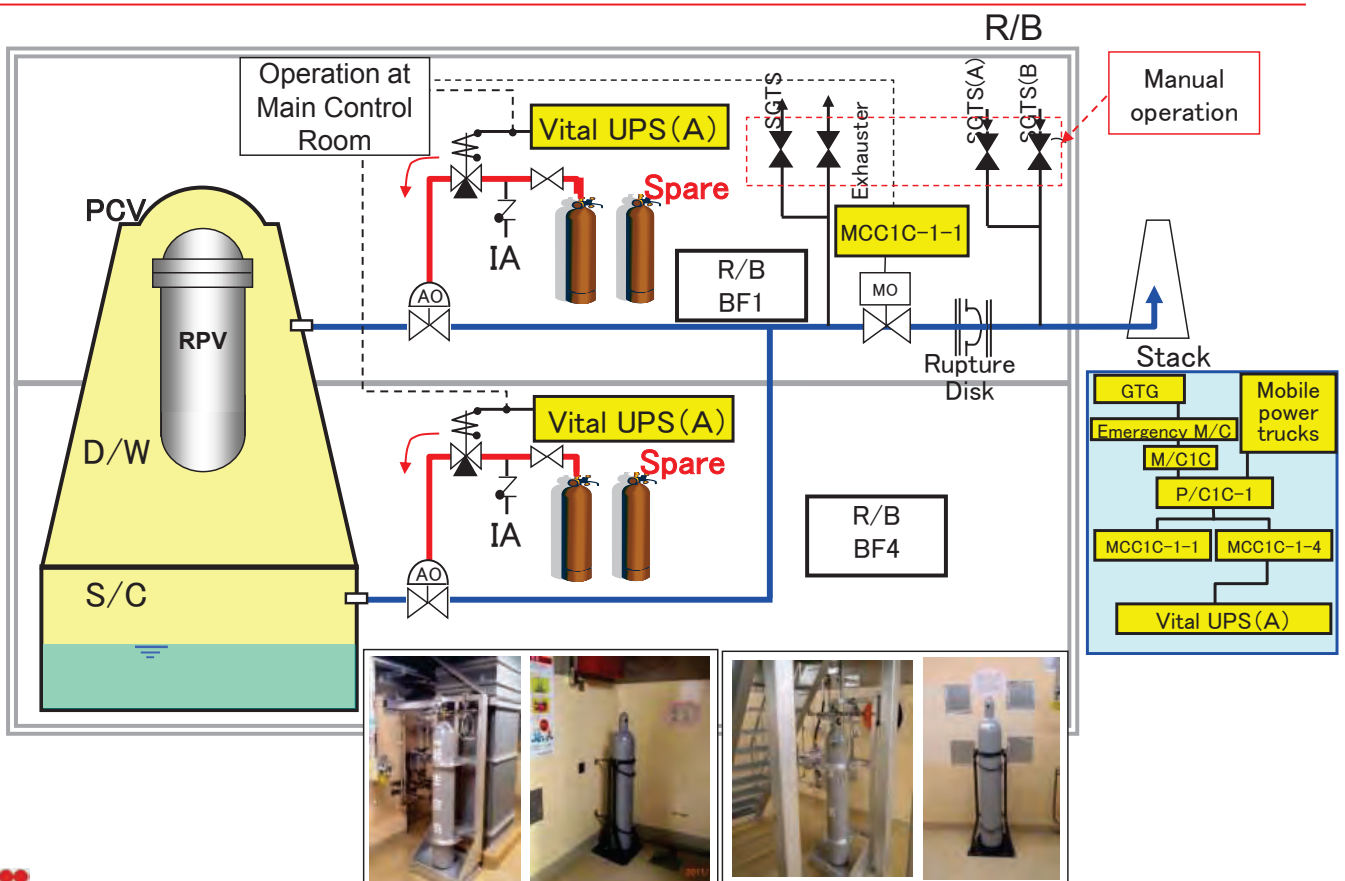

PCV Venting (Manual Operation at Field)

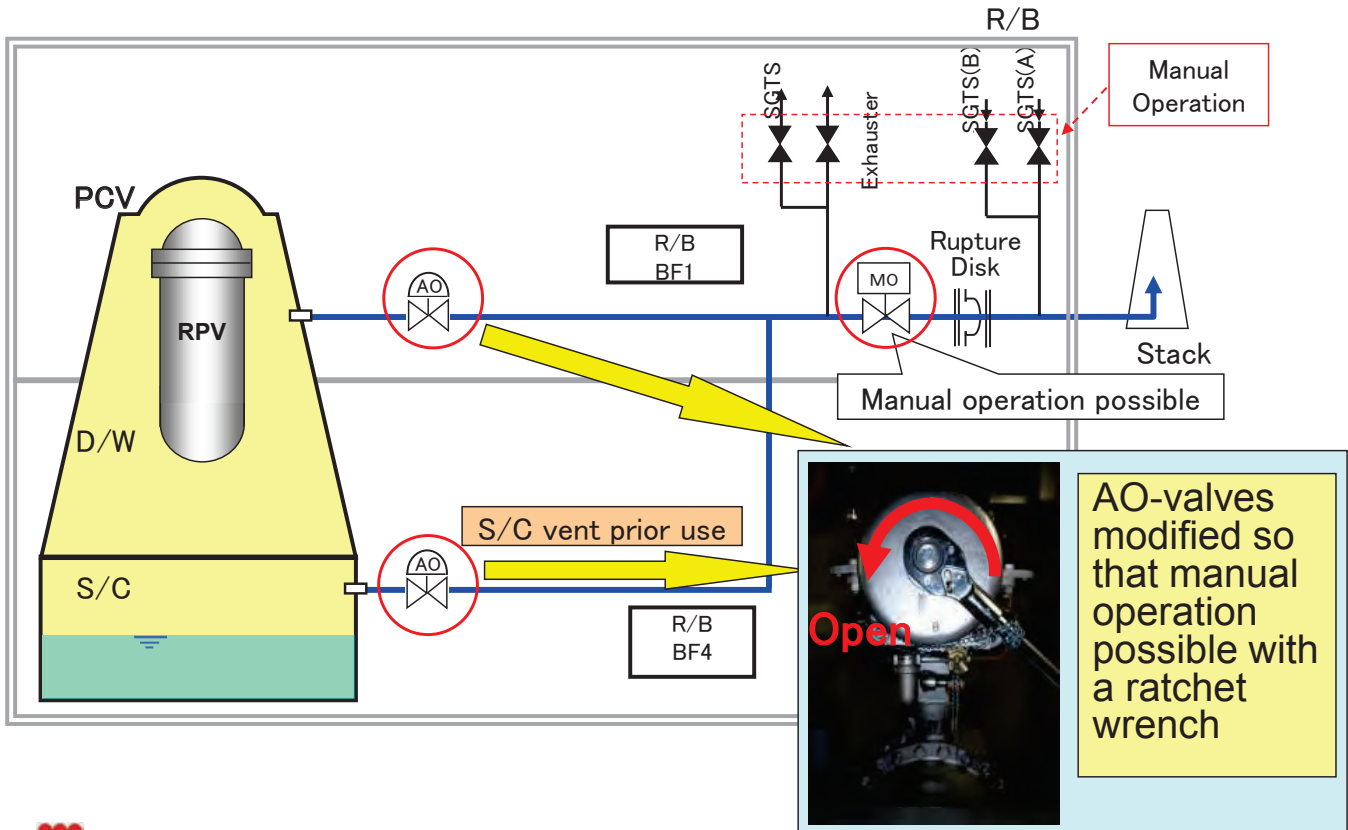

R/B Top Vent

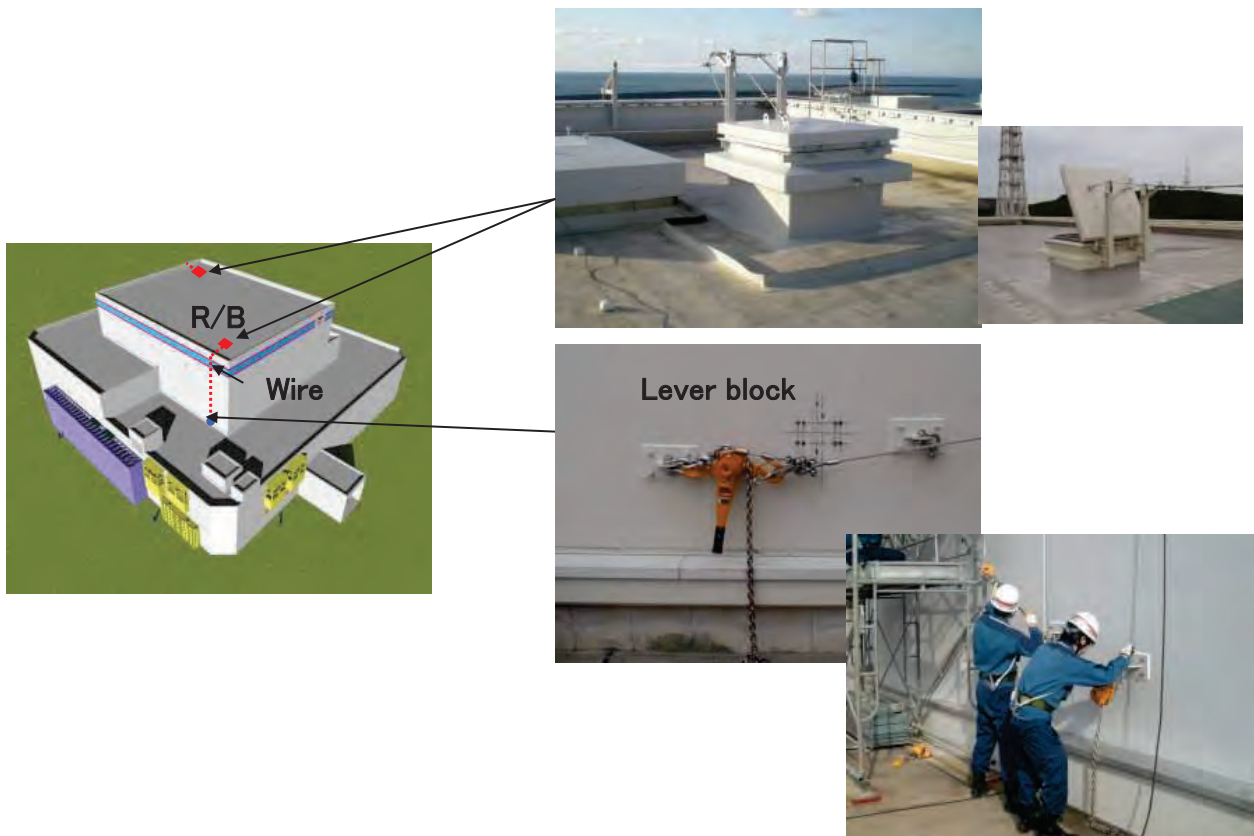

Provision of Heavy Machinery

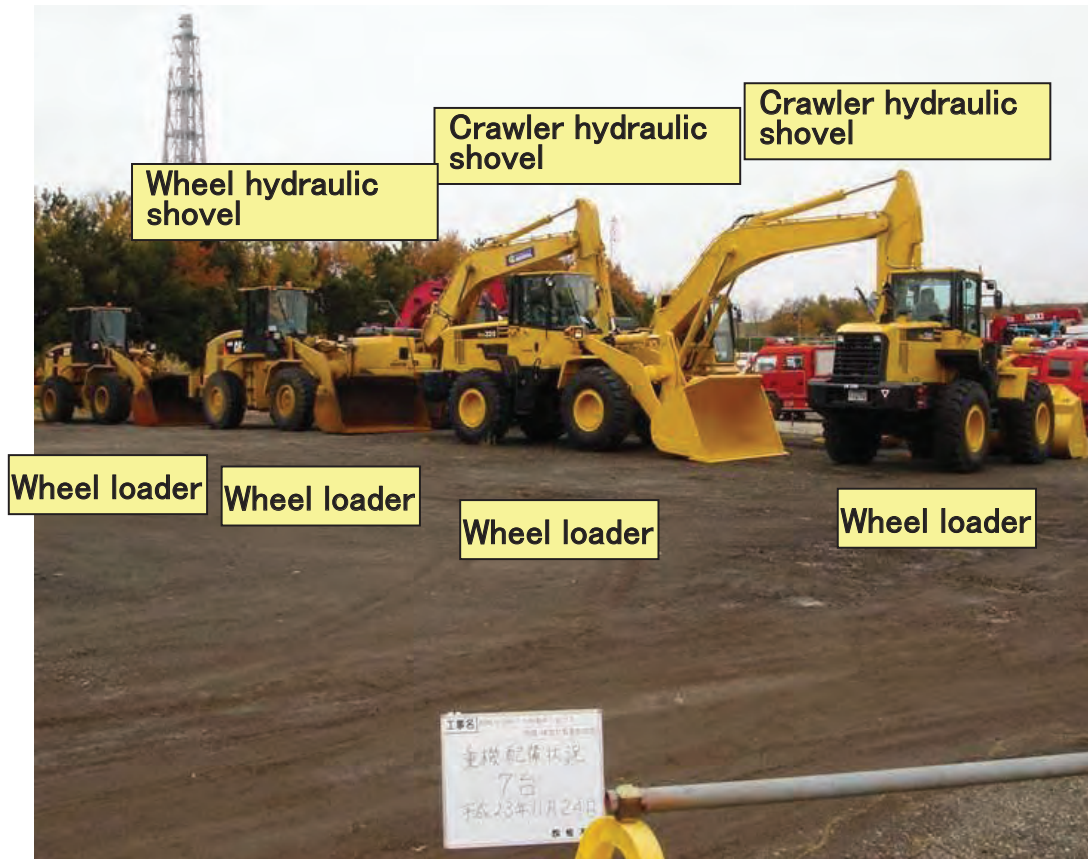
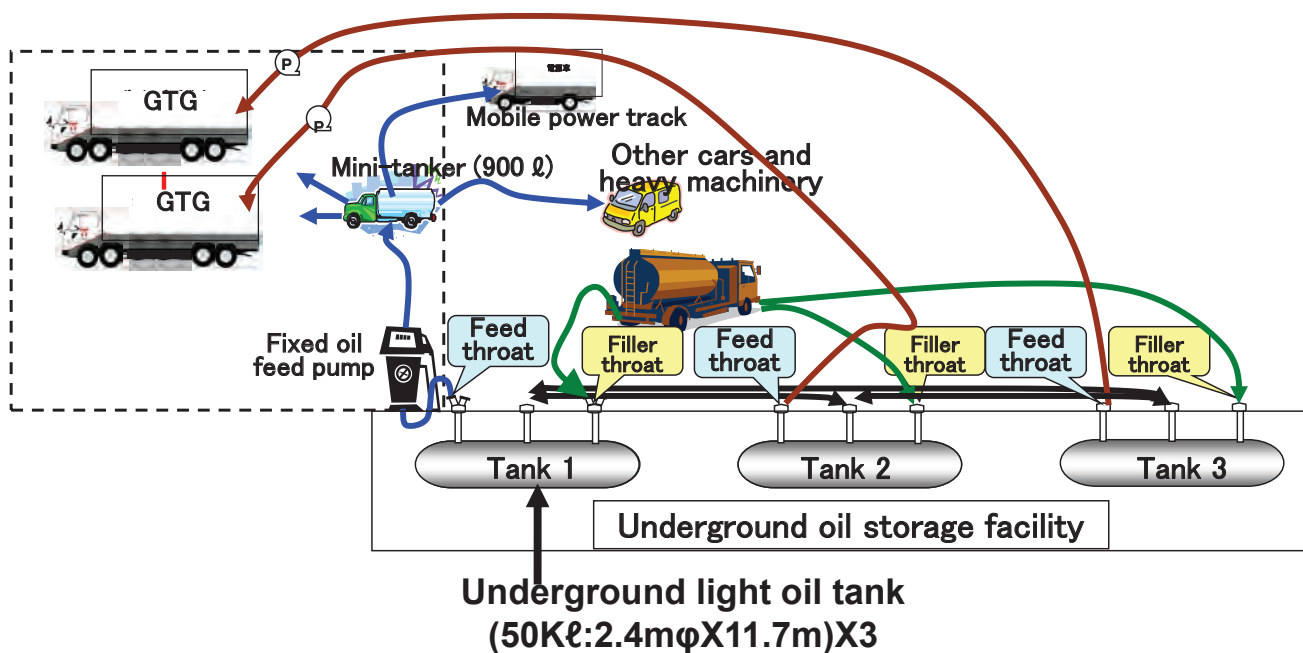
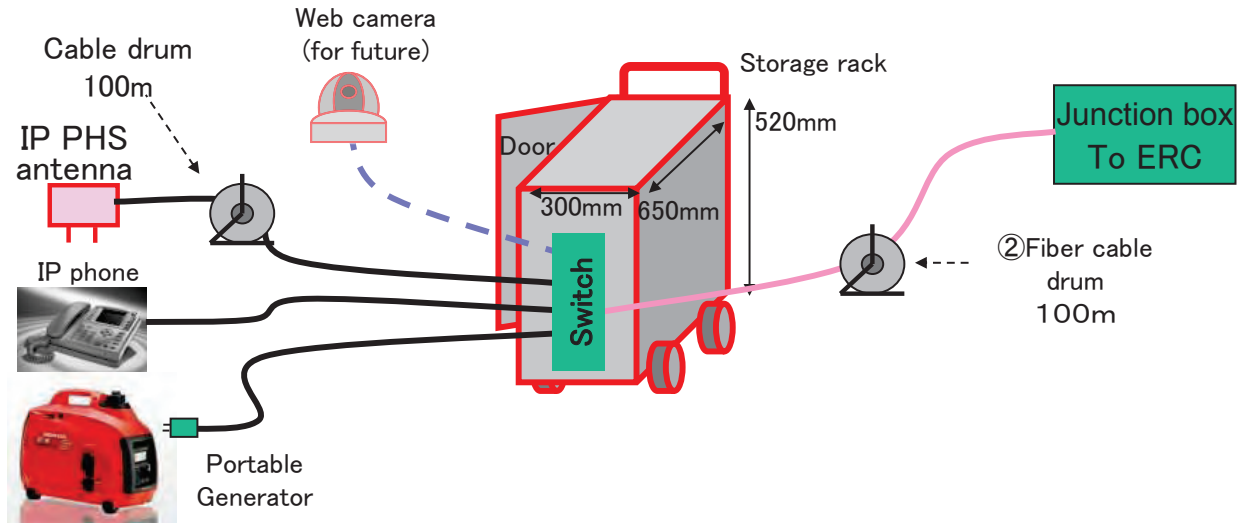

Image of Light Oil Storage Facility



Portable PHS Antenna (Image)



Added Monitoring Cars



Portable Monitoring Post



Ionisation chamber type survey meter



Dust Sampler

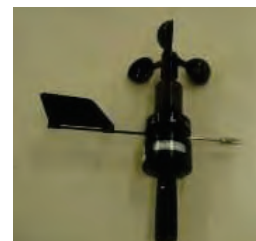

vane anemometer



Portable generator



Satellite cell-phone

In Closing

- Achieved Stable Conditions
 - ✓ Condition equivalent to cold shutdown
 - ✓ Significant decrease of radioactivity emissions
- Commenced the phase 1 of Mid-and-long-Term Roadmap towards the Decommissioning of 1F Units 1-4
 - ✓ Phase 1: Period to the commencement of the fuel removal from the Spent Fuel Pools (Within 2 years)
- Implementing measures to enhance safety of Kashiwazaki Kariwa NPS.
 - ✓ Deployed mobile power trucks, additional fire engines, spare pumps and motors, etc.

Radiation Monitoring Activities and Environmental Decontamination Perspectives

Kimiaki Saito

**Headquarters of Fukushima Partnership Operations
Japan Atomic Energy Agency (JAEA)**

Contents

- I. Monitoring and mapping around the Fukushima nuclear site**

- II. Roadmaps and activities for environmental decontamination**

I. Monitoring and mapping

- 1. General monitoring by the Ministry of Education, Culture, Sports, Science Technology (MEXT), municipalities, etc.**
 - **A number of monitoring data have been accumulated by MEXT, municipalities, and many other organizations.**
 - **Air dose rates, dust monitoring, soil samples, water samples, bottom sediment, index species**
 - **Methods, precision and frequency of current monitoring were reviewed recently.**

- 2. Specific monitoring for constructing detailed contamination maps**

2. Specific monitoring for mapping

- **In order to estimate the impact of the nuclear accident and take appropriate countermeasures, it was necessary to obtain precise information on the contamination conditions.**
- **The Ministry of Education, Culture, Sports, Science Technology (MEXT) commissioned the Japan Atomic Energy Agency (JAEA) to construct detailed contamination maps based on reliable environmental monitoring.**

Contamination maps

1. Soil contamination map

2. Car-borne survey map

3. Air-borne survey map

1. Soil contamination maps

- Collection of more than 10,000 soil samples over a wide region
- Analysis of radionuclides in soil samples using Ge detectors at 22 institutes
- Cross check of measurements among the 22 institutes using common soil samples

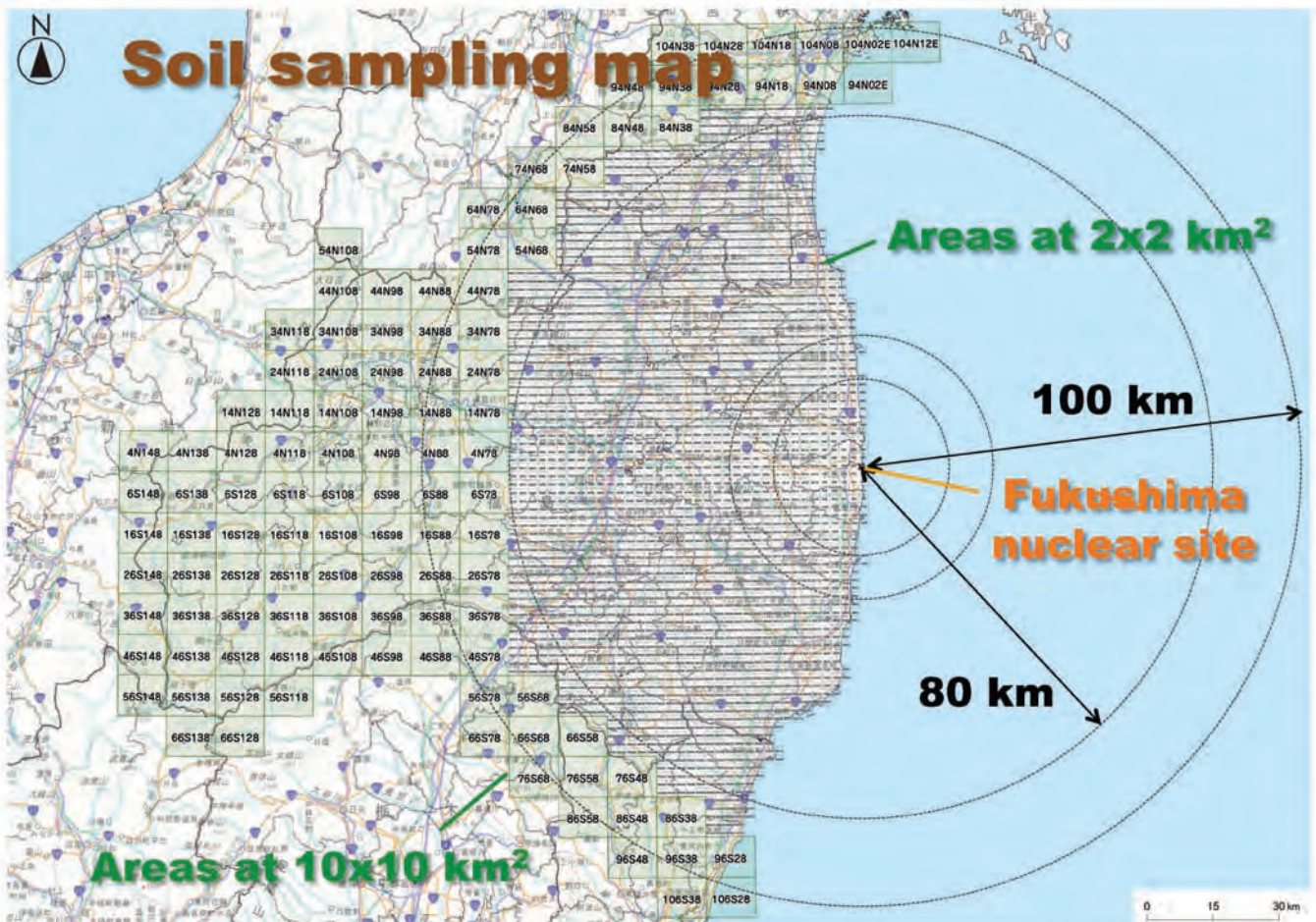
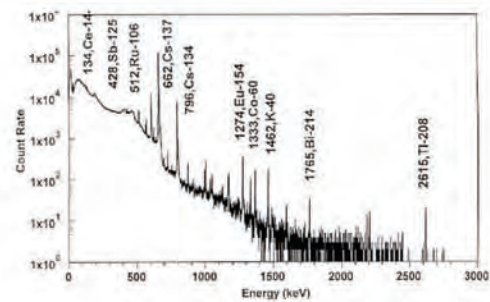
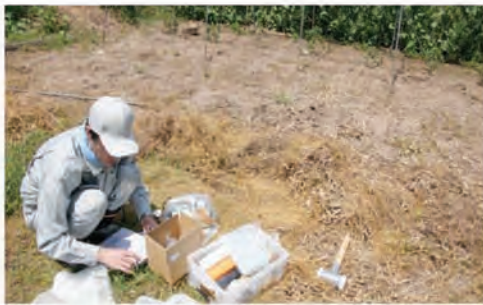

Collection procedures of a soil sample



● **Top 5 cm soil**

● **Sufficient mixing**

● **U8 plastic container**



Soil contamination maps

1. Gamma-ray emission nuclides

- Cs-137 (30.2 y) ● Cs-134 (2.06 y)
- I-131 (8.02 d)
- Te-129m (33.6 d) ● Ag-110m (250 d)

2. Alpha-ray emission nuclides

- Pu-238 (87.7 y)
- Pu-239 (24,100 y) + Pu-240 (6,564 y)

3. Beta-ray emission nuclides

- Sr-89 (50.5 d)
- Sr-90 (28.8 y)

(half life)

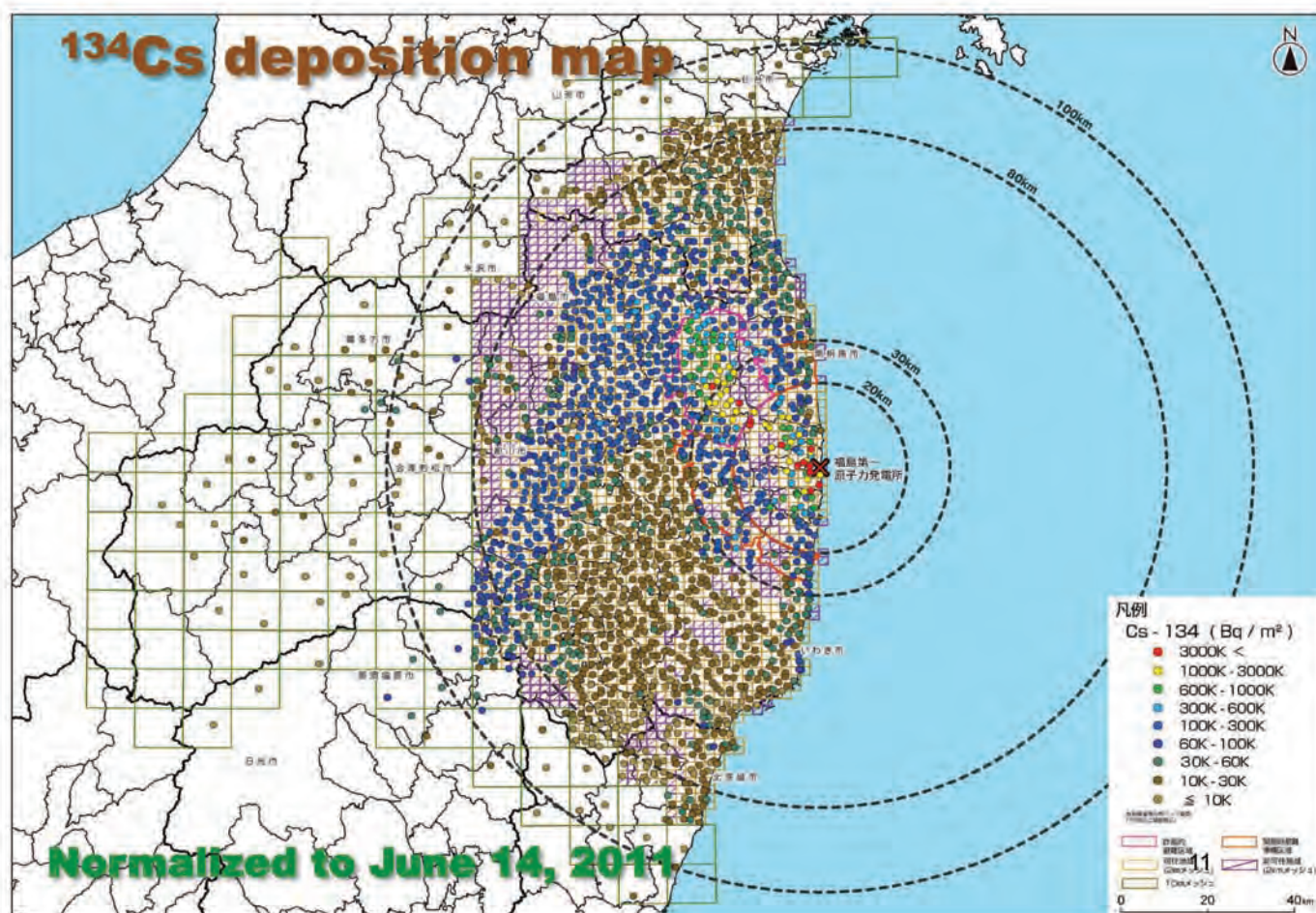
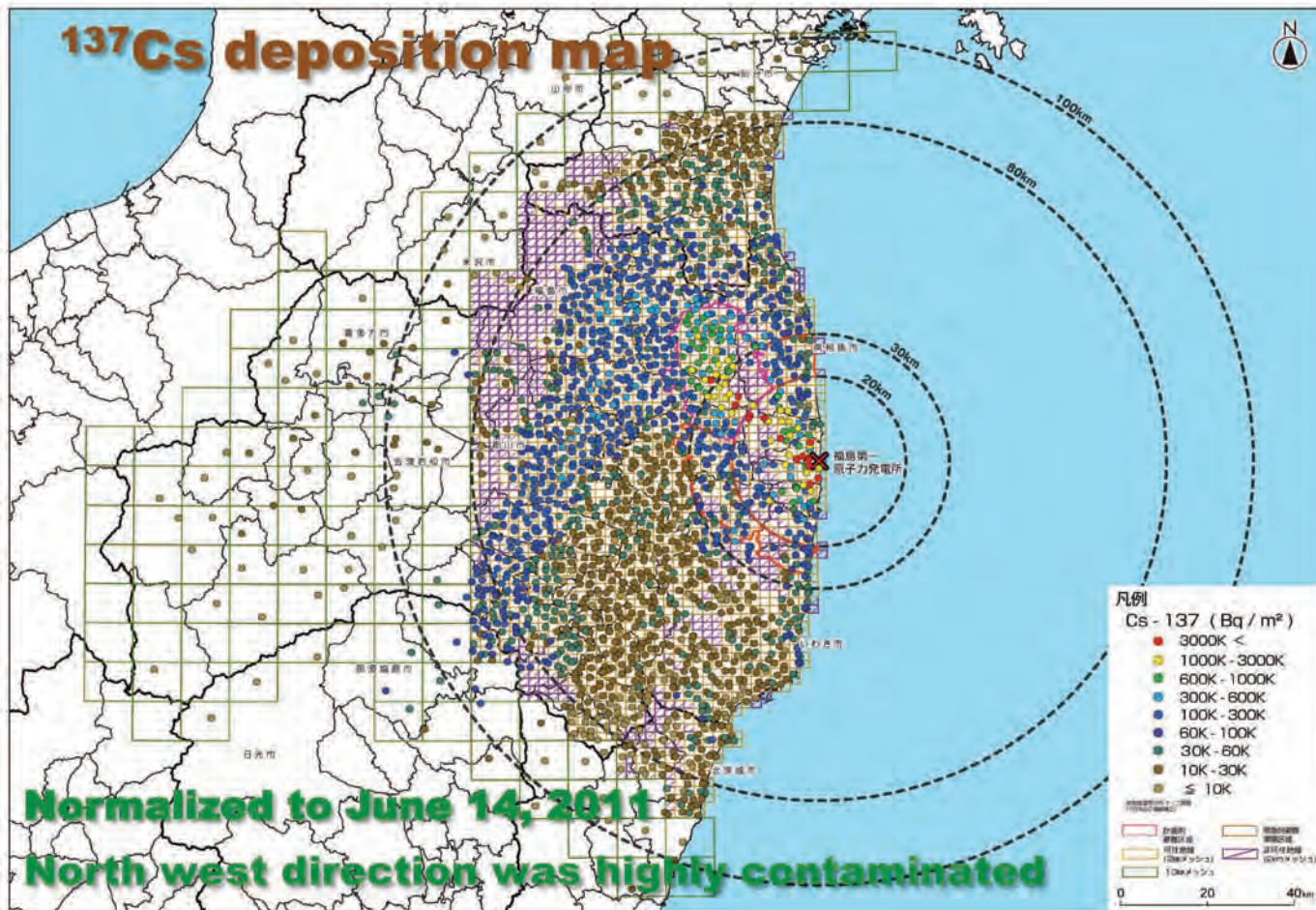

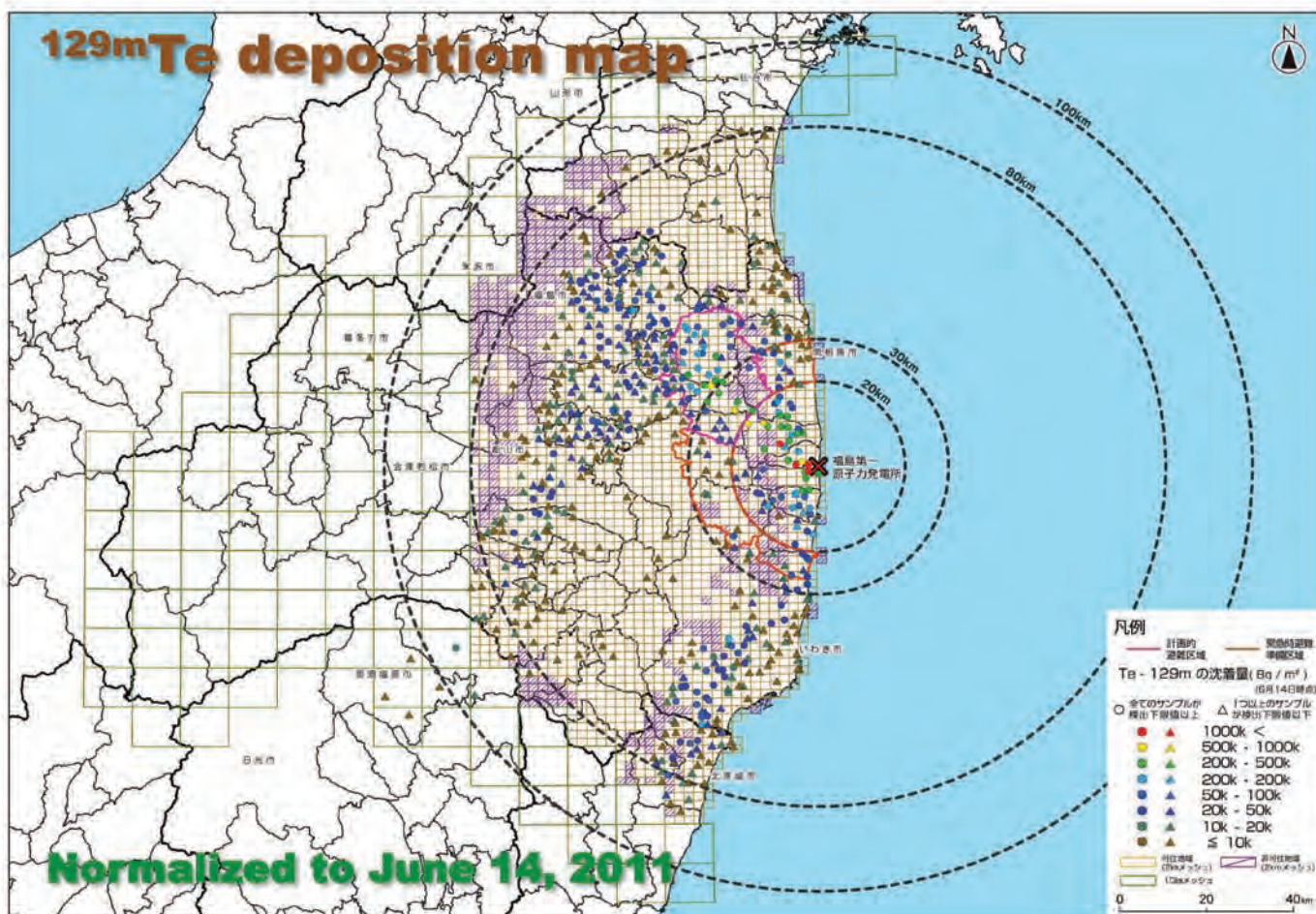
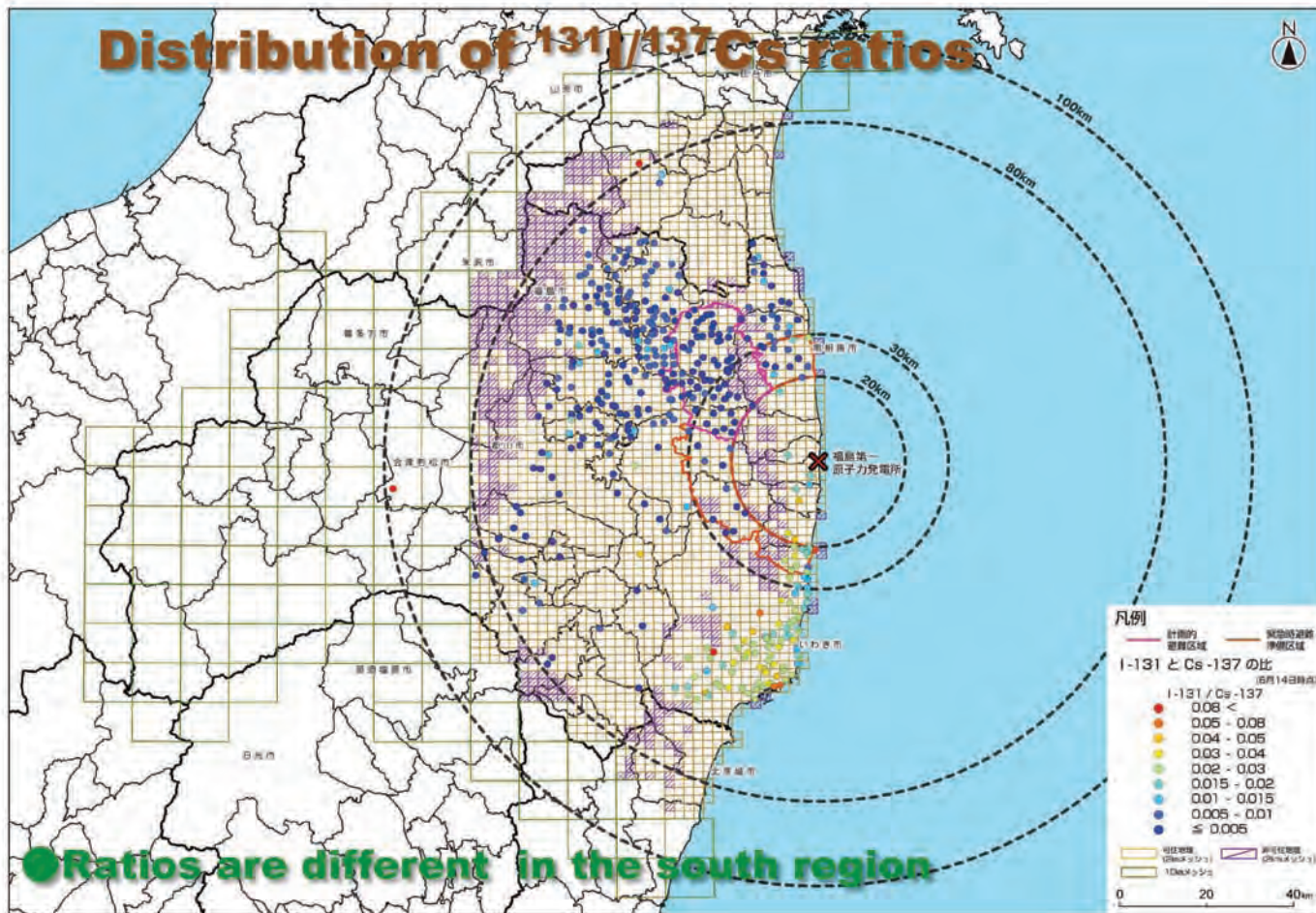

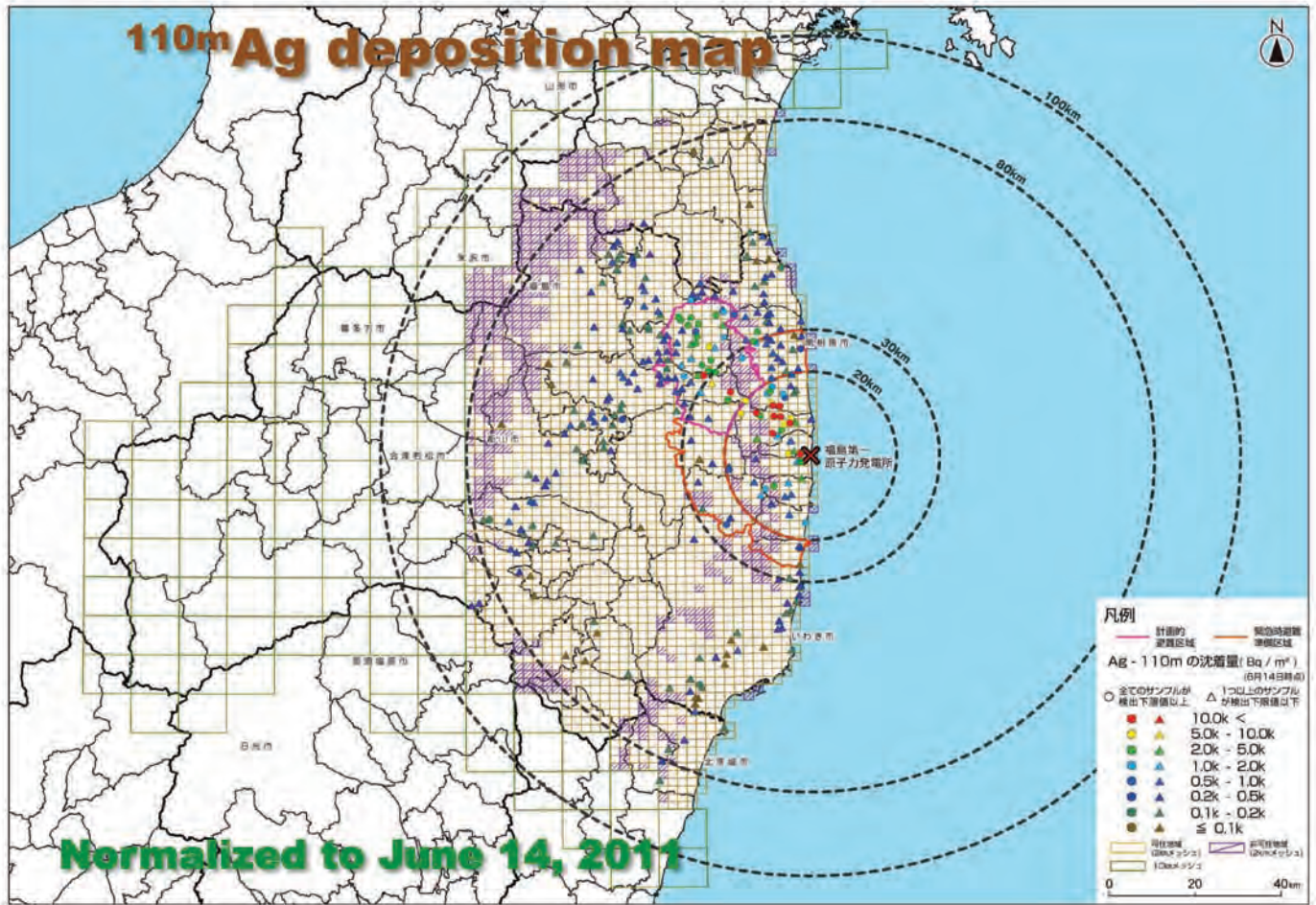

Evaluation of accumulated effective doses for 50 years

- Maximum nuclide concentrations of soil (Bq/m²) were used.
- External exposures and inhalation due to re-suspension were considered.

Nuclide	Half life	Maximum concentration (Bq/m ²)	Effective dose for 50 years	
			Conversion coef. (μSv/h)/(Bq/m ²)	Dose (mSv)
Cs-134	2.065年	1.4×10^7	5.1×10^{-3}	71
Cs-137	30.167年	1.5×10^7	1.3×10^{-1}	2000(2.0Sv)
I-131	8.02日	5.5×10^4	2.7×10^{-4}	0.015
Sr-89	50.53日	2.2×10^4	2.8×10^{-5}	0.0061(0.61 μSv)
Sr-90	28.79年	5.7×10^3	2.1×10^{-2}	0.12
Pu-238	87.7年	4	6.6	0.027
Pu-239+240	2.411×10^4 年	15	8.5	0.12
Ag-110m	249.95日	8.3×10^4	3.9×10^{-2}	3.2
Te-129m	33.6日	2.7×10^6	2.2×10^{-4}	0.6

(Dose coefficients from TECDOC-1162)

Contributions of dominant radionuclides to the total external effective dose

Nuclide	Ratio to the total effective dose rate
^{134}Cs	0.71
^{137}Cs	0.29
$^{129\text{m}}\text{Te}$	0.007
^{131}I	0.001
$^{110\text{m}}\text{Ag}$	0.001>

(June 14, 2011)

- Selected 45 locations

- Applied dose conversion coefficients to radioactivity per m^2 observed at the selected locations (June 14)

- Assumed $\beta = 1 \text{ g/cm}^2$

2. Car-borne survey maps

- Measurement of dose rates and GPS data per every ten seconds using a KURAMA system in a moving car
- Immediate data transfer through a cellular phone network
- Conversion of dose rates inside a car to those outside of the car



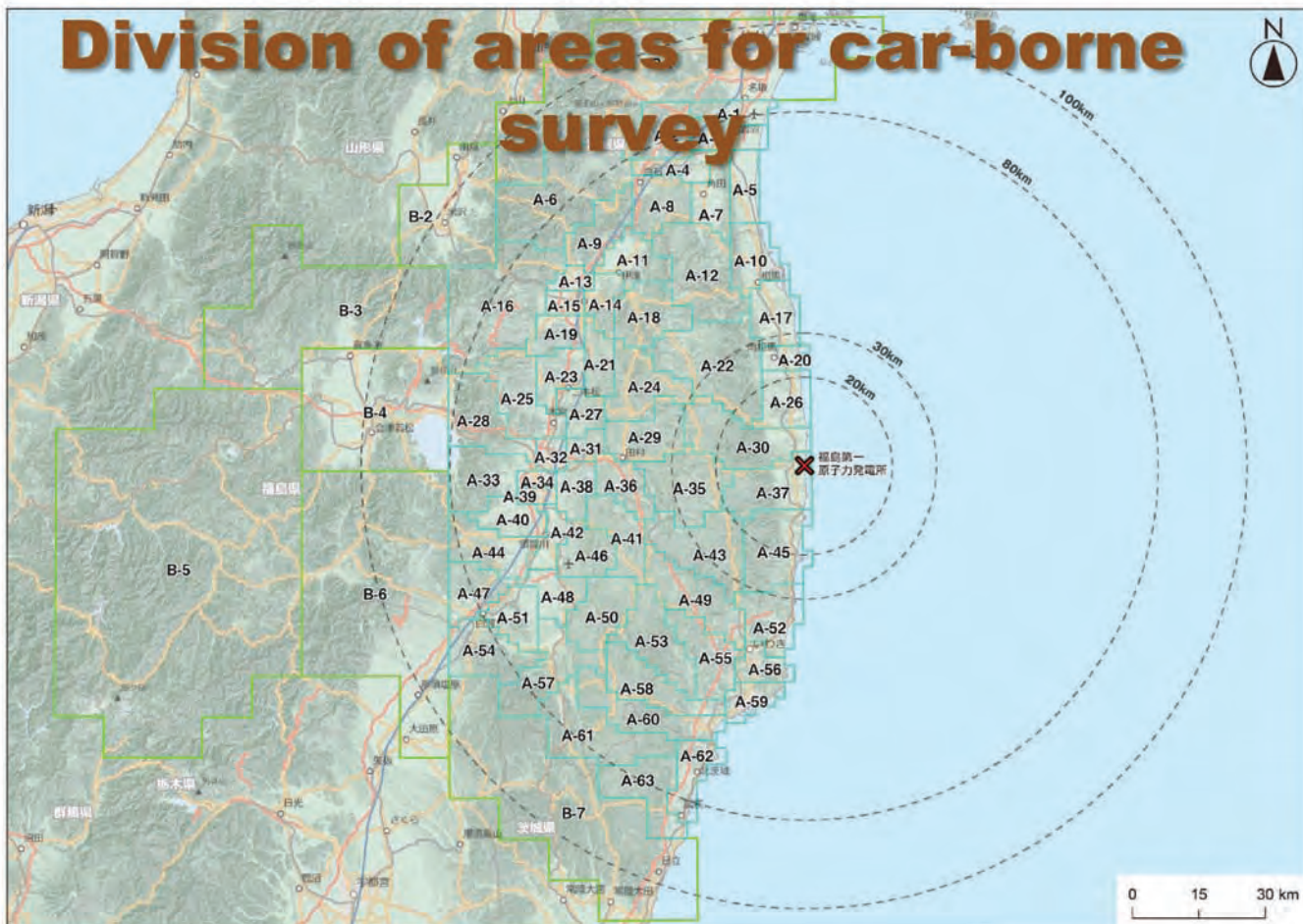

Real-time display of car-borne survey data

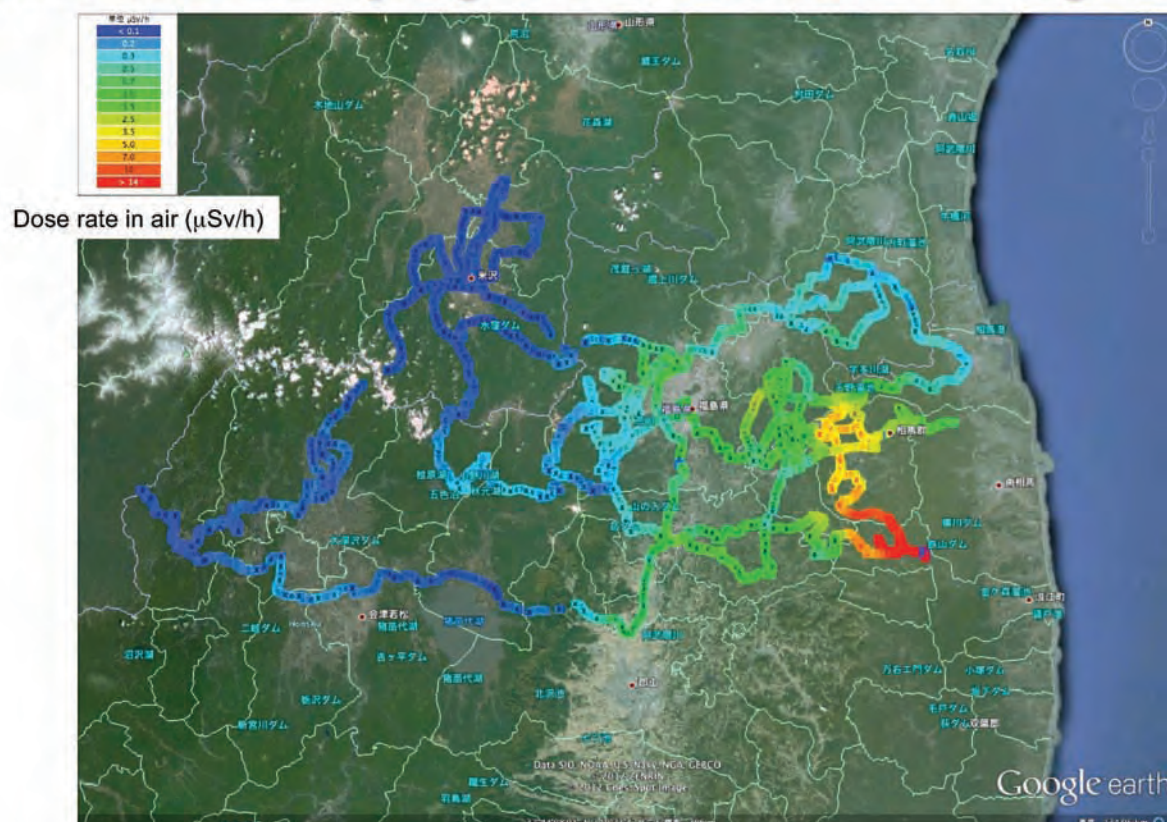

Near the Fukushima site

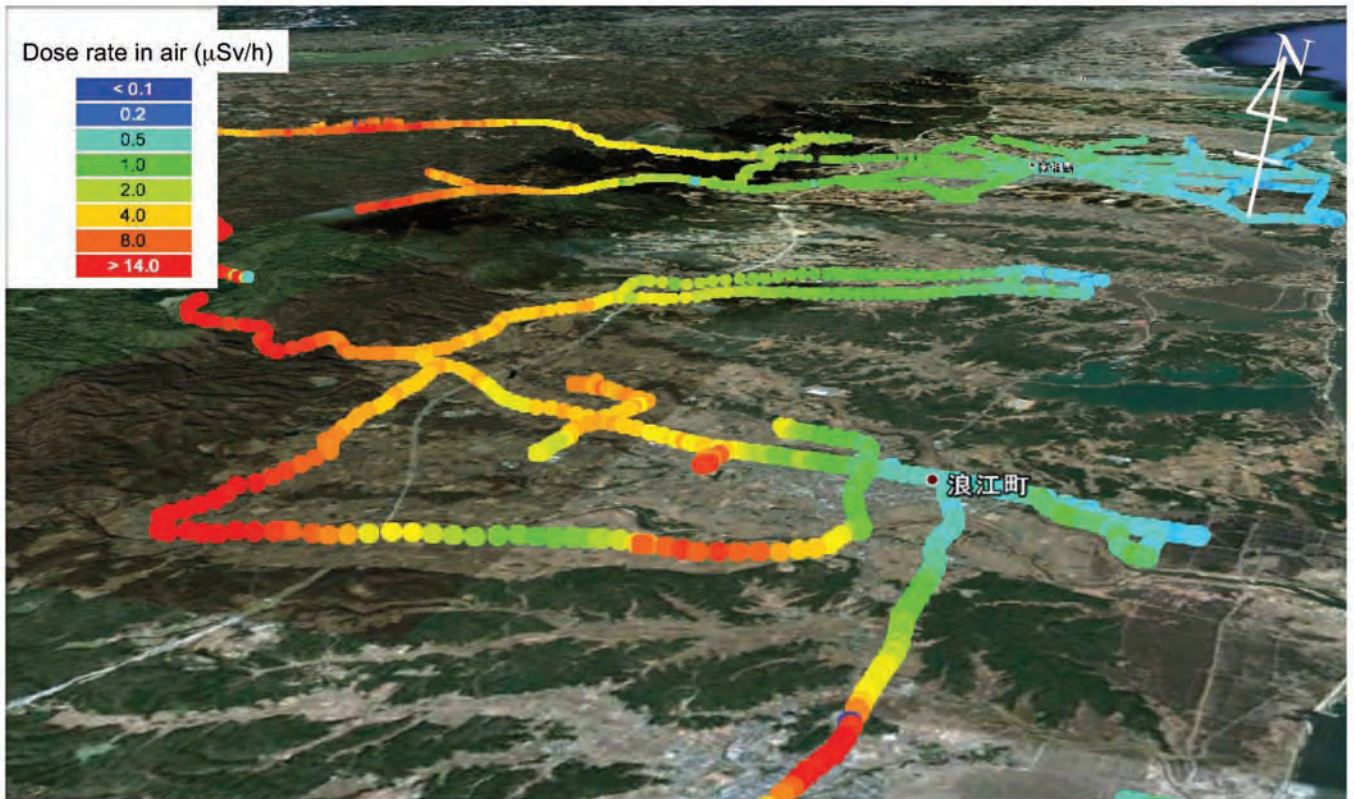

North west from the Fukushima site About 30 km



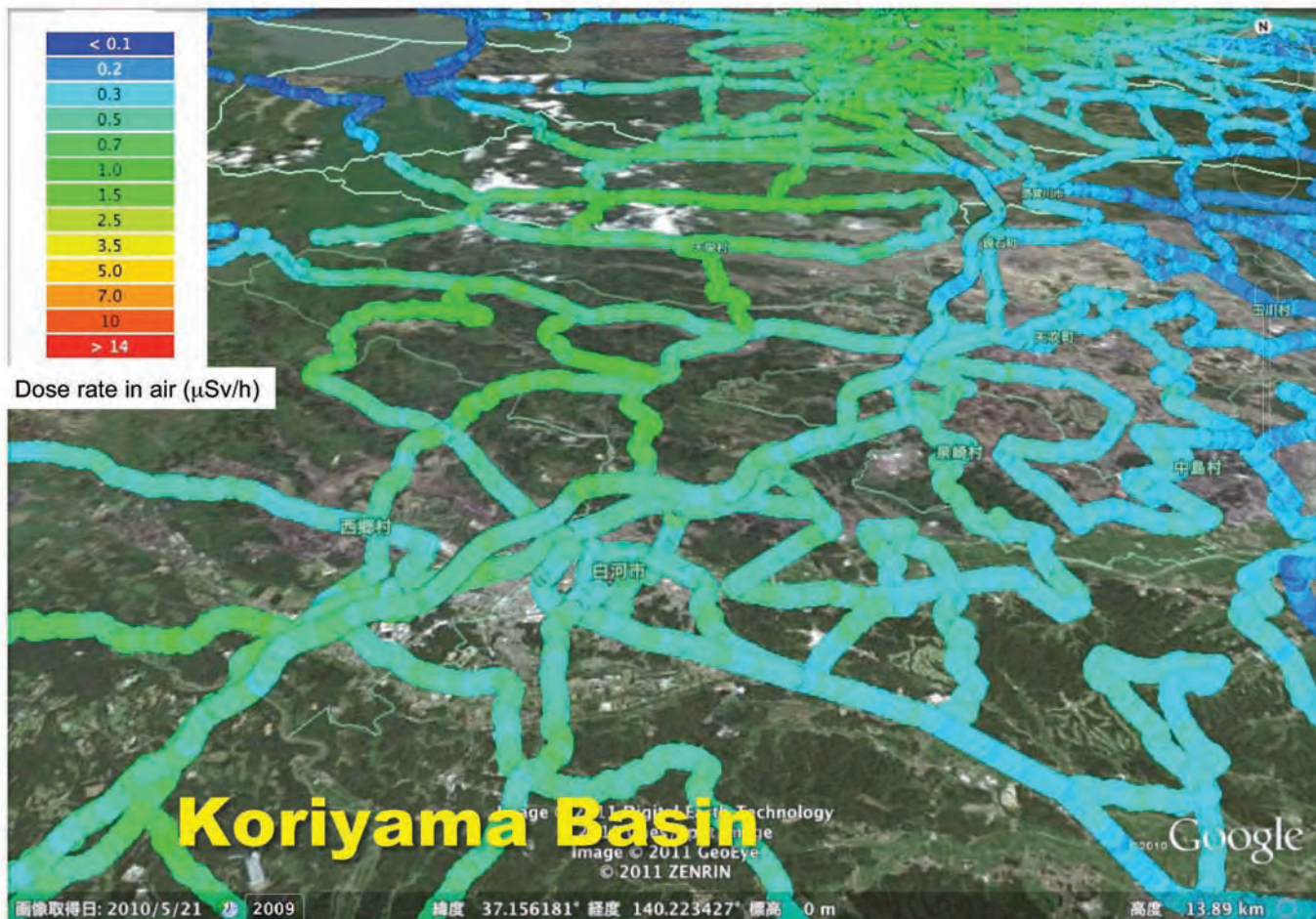

Car-borne survey results in June, 2011

- Superimposed on map data by the Geographical Survey Institute
- Total survey distance 17,000 km
- Corrected for noises, uncertainty in GPS data, tunnel data, etc.

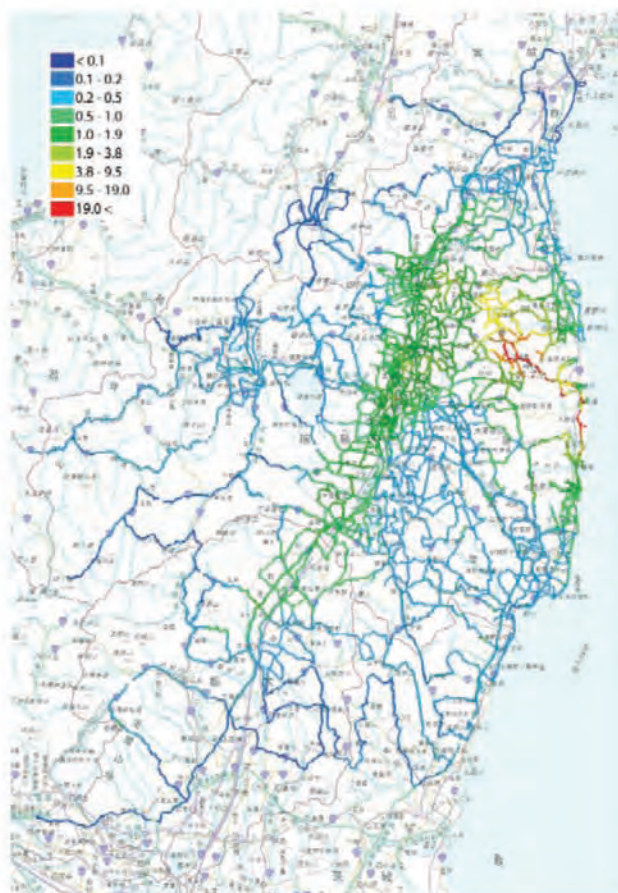

Car-borne survey results in December, 2011

- Total survey distance 39,000 km
- Wider contaminated area down to $0.2 \mu\text{Sv/h}$ was covered
- Used for determining decontamination areas

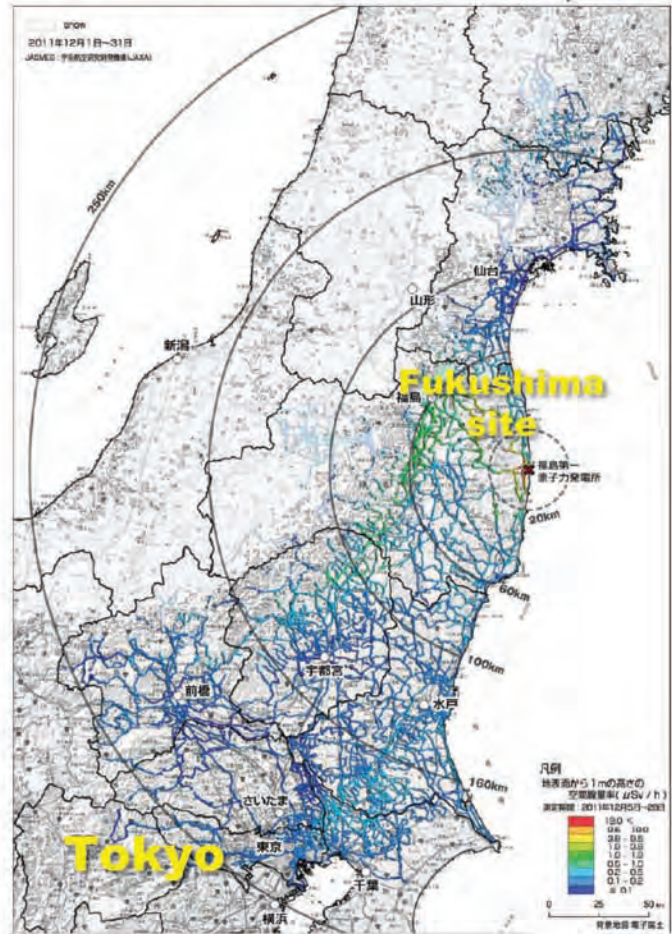

Comparison of car-borne survey results between June and December

- As a whole, dose rates in December are 30% lower than those in June: Dose rates decreased, especially on roads.
- Decrease in dose rate is smaller in evergreen forest.

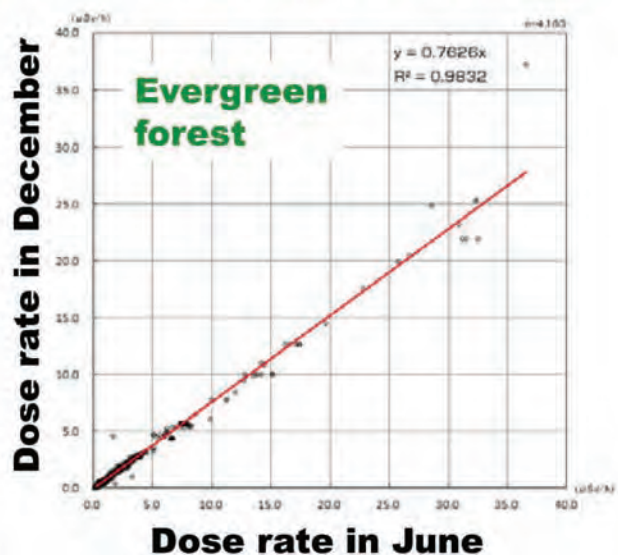
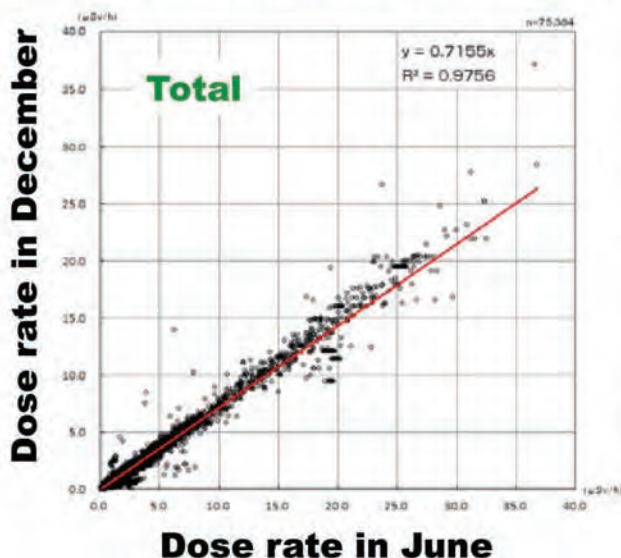

Collaboration with IRSN

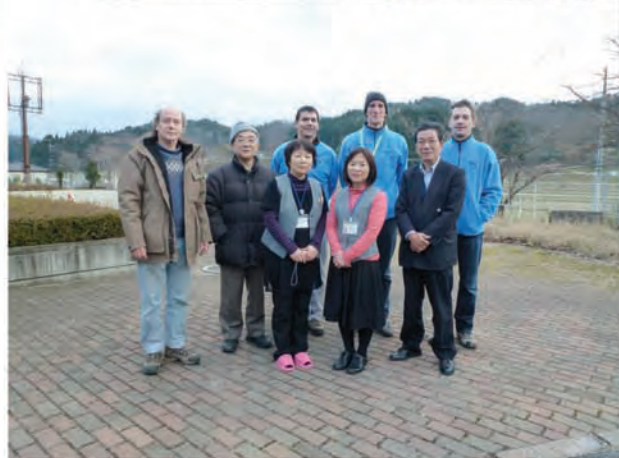

3. Air-borne survey maps

- Measurement of gamma-ray spectrum and GPS data per every second on a flying helicopter
- Conversion of aerial data to those on the ground using data from in situ spectrometry on the ground
- Survey over eastern regions in Japan

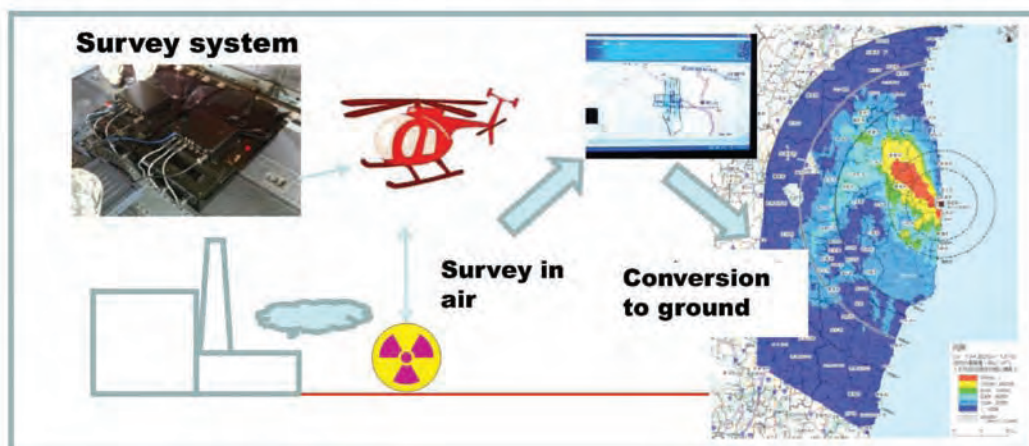

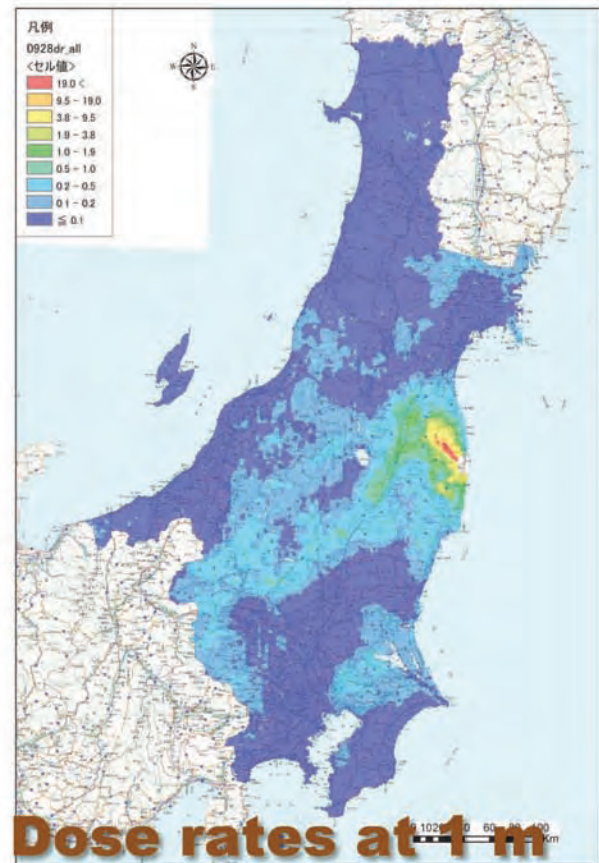
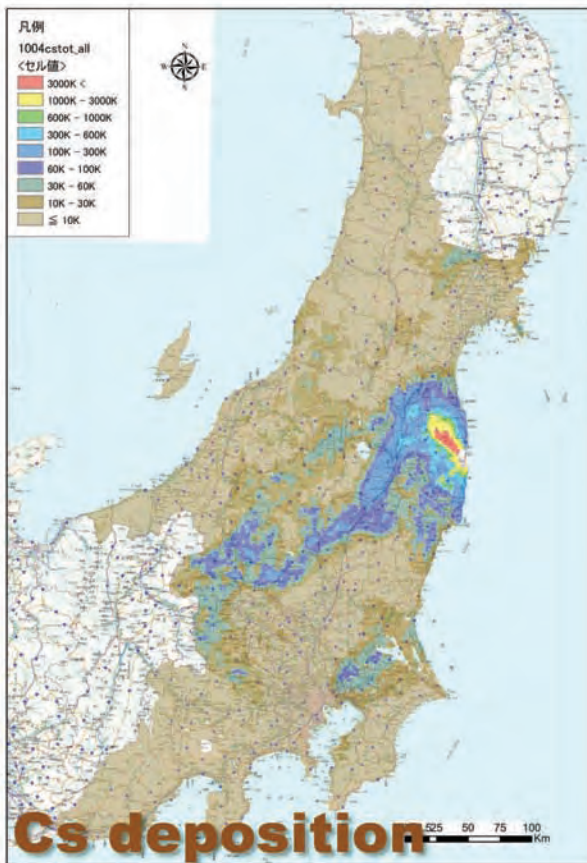

Contents

- I. Monitoring and mapping around the Fukushima nuclear site
- II. Roadmap and activities for environmental decontamination

Decontamination Roadmap

1. Act on Special Measures Concerning Handling of Environment Pollution by Radioactive Material ...

- Jan. 1, 2012 : Full enforcement
- Ministry of the Environment (MOE) is responsible for decontamination and restoration of waste

2. New evacuation zones to be specified

3. Decontamination Roadmap (Jan. 26)

1) Short-term roadmap for the specific area

(current restricted zone and deliberate evacuation zone)

2) Roadmap for new evacuation zones

3) Specification of areas for the detailed investigation on contaminated conditions (more than $0.23 \mu\text{Sv/h}$)

Current regulation zones

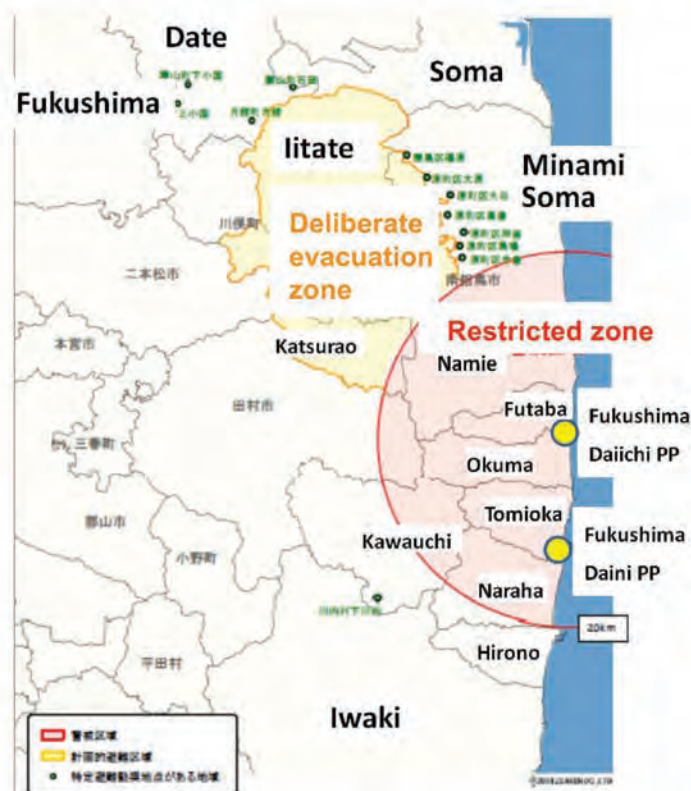

Short-term Decontamination Roadmap for the Specific Areas

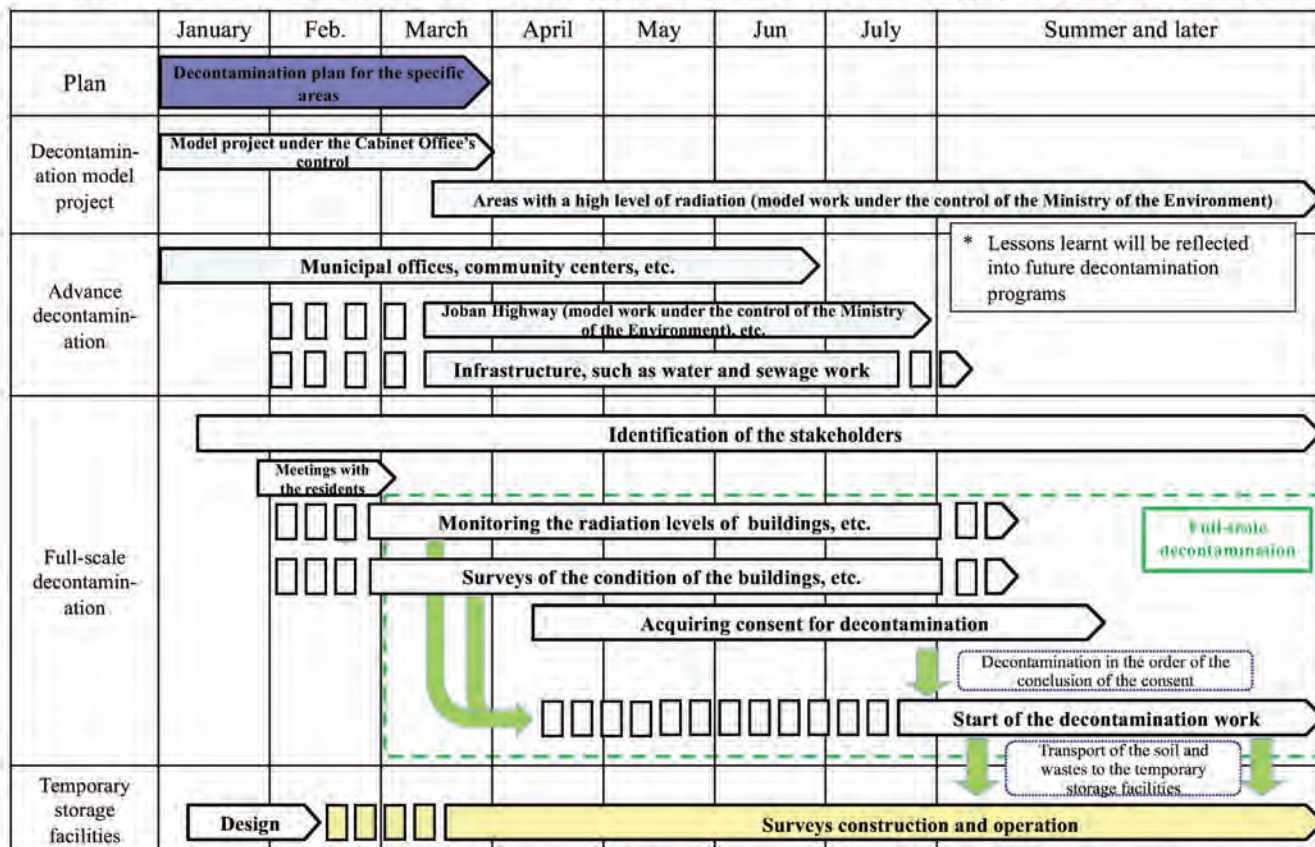

* The concrete decontamination procedures will be determined according to feature of each municipality.

Decontamination Roadmap for New Evacuation Zones

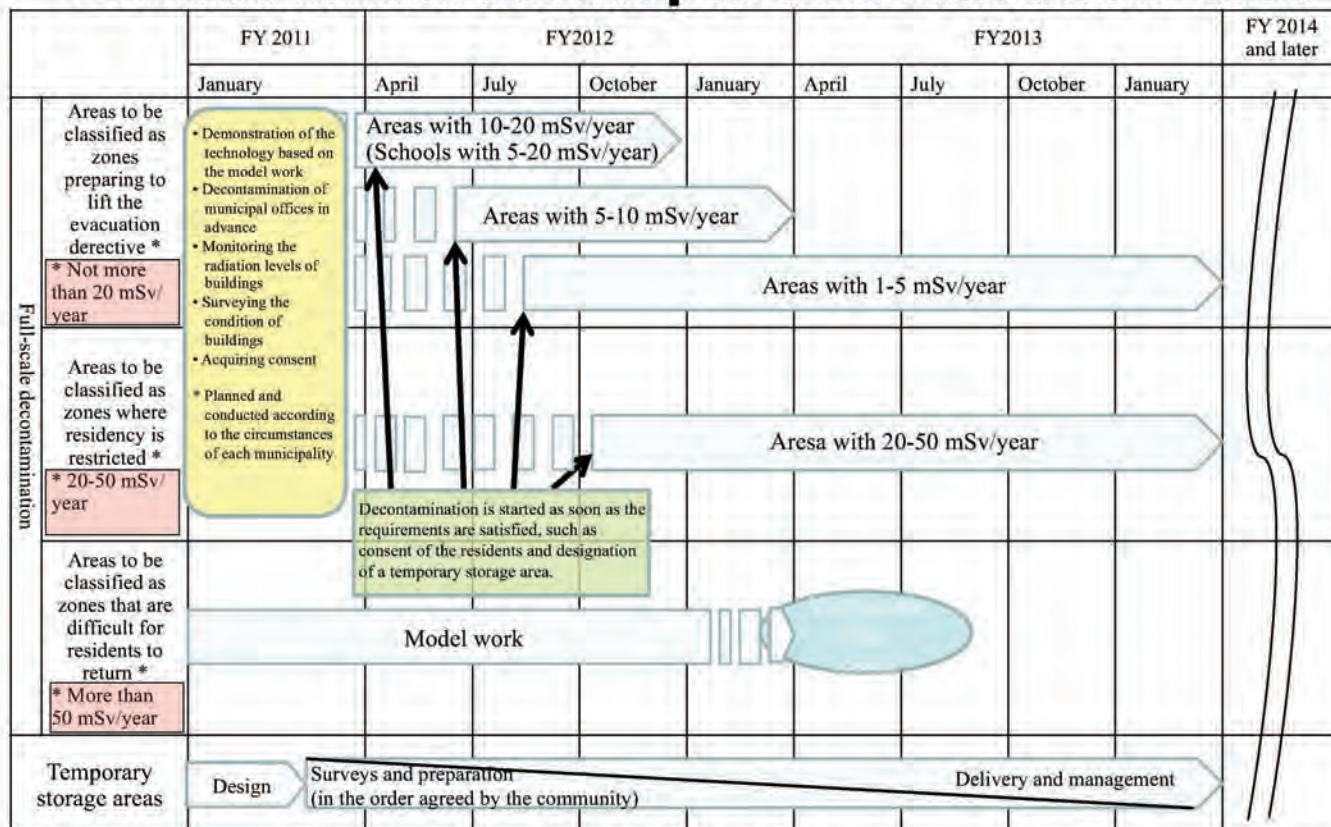

* Each municipal government specifies the concrete decontamination procedures.

* Technical knowledge obtained through the model work (Cabinet Office and the Ministry of the Environment) is applied to decontamination at the appropriate time.

Flowchart of Decontamination Procedures

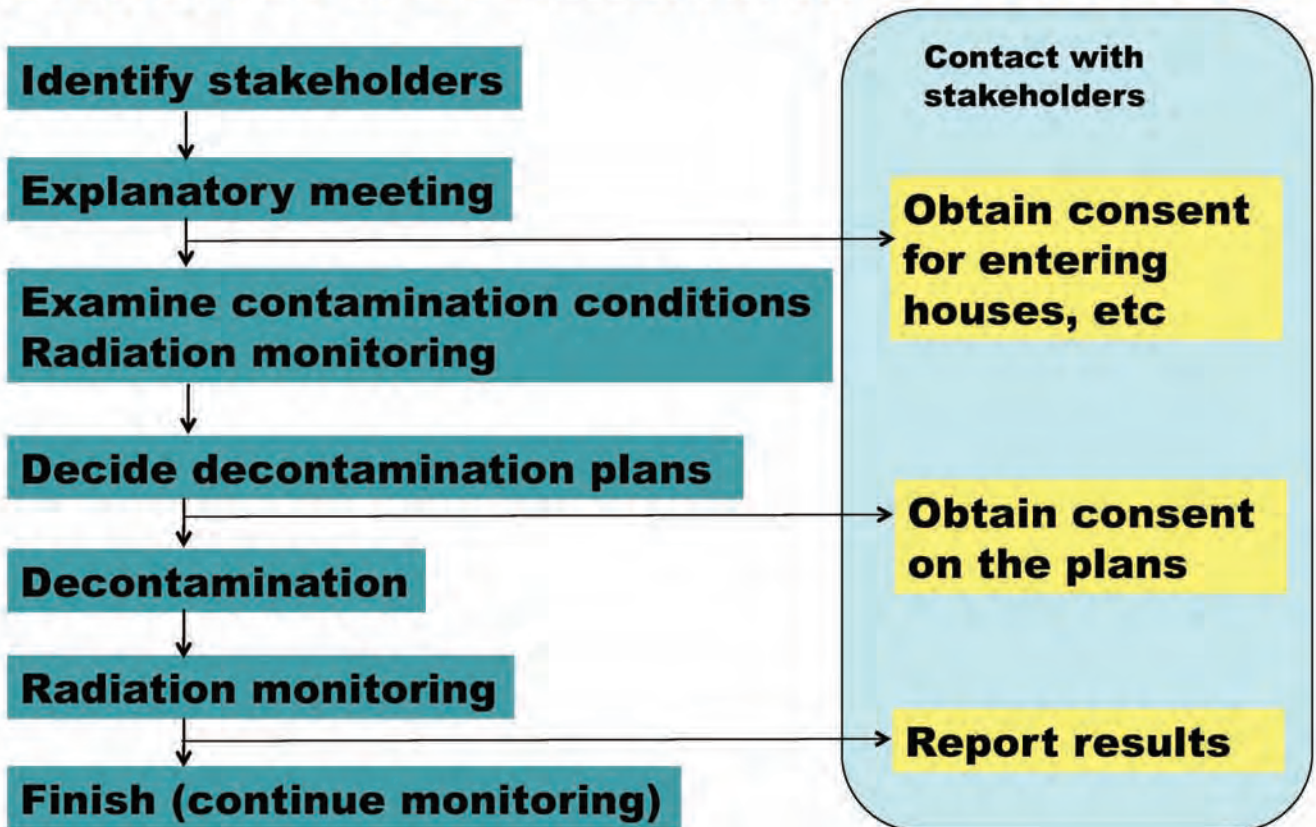

Decontamination Model Projects by JAEA

Demonstration of areal decontamination

- ◆ Decontamination at model areas in **Restricted / Deliberate Evacuation Zones**
19 sites in 12 municipalities, totaling 221 ha in size
- ◆ The model areas include;
 - ✓ **various components** such as forest, farmland, building, road and playground
 - ✓ **various dose rate levels**; high (> 100 mSv/y), intermediate (20 – 100), and low (5 – 20)
- ◆ Evaluation of efficiency, production of wastes, cost, safety.

R & D of decontamination technologies

- ◆ 25 proposals funded for improved/innovative decontamination technologies
- ◆ Required in situ operation
- ◆ Evaluation of efficiency, generation of wastes, cost, safety.

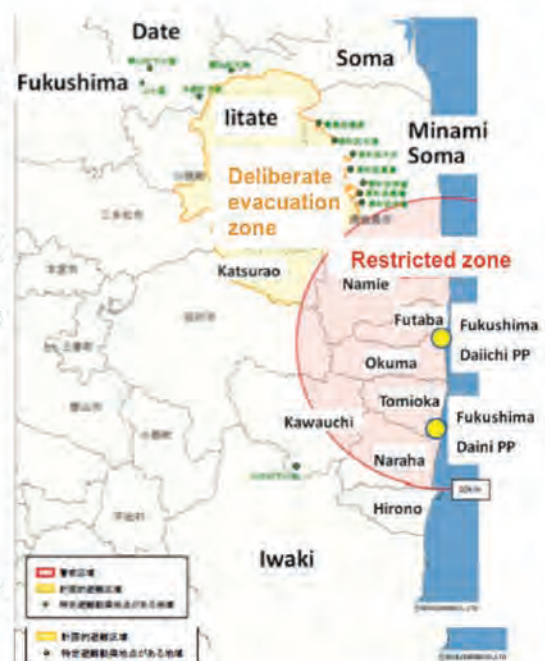

Demonstration of decontamination at model areas

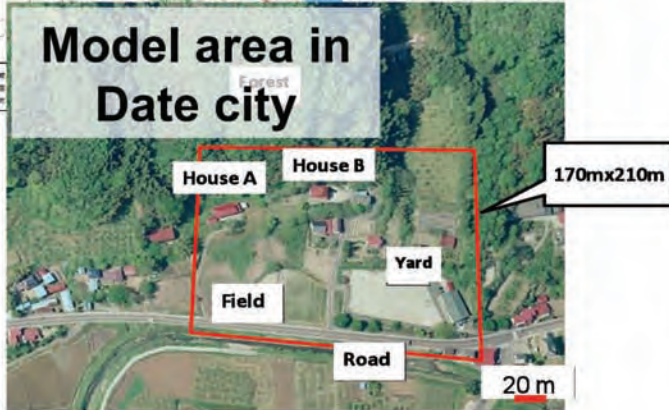
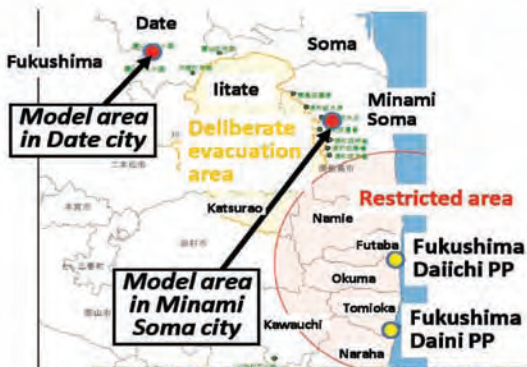

Radiation survey (whole area to be remediated)

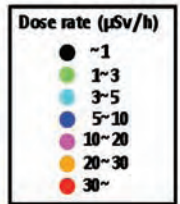
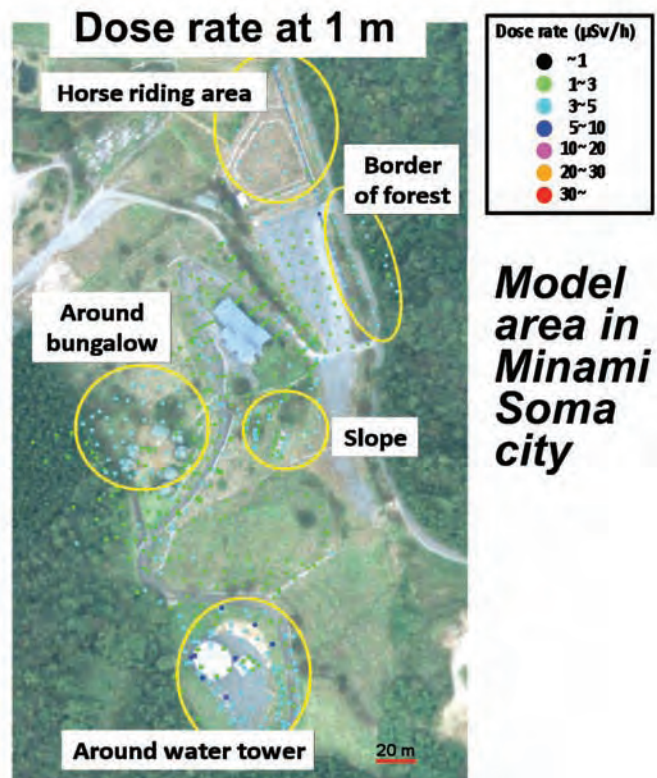
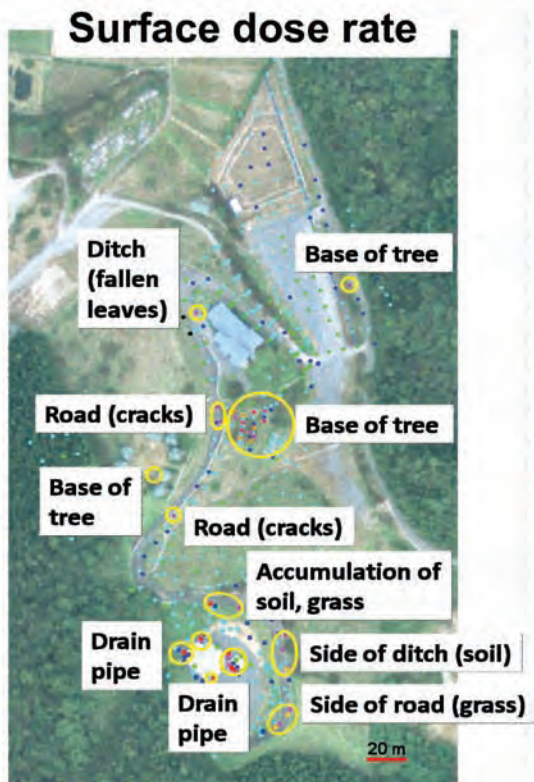

Model area in Minami Soma city

Estimation of dose rate reduction due to extension of remedial area

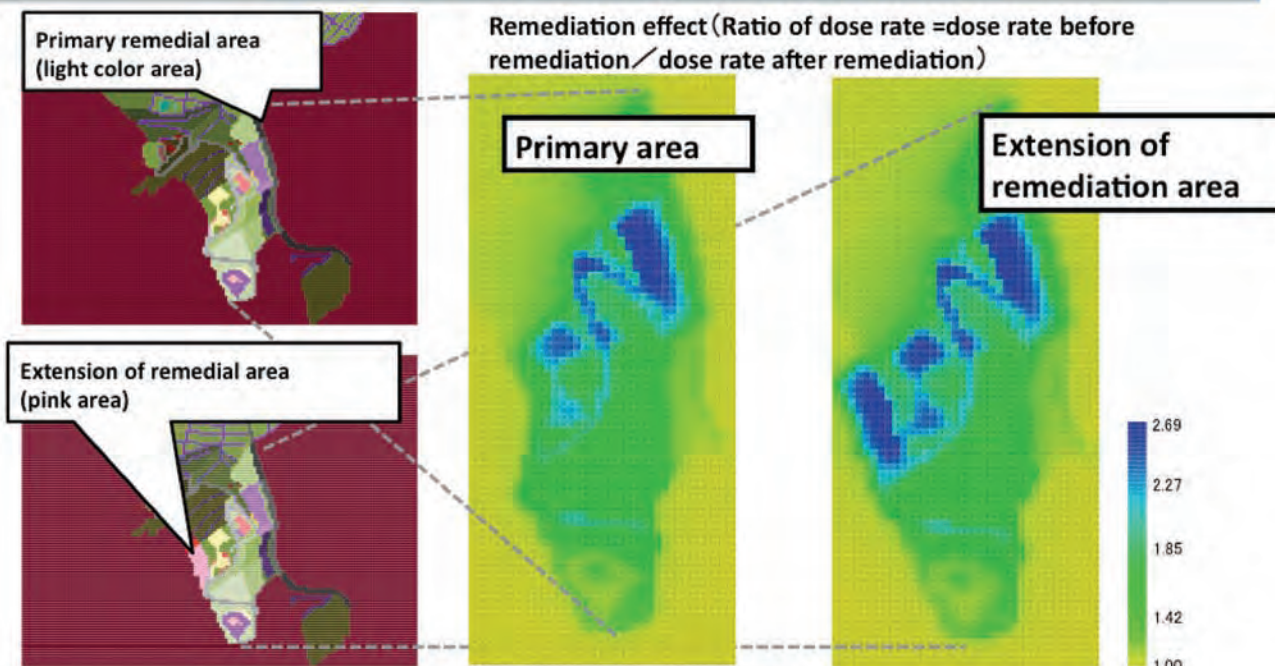

Remediation planning to select appropriate remedial areas before remedial actions using a calculation tool to estimate dose rate reduction due to extension of remedial area

Trial of remedial actions for forest



Bird's-eye view of Trial Area

The trial area is divided into 3 zones. Dimension of the zones are 10m wide and 10m length, respectively.



- Following remedial items were examined in every remedial zone. 1) weeding, 2) removal of fallen leaves, 3) removal of leaf mold.
- Finally, branches up to 4m height were cut off from the trees on forest boundary.
- Surface (at 1cm height) and ambient (at 1m height) dose rates were measured in the remedial zone and at forest boundary after carrying out every remedial item.

Dose rates after remedial items in each zone (μSv/h)

	Before remediation		remedial items					
			weeding		removal of fallen leaves		removal of leaf mold	
	surface	1 m	surface	1 m	surface	1 m	surface	1 m
Zone 1	3.4	2.5	3.5	2.5	2.8	2.5	1.6	1.8
Zone 2	3.3	2.7	3.2	2.5	2.4	2.3	1.7	1.7
Zone 3	3.1	2.5	3.2	2.4	2.5	2.2	1.6	1.4

After removal of leaf mold, surface and 1m dose rates were decreased 50% and from 30% to 40% lower than the condition before remediation, respectively.

Ambient dose rates at forest boundary after remedial actions of every zone and cutting off branches (μSv/h)

	before remediation	after zone 1	after zone 2	after zone 3	cutting off branches
forest boundary	2.4	2.2	2.3	2.4	2.1

Dose rates were not significantly decreased because of influence of contaminated materials around the trial area

Decontamination Pilot Projects: Building

◆ high pressure water washing



◆ removal of dirt, sludge, fallen leaves, etc. in roof gutters and street gutters



◆ removal with peeling agent

Decontamination Pilot Project: Concrete, Asphalt

◆ high pressure water washing



spin-jet washing



function recovery vehicle

◆ surface stripping



◆ blasting



iron shot blasting



ice blasting

Surface cleaning by high-pressure water

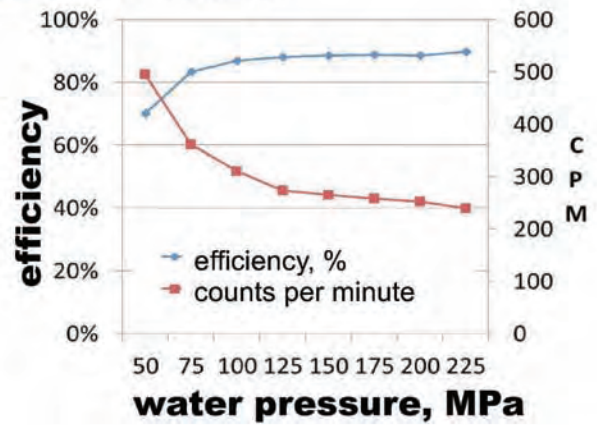
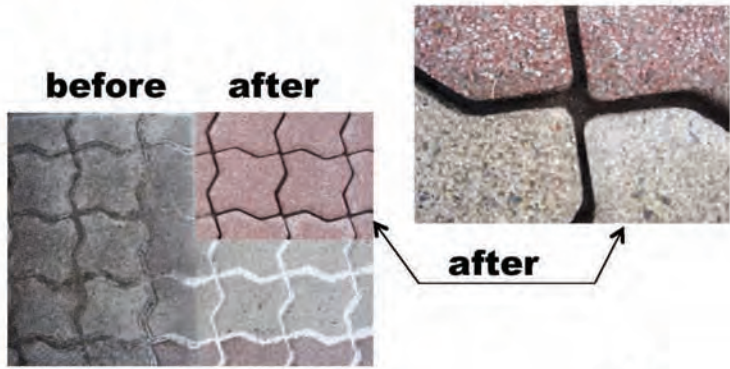

Decontamination Pilot Project: Farmland

◆ plow



◆ turf stripping



◆ topsoil removal



Decontamination Pilot Project: Trees, Forest

- ◆ clipping
- ◆ removal of leaf mold
- ◆ high pressure water washing
- ◆ weeding

◆ clipping



◆ removal of leaf mold



◆ high pressure water washing



Temporary storage for radioactive waste: mound type

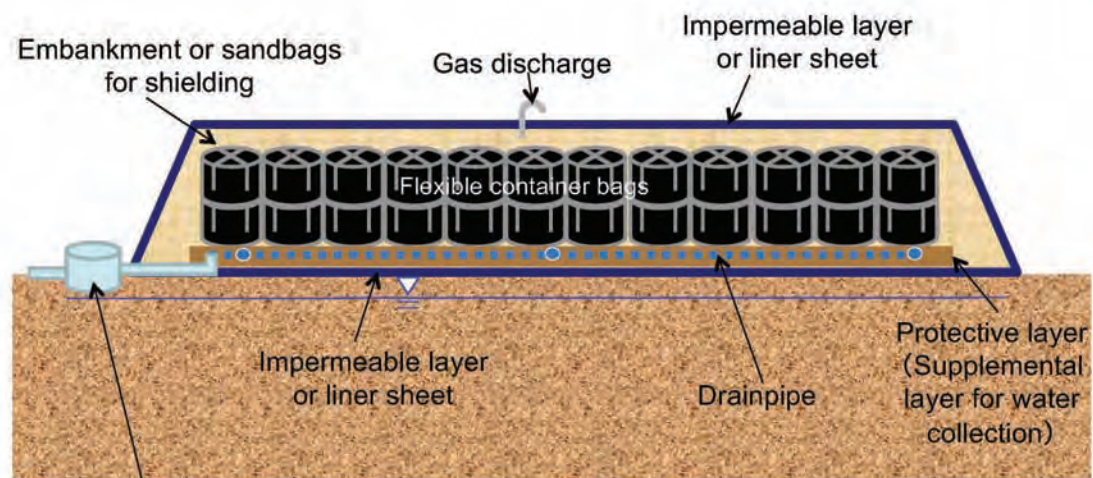

Plans on storage of radioactive waste

1. Temporary storage

- Storage for a short time
- Set up near decontaminated places

2. Intermediate storage facilities

- Storage for 30 years
- Planned to construct at three different locations in the Fukushima prefecture

3. Final storage facilities

- Permanent Storage
- Out of the Fukushima prefecture

Decrease of radioactive cesium in ground

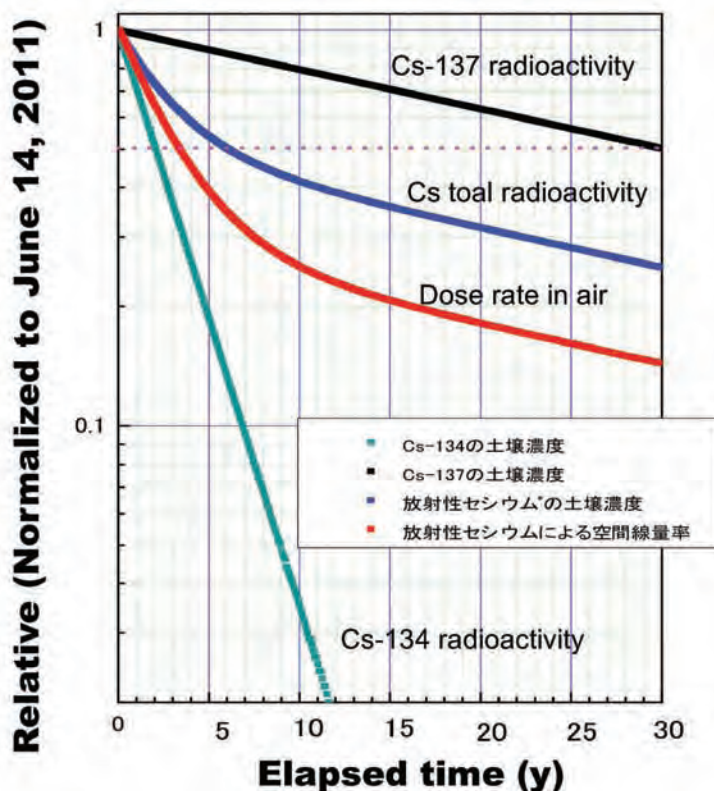



Nuclear and Industrial Safety Agency
Ministry of Economy, Trade and Industry

REVIEW OF THE LESSONS LEARNED FROM THE ACCIDENT

March, 2012
International Workshop on “One Year after Fukushima”,
Bologna, Italy

Toshihiro Bannai
Director, International Affairs Office
Nuclear and Industrial Safety Agency, Japan

NISA

Nuclear and Industrial Safety Agency

Thanks for Your Great Support and Cooperation

- Japan has received a wide array of support from the world. Japan would like to express its deepest gratitude.
- Japan will overcome this accident sharing latest information and lessons learned, and contribute to enhancing global nuclear safety.



The Accident at Fukushima Dai-ichi NPS

- The accident at Fukushima Dai-ichi NPS was caused by long lasting complete power loss due to common cause failure (CCF) of electrical equipment following tsunami, and insufficient provision against severe accident.
- It is temporarily rated at INES Level 7, and people where lived in the specific areas including those within 20 km radius from the site are still not able to return home.



The moment when tsunami attacked Fukushima Dai-ichi NPS (source: TEPCO)



General View of root causes of the Accident

CCF of electric equipment and insufficient severe accident provision were induced by following root causes:

- Too late or missed incorporation of new tsunami knowledge into hazard evaluation,
- The regulatory system not covering severe accident,
- Insufficient application of state-of-the-art technologies and international good practices to the regulatory programs.

New Nuclear Regulatory Organizations

Nuclear Regulatory Authority (NRA) will be established as an external organ of the Ministry of Environment (MOE) by:

- separating the nuclear safety regulatory function of NISA from METI and,
- unifying relevant functions of other ministries (Size: 500 Staff, 50 billion yen Budget).

NRA will implement new regulatory systems stipulated in amended laws, including:

- Regulation taking severe accidents into consideration.
- Regulation applying latest scientific/technical knowledge on safety issues to existing facilities. (backfitting)
- An operation limit of 40 years to deal with aged reactors

Current Status of Fukushima Dai-ichi NPP

Step 2 of the “Roadmap towards Settlement of the Accident at Fukushima Daiichi Nuclear Power Station, TEPCO” were completed (Dec 16th, 2011)

- Reactor : A condition so-called “Cold Shutdown”
 - ✓ Temperature of RPV bottom is, in general, below 100°C.
 - ✓ Release of radioactive materials from PCV is under control and public radiation exposure by additional release is being significantly held down. (Not exceed 1 mSv/y at the site boundary as a target.)
 - ✓ Mid-term Safety of Circulating Water Injection Cooling System
- Spent Fuel Pool : More stable cooling
 - ✓ Circulating Cooling System by installation of heat exchanger
- Radioactive Contaminated Water : Reduction of total amount
 - ✓ Full-fledged processing facilities
 - ✓ Desalination processing (reuse)
 - ✓ Storage
 - ✓ Mitigation of contamination in the ocean

Current Status of Fukushima Dai-ichi NPP

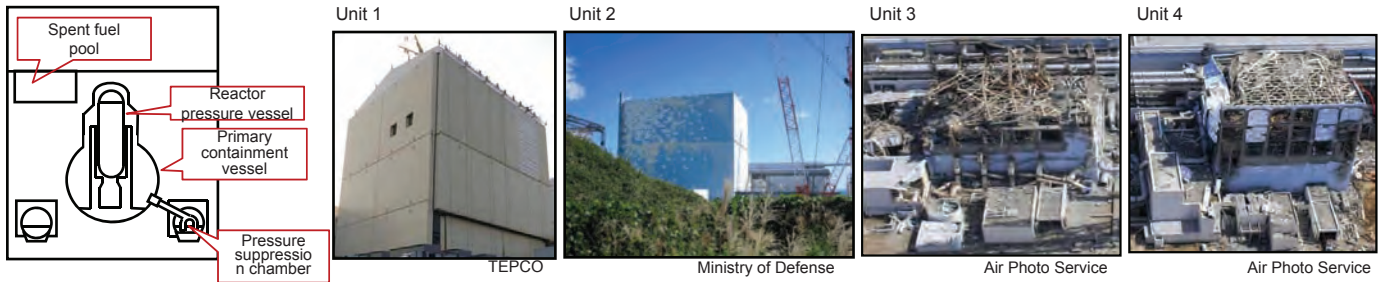

	Unit 1	Unit 2	Unit 3	Unit 4
Reactor Pressure vessel Temperature at reactor vessel bottom*	Circulating water injection cooling 24.3°C	Circulating water injection cooling 47.1°C	Circulating water injection cooling 51.4°C	No fuel
Primary Containment vessel Temperature of air in PCV*	Nitrogen injection 25.4°C	Nitrogen injection 54.3°C	Nitrogen injection 44.4°C	—
Fuel pool Temperature of pool water*	Circulation cooling 26.5°C	Circulation cooling 14.2°C	Circulation cooling 14.4°C	Circulation cooling 26°C
Highly-contaminated water in R/B and T/B**	14,100 m ³	22,000m ³	23,800 m ³	18,300 m ³

* As of 12:00 on February 24, 2012 ** As of February 21, 2012

Temperature Trends

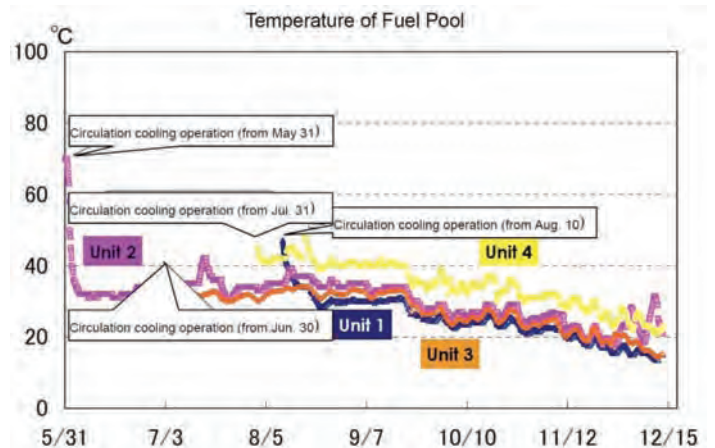
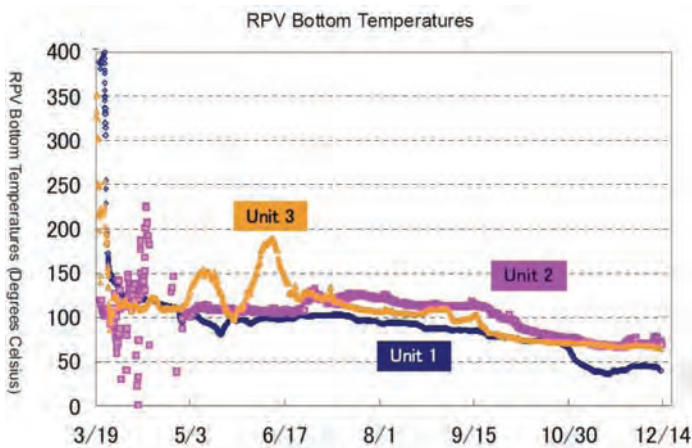

Result of Gas Sampling at PCVs Gas Control System

Nuclides	Concentration of sample (Bq/cm ³)	Detection limits of Unit 1 (Bq/cm ³)	Concentration of sample (Bq/cm ³)	Detection limits of Unit 3 (Bq/cm ³)	Concentration of sample (Bq/cm ³)	Detection limits of Unit 3 (Bq/cm ³)
	Unit 1 (Sampled on Mar. 8, 2012) Gas vial container		Unit 2 (Sampled on Mar. 7, 2012) Gas vial container		Unit 3 (Sampled on Mar. 1, 2012) Gas vial container	
I-131	N.D.	1.3×10^{-1}	N.D.	1.2×10^{-1}	N.D.	1.3×10^{-1}
Cs-134	3.5×10^{-1}	3.0×10^{-1}	5.9×10^{-1}	3.0×10^{-1}	4.0×10^{-1}	3.2×10^{-1}
Cs-137	5.5×10^{-1}	3.6×10^{-1}	8.1×10^{-1}	3.6×10^{-1}	7.2×10^{-1}	3.8×10^{-1}
Kr-85		2.5×10^{-1}	N.D.	2.5×10^{-1}	N.D.	2.5×10^{-1}
Xe-131m		2.9×10^0	N.D.	3.0×10^0	N.D.	3.3×10^0
Xe-133		2.4×10^{-1}	N.D.	2.7×10^{-1}	N.D.	2.2×10^{-1}
Xe-135		1.1×10^{-1}	N.D.	1.0×10^{-1}	N.D.	1.0×10^{-1}

N.D. : not detected

(Source: TEPCO)

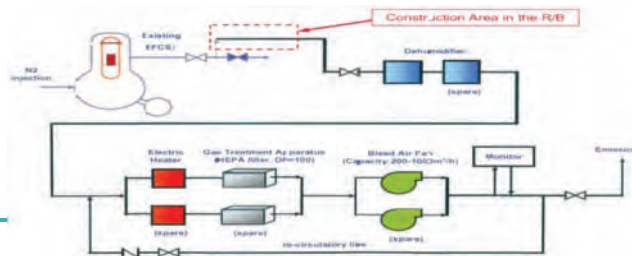

Trend of Amount of Accumulated Water

- Total amount of the accumulated water level has been decreased around the tentative target level of O.P. 3000 during STEP 2 and maintained.

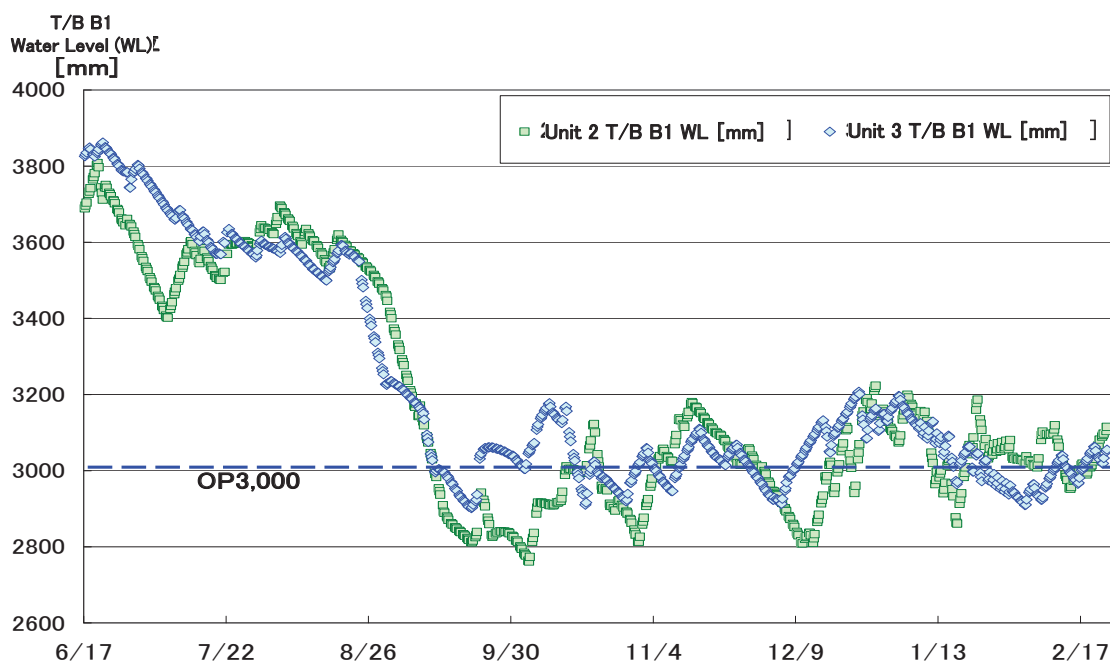

Release Rate of Radioactive Materials from PCVs of Units 1-3

- Current total release rate of Cesium 134 and 137 from PCVs of Units 1-3 is estimated to be approx. 0.01 billion Bq/h at the maximum. (1/77,000,000 of early stages of the accident)

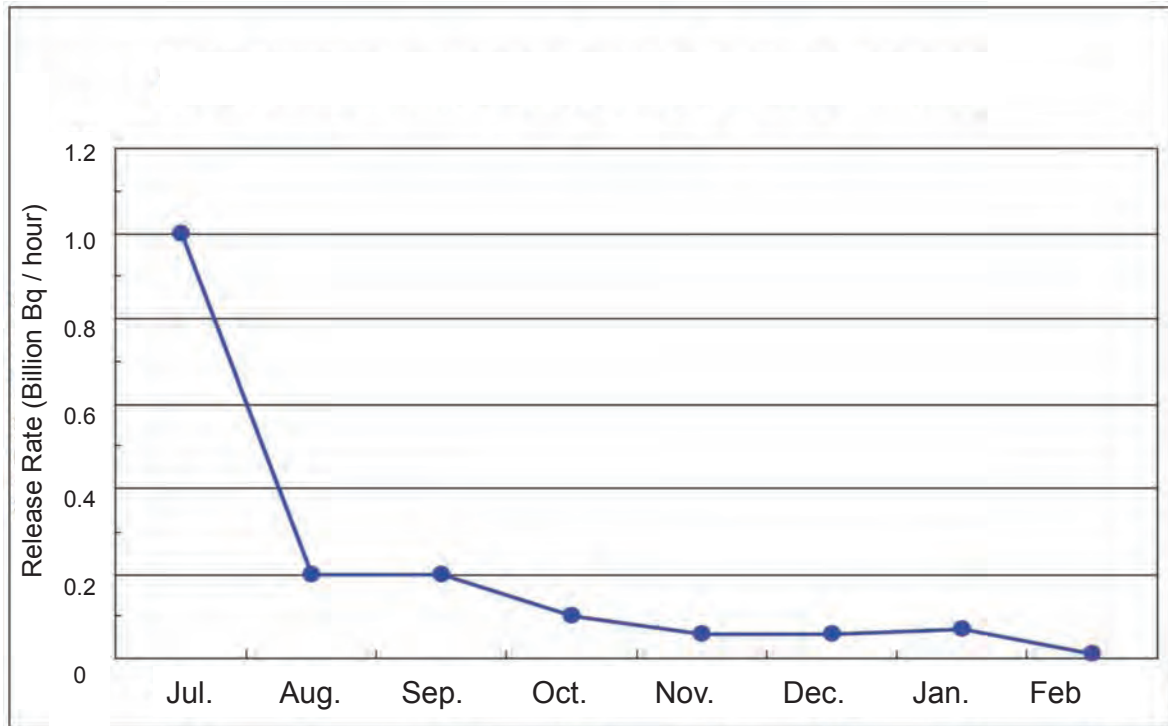

Installation of Reactor Building Cover (on Oct. 28, 2011)

- A cover was installed in the Unit 1 building to restraint release of radioactive materials.
- Rubble is being removed from the upper part of the reactor buildings for Units 3 and 4 before installation of the covers.



Construction of Water Shielding Wall

- A measure to prevent contamination of the **Ocean** via the underground water.

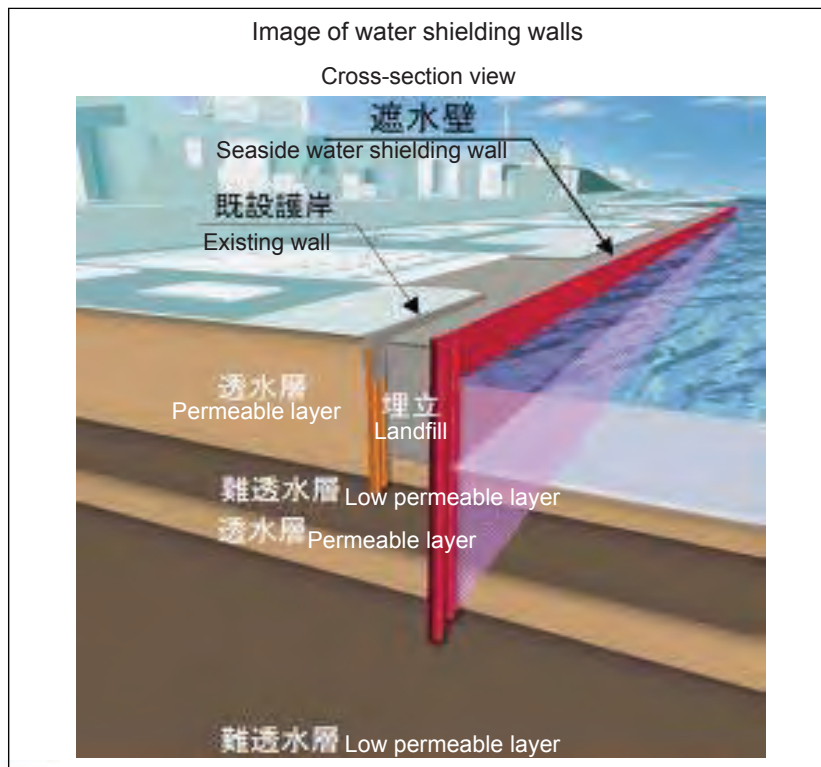

Start of Marine Soil Covering Construction at Inside Port

- High concentrated radioactive materials were detected from marine soil sampled at inside of the port
- To prevent contamination of the ocean outside of the port, marine soil in front of the intake canal is planned to be covered with solidified soil.

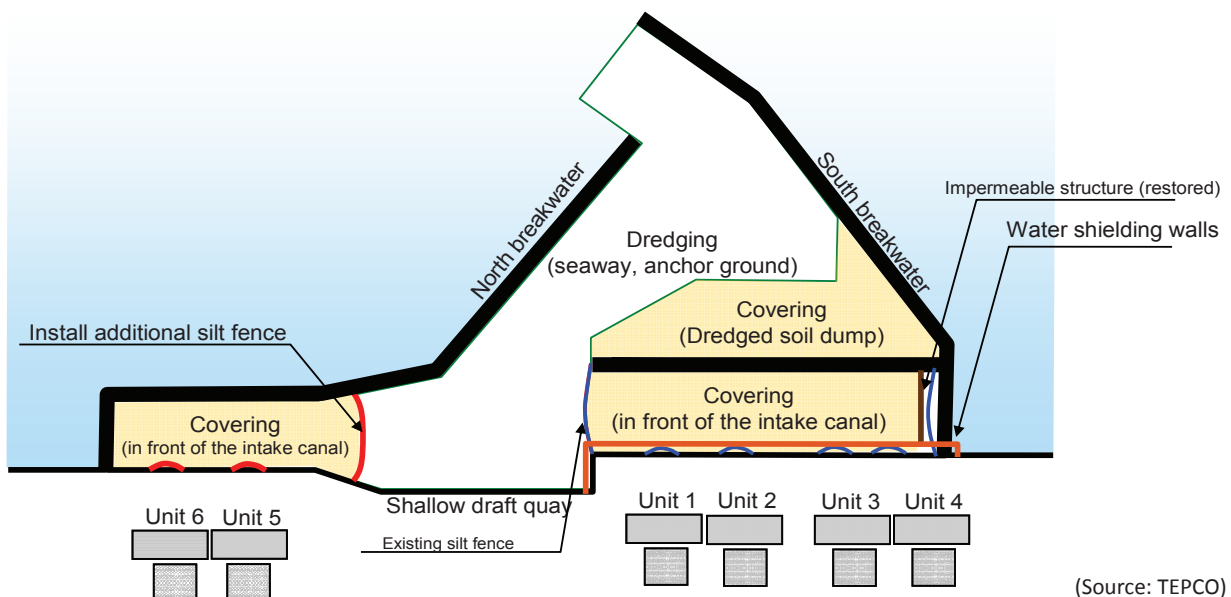

(Source: TEPCO)

Prepare for Fuel Removal from SFP of Unit 4

- Fuel removal are planned to be initiated in autumn 2013.
- Currently Rubble is being removed to prepare for the relevant works.
- Construction of covering structure will be initiated in spring 2013.

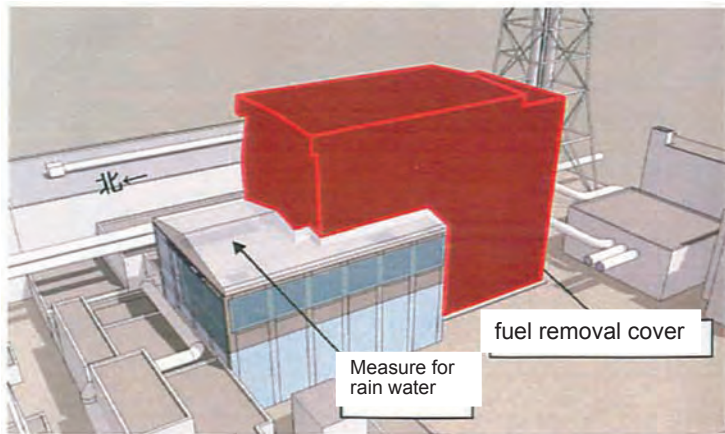

Building image of fuel removal cover

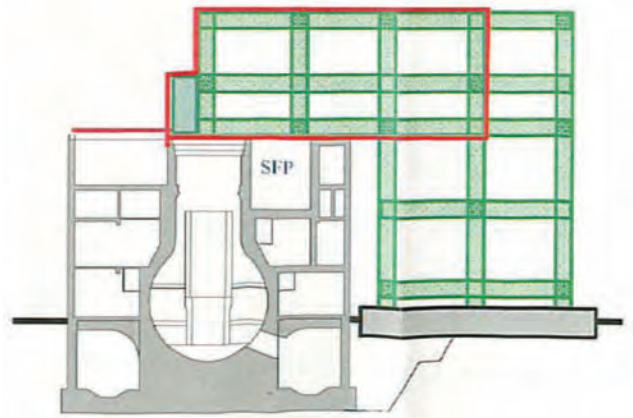

Cross-section diagram

(Source: TEPCO)

Info. Sharing & Peer Reviews through IAEA and OECD/NEA

(2011)

- May-Jun: IAEA Fact Finding Mission
- Jun: Report of the Japanese Government to the IAEA Ministerial Conference on Nuclear Safety
- Sep: Additional Report of the Japanese Government (Second Report) to the IAEA
- Oct: IAEA Decontaminating Review Mission
IAEA IRRS Work Shop
International Symposium on Decontamination
- Nov: International Seminar on Stress Test

(2012)

- Jan: International Workshop on Nuclear Safety Regulation
IAEA Stress Test Review Mission
- Mar: IAEA International Expert Meeting
- Aug: Extraordinary Meeting on CNS
- Dec: The Fukushima Ministerial Conference on Nuclear Safety

(TBD)

- IAEA Decommissioning Review Mission

Lessons Learned So Far

–28 Lessons in Japanese Government’s Report to IAEA–

- Category 1
Prevention measures against a severe accident (8 items)
- Category 2
Mitigation measures against a severe accident (7 items)
- Category 3
Responses to the nuclear accident (7 items)
- Category 4
Safety infrastructure (5 items)
- Category 5
Safety culture



First Report in June 2011



Additional Report in September 2011



Mr. Goshi HOSONO, Minister of State for the Nuclear Power Policy and Administration delivered a statement at General Conference on 19 Sep. 2011.

Lessons Learned So Far

–16 Lessons in IAEA Fact Finding Mission’s Report–

- Lesson 1: Considering external natural hazards
- Lesson 2, 3: Providing any necessary equipment for severe accident management
- Lesson 4, 5: Housing the Emergency Response Centres
- Lesson 6: Taking account of the potential unavailability of instruments, lighting, power and abnormal conditions
- Lesson 7: Pooling experienced personnel adequately
- Lesson 8: Revisiting the risk and implications of hydrogen explosions
- Lesson 9: Providing adequate diversity for essential safety functions
- Lesson 10: Providing hardened systems, communications and sources of monitoring equipment
- Lesson 11: Making off-site emergency preparedness and response even more effective
- Lesson 12: Introducing concepts of ‘deliberate evacuation’ and ‘evacuation-prepared area’ for effective long term countermeasures
- Lesson 13: Taking advantage of the data and information generated from the Fukushima accident
- Lesson 14: Organizing appropriately and with well led and suitable trained staff
- Lesson 15: Establishing effective on-site radiological protection in severe accident conditions
- Lesson 16: Ensuring regulatory independence



IAEA Action Plan

1. Safety assessments in the light of the accident at TEPCO's Fukushima Daiichi Nuclear Power Station
2. IAEA peer reviews
3. Emergency preparedness and response
4. National regulatory bodies
5. Operating organizations
6. IAEA Safety Standards
7. International legal framework
8. Member States planning to embark on a nuclear power programme
9. Capacity Building
10. Protection of people and the environment from ionizing radiation
11. Communication, information dissemination and analyze relevant technical aspects
12. Research and development



Stress Test in Japan (as IAEA AP #1)

Objectives

Carry out safety assessment to ensure public/residents relief and confidence in improved safety of nuclear power plants, according to new procedure/rule and referring to stress tests conducted in European countries as references.

Overview

- **Primary assessment: (Decision on whether to restart operations at nuclear power stations currently suspended for the purpose of regularly scheduled checks)**
Evaluate safety margins of structures, systems and components important to safety to endure the events beyond design bases, for nuclear power plants under periodic inspection and ready for start-up.
- **Secondary assessment: (Decision on whether to continue or halt operations of nuclear power stations that are currently in operation)**
Conduct comprehensive safety assessment for all nuclear power plants including those in operation and those subject to primary assessment, considering the status of stress tests in European countries and progress in investigation by the Investigation and Verification Committee on the Accident.

" Confirmation of the Safety of Nuclear Power Stations in Japan " (July 11)

Events Assessed and Safety Margin Assessment Process

Assess the safety margins (overall system margins) from the occurrence of events beyond design bases (earthquake and tsunami), through functional loss of individual component and damages to redundant safety measures, finally to core damage.

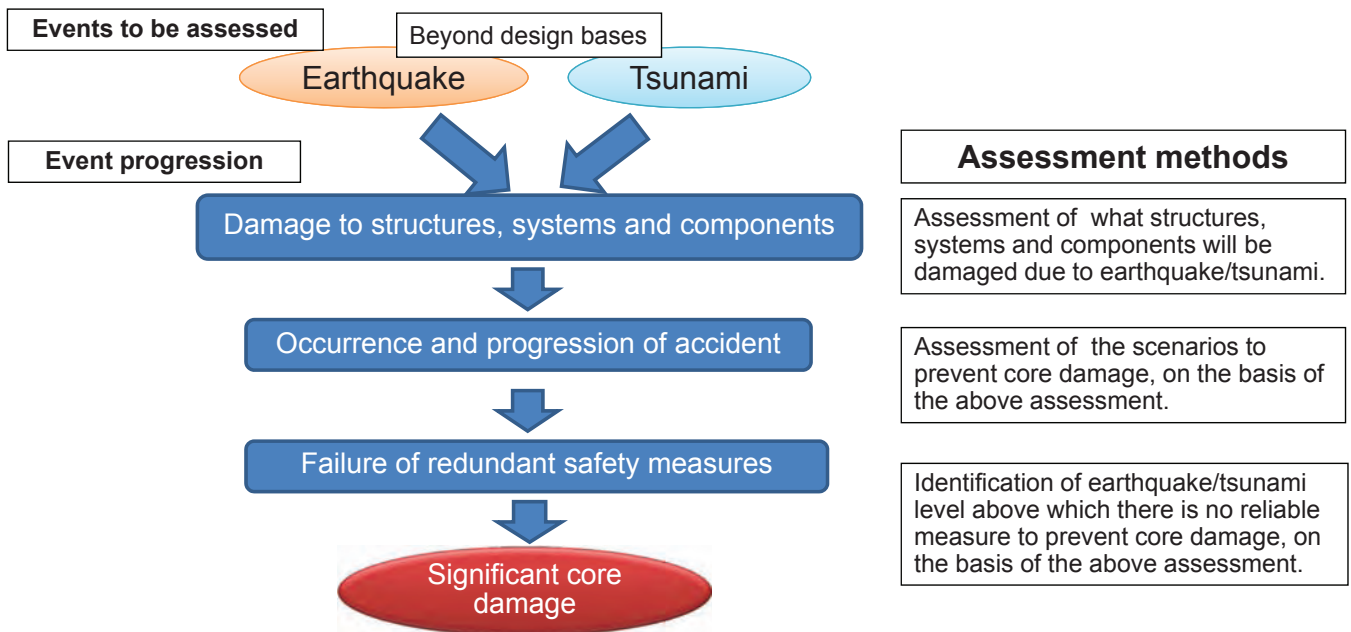

2.-III.-a-3. Review Process of Stress Test (Primary Assessment)

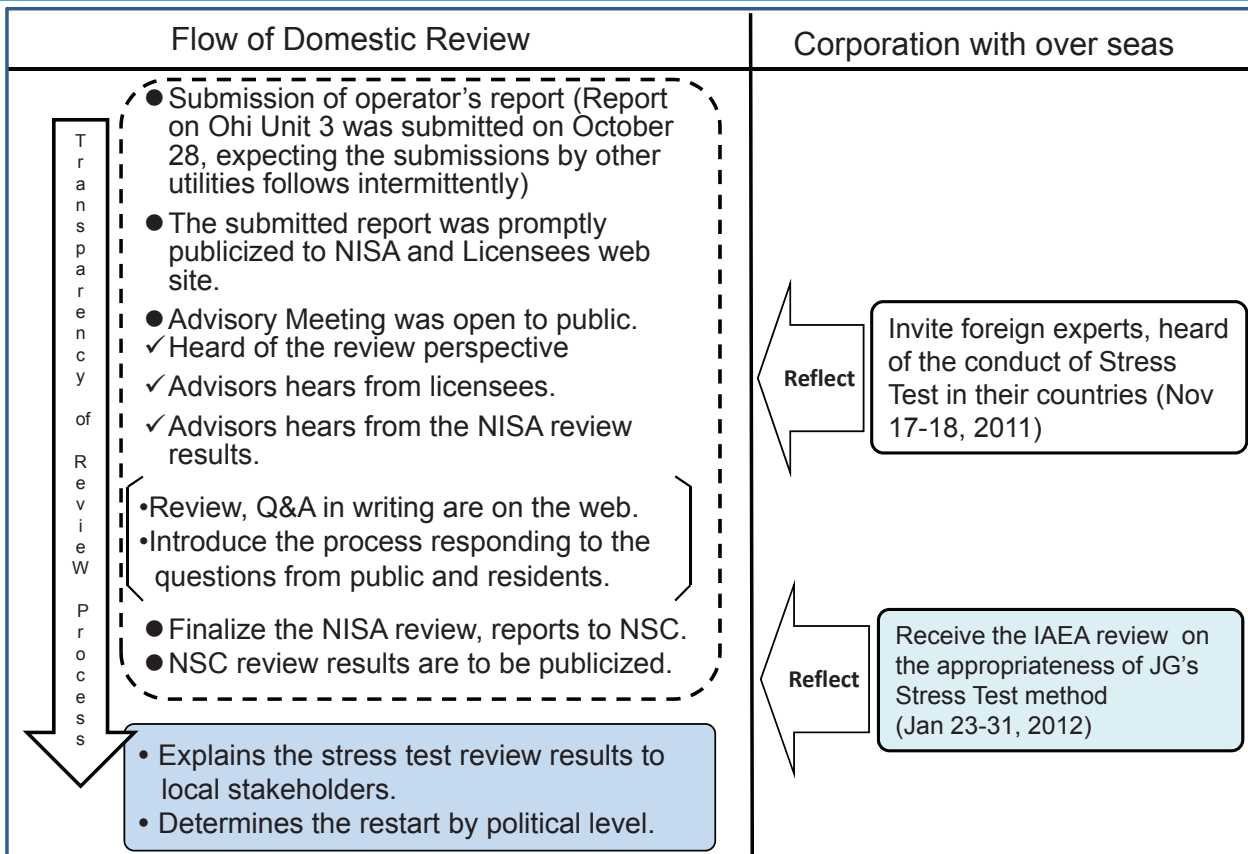

2.-III.-a-3. Review Process of Stress Test (Primary Assessment) (cont'd)

(As of February 24, 2012)

Licensee	Power station (Unit)	Date of report on primary evaluation	Date of NISA's evaluation completion	Date of report to NSC	Date of NSC's confirmation completion
Kansai Electric Power Co.	Ohi Power Station (Unit 3)	Oct. 28, 2011	Feb. 23, 2012	Feb. 23, 2012	—
Shikoku Electric Power Co.	Ikata Power Station (Unit 3)	Nov. 14, 2011	Evaluation under way	—	—
Kansai Electric Power Co.	Ohi Power Station (Unit 4)	Nov. 17, 2011	Feb. 23, 2012	Feb. 23, 2012	—
Hokkaido Electric Power Co.	Tomari Power Station (Unit 1)	Dec. 7, 2011	Evaluation under way	—	—
Kyushu Electric Power Co.	Genkai Nuclear Power Station (Unit 2)	Dec. 14, 2011	Evaluation under way	—	—
Kyushu Electric Power Co.	Sendai Nuclear Power Station (Unit 1)	Dec. 14, 2011	Evaluation under way	—	—
Kyushu Electric Power Co.	Sendai Nuclear Power Station (Unit 2)	Dec. 14, 2011	Evaluation under way	—	—
Kansai Electric Power Co.	Mihama Power Station (Unit 3)	Dec. 21, 2011	Evaluation under way	—	—
Japan Atomic Power Co.	Tsuruga Power Station (Unit 2)	Dec. 27, 2011	Evaluation under way	—	—
Hokkaido Electric Power Co.	Tomari Power Station (Unit 2)	Dec. 27, 2011	Evaluation under way	—	—
Tohoku Electric Power Co.	Higashidori Nuclear Power Station (Unit 1)	Dec. 27, 2011	Evaluation under way	—	—
Kansai Electric Power Co.	Takahama Power Station (Unit 1)	Jan. 13, 2012	Evaluation under way	—	—
Tokyo Electric Power Co.	Kashiwazaki-Kariwa Nuclear Power Station (Unit 1)	Jan. 16, 2012	Evaluation under way	—	—
Tokyo Electric Power Co.	Kashiwazaki-Kariwa Nuclear Power Station (Unit 7)	Jan. 16, 2012	Evaluation under way	—	—
Kansai Electric Power Co.	Ohi Power Station (Unit 1)	Jan. 27, 2012	Evaluation under way	—	—
Hokuriku Electric Power Co.	Shika Nuclear Power Station (Unit 2)	Feb. 1, 2012	Evaluation under way	—	—

- Currently 54 units of nuclear power plants are in operation. (The Units 1~4 at the TEPCO Fukushima Daiichi Nuclear Power Station were decided to be decommissioned .)
- 2 units (Tomari Power Station (Unit 3) and Kashiwazaki-Kariwa Nuclear Power Station (Unit 6)) are operating and 48 units are in stoppage.

2.-III.-b-1. New Safety Regulation (as IAEA AP #4)

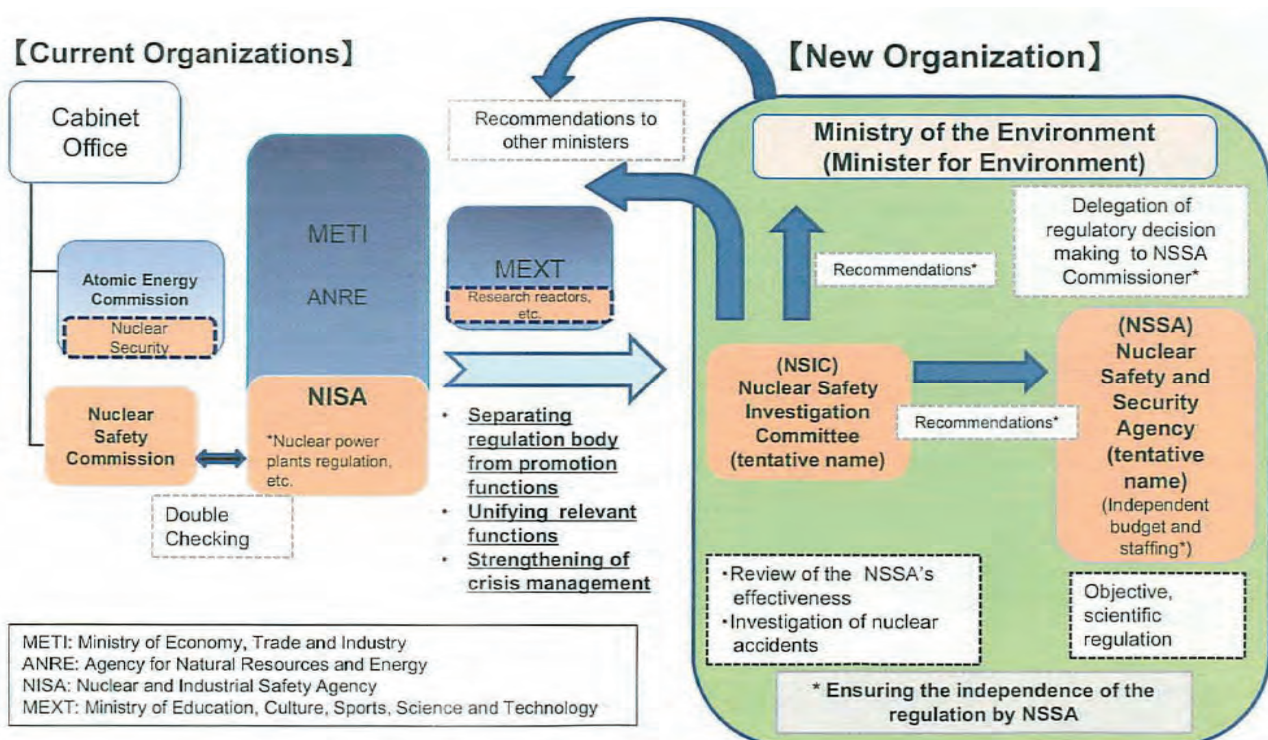

2.-III.-b-2. Reform of Japan’s Nuclear Safety Regulation

○Reform of the Atomic Energy Basic Act

Considering the international understanding of nuclear safety, the objective of nuclear safety in the use of nuclear energy, that is “to protect people and the environment from harmful effects of ionizing radiation,” will be clearly written in the Atomic Energy Basic Act.

○Reform of the Nuclear Reactor Regulation Law

1. Dealing with “the unexpected” - The new regulation takes severe accidents into consideration.
2. Regulation based on the latest knowledge - The new regulation applies latest scientific/technical knowledge on safety issues to existing facilities.(backfitting)
3. An Operational limit of 40 years will be introduced to ensure the safety of aged power reactors.
4. Specified licensee’s responsibility - a licensee’s responsibility to constantly improve the safety of its facilities
5. Thorough protection of the lives and health of citizens in case of nuclear disasters
6. Unification of legislation – Separation from the Electricity Business Act

2.-III.-c-1. Analysis of Relevant Technical Aspects (as IAEA AP #11)

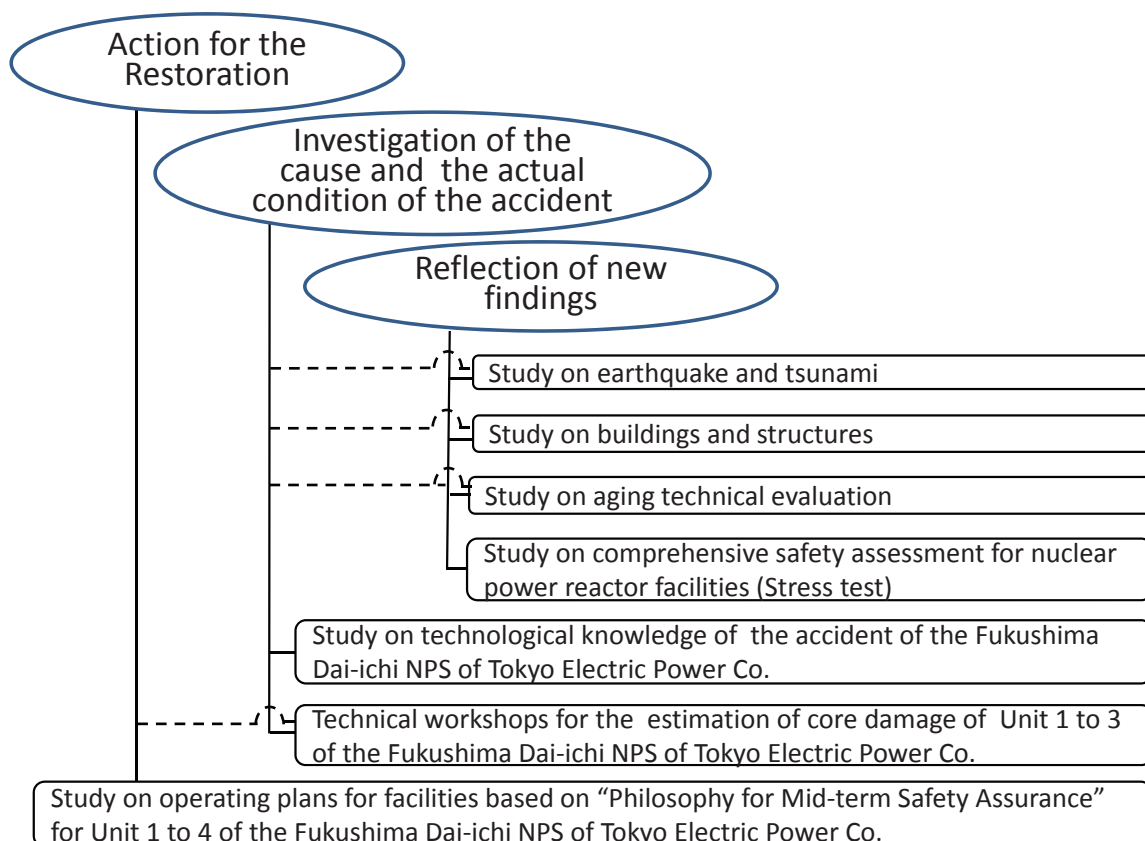

Comparison with other NPSs (damages by earthquake and tsunami)

	Fukushima Dai-ichi NPS	Fukushima Dai-ni NPS	Onagawa	Tokai Dai-ni	(Status of Fukushima Dai-ni, Onagawa and Tokai Dai-ni)
Seismic intensity (Observation point: city / town /village)	6 upper (Ohkuma Town, Futaba Town)	6 upper (Naraha Town, Tomioka Town)	6 lower (Onagawa Town)	6 lower (Tokai Village)	-
Max. acceleration on observation record (on basement) [Comparison with basic design earthquake ground motion (Ss)]	550 Gal (Unit 2 E-W direction) [Partially surpassed Ss]	305 Gal (Unit 1 Up-down direction) [Lower than Ss]	607 Gal (Unit 2 S-N direction) [Partially surpassed Ss]	225 Gal (E-W direction) [Lower than Ss]	-
Elevation of site* (Subsidence due to earthquake is not considered)	Units 1-4: 10m Units 5-6: 13m	12m	14.8m	8m	-
Estimated Tsunami height* (Estimate using the methods of Society of Civil Engineering, as of 2002)	5.4-5.7m	5.1-5.2m	13.6m	5.75m	-
Tsunami run-up height*	Units 1-4: 14-15.5m Units 5-6: 13-14.5m	7.0-7.3m (Only south side of Unit 1 building: 15.3-15.9m)	13.8m	6.2m	-
Power receiving status from (off-site) power cable	Loss of all circuits (out of 6 circuits)	1 circuit available (out of 4 circuits)	1 circuit available (out of 5 circuits)	Loss of all circuits (out of 3 circuits)	-
Emergency generator (Installation location)	Units 1-5: × (Water cooling) Units 2&4: × (Air cooling) Unit 6: ○ (1 unit: Air cooling) × (2 units: Water cooling)	Units 1& 2: × Unit 3: ○ (2/3) Unit 4: ○ (1/3) (All water cooling)	Unit 1: ○ Unit 2: ○ (1/3) Unit 3: ○ (All water cooling)	○ (2/3) (All water cooling)	AC power (Emergency power supply) was available. → Core cooling was possible.
	T/B basement (Sea side) Operation auxiliary common facility on the 1st floor DG building	Reactor building basement (Land side)	Reactor building basement (Land side)	Reactor building basement (Land side)	Emergency generator is installed in reactor building.
Sea water pump motor (Pump location / height)	Totally soaked	Partially soaked	Partially soaked	Partially soaked	Pumps were partially available and functioned.
	Outdoor O.P: 4m	Indoor O.P: 4.2m	Partially Outdoor O.P: 3m	Outdoor T.P: 0.8m	No specific difference (Height of tsunami that attacked Fukushima Dai-ichi NPS was enormous.)
Tools arranged for power supply	Power source car (could not be connected)	Power source car was used partially	Because off-site power supply by power cable or emergency diesel generator survived, power source car was not necessary.		

Progress of Accident (Outline of Accident Development Common to Units 1-3)

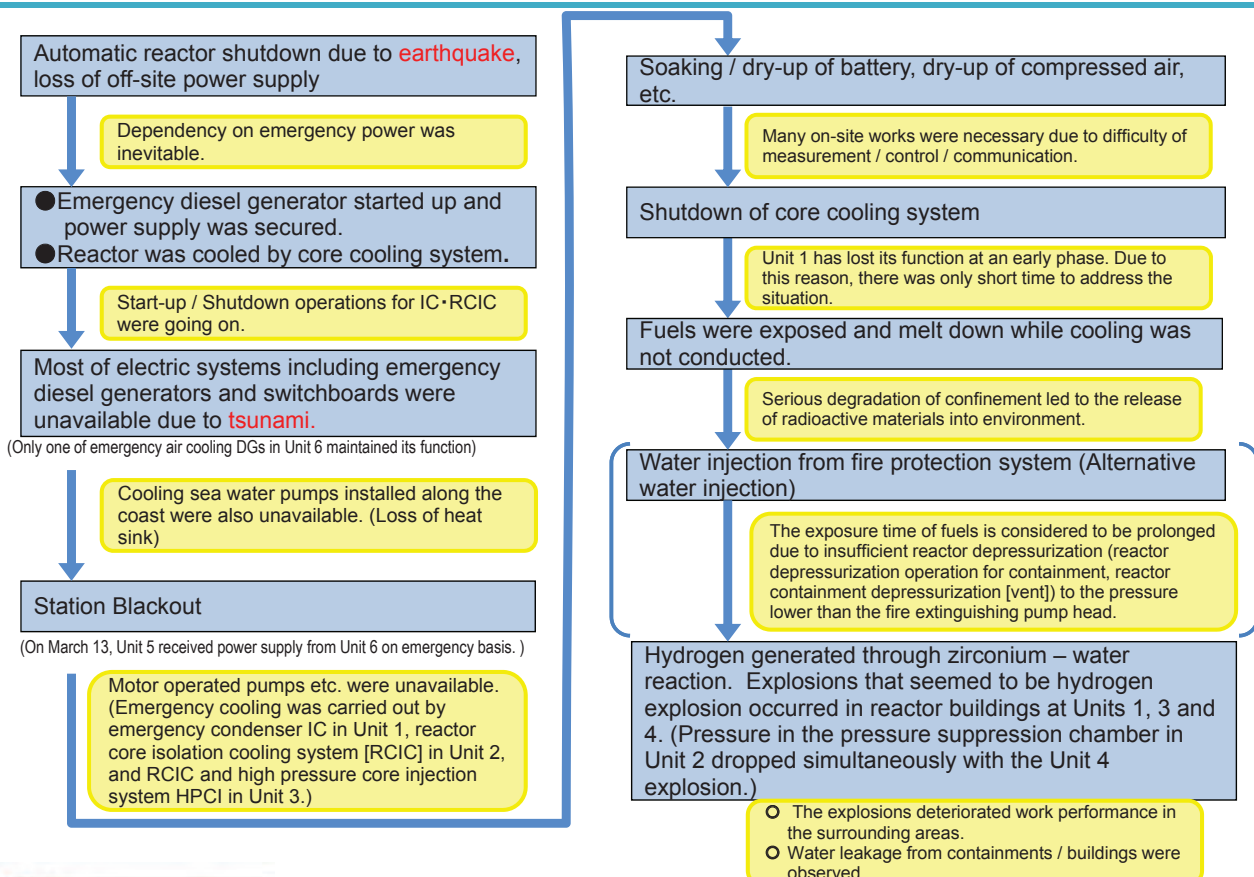

Technical Knowledge Learned and Direction of Countermeasures

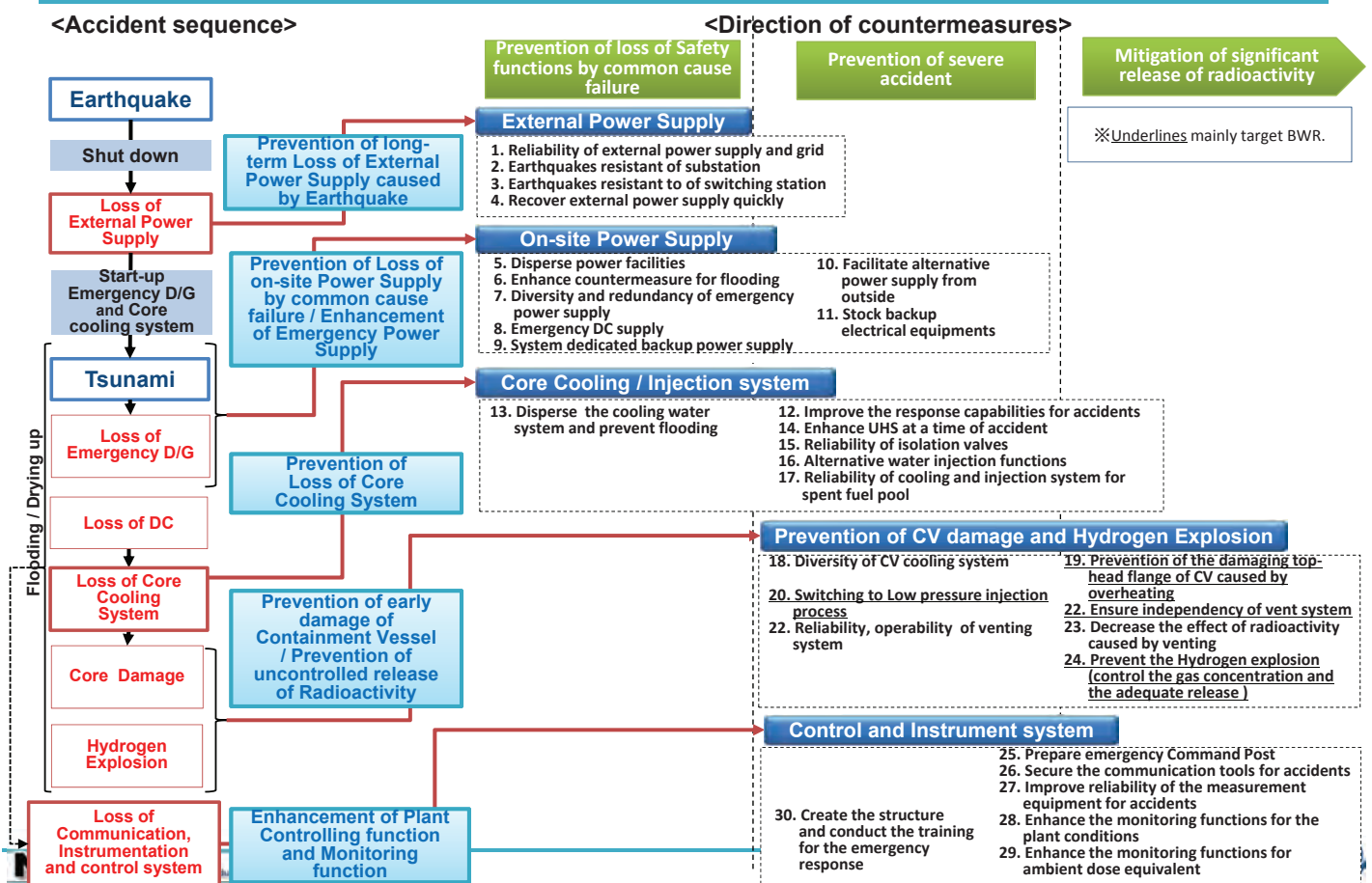

Operating Conditions of Isolation Condenser (IC) of Unit 1

- Due to loss of DC power supply after tsunami, the indication of the valve status (open or close) went off, and the IC became uncontrollable.
- Due to loss of DC power supply, the interlock of the isolation valve in fail-safe mode closed the IC valves.

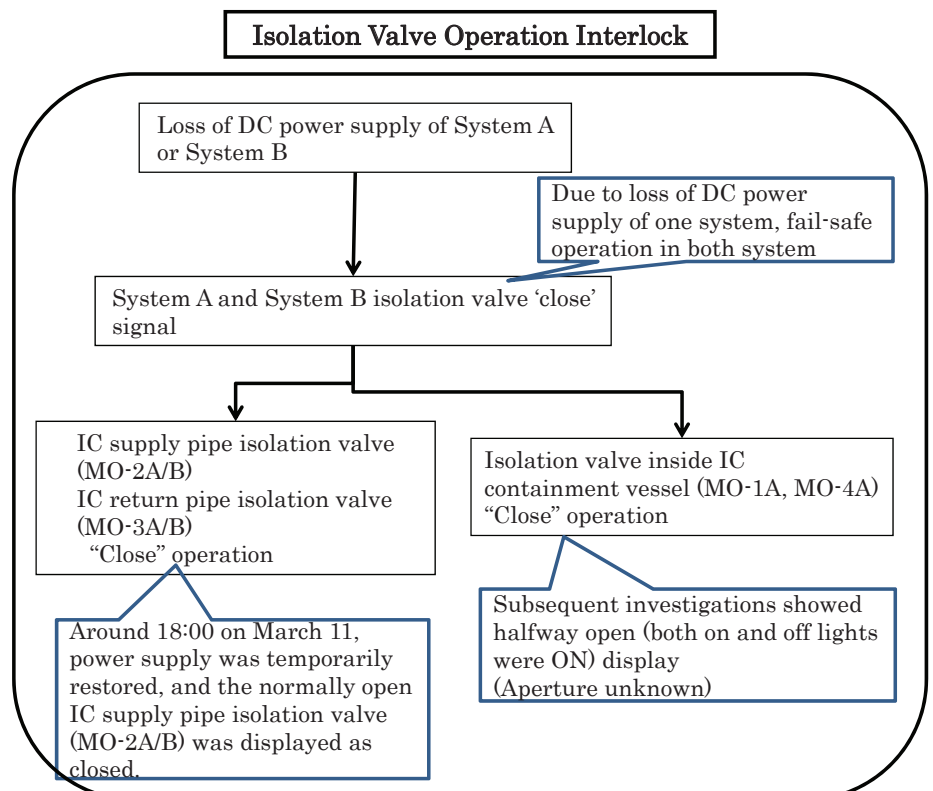

Operating Conditions of the Isolation Condenser (IC) of Unit 1 (cont.)

- Since the valves inside the PCV are operated with AC power, both status-check and operation were impossible even when the DC power supply was temporarily restored.
- The status of the IC was misunderstood.

Systematic and Schematic Diagram of the Isolation Condenser (IC)

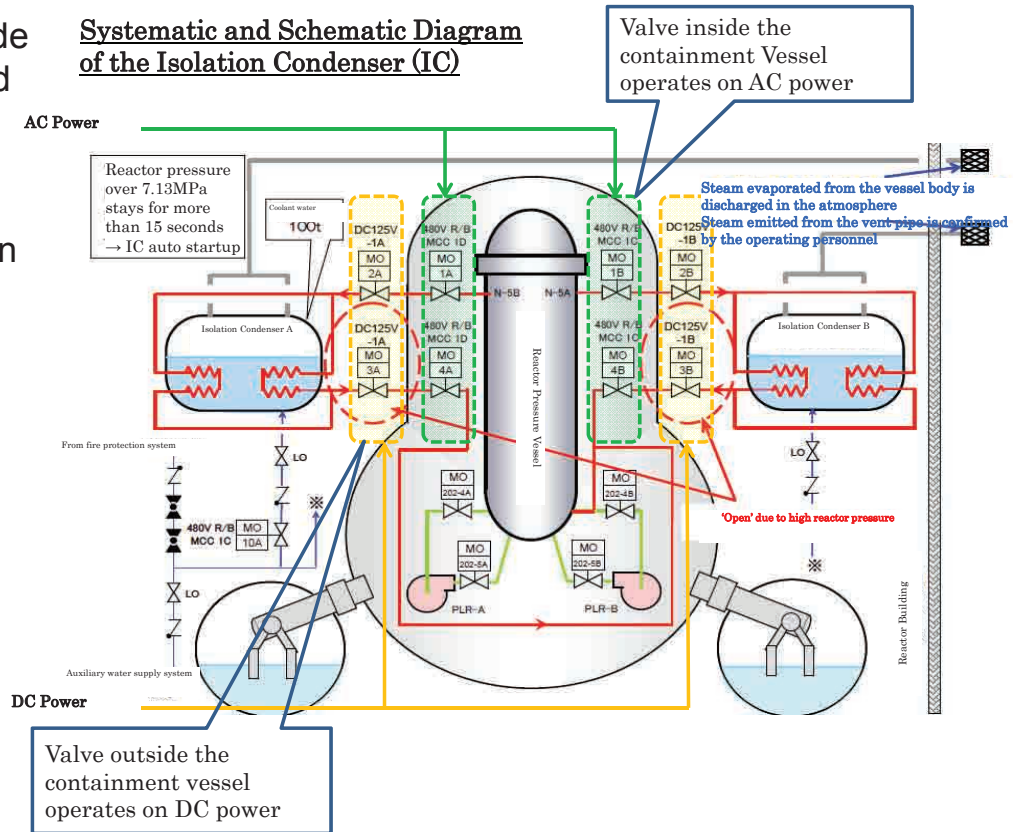

Analysis of Condition of PCV of Unit 2

- In the analysis in June, 2011, PCV leakage was assumed in order to explain slow rise of PCV pressure until Mar. 14.
- It is newly assumed that sea water intruded into the S/C room and contributed to the slow rise of PCV pressure.

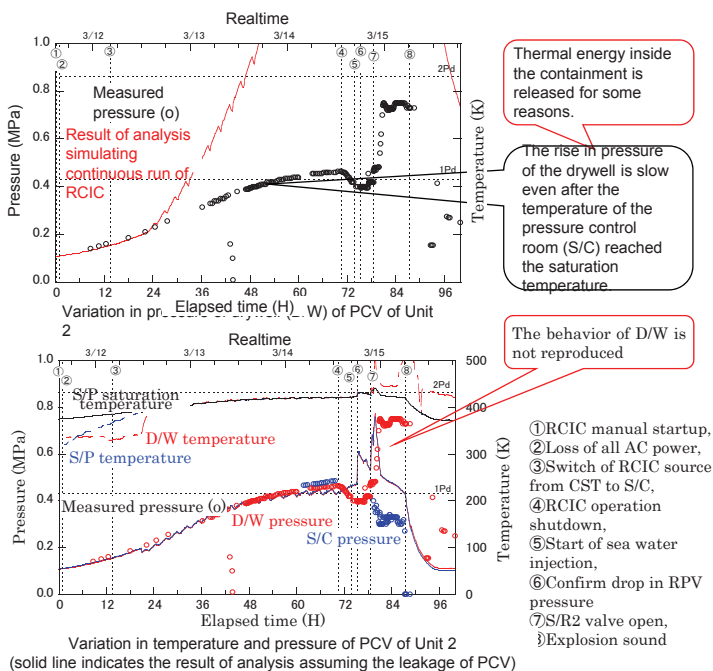

Newly assumed condition

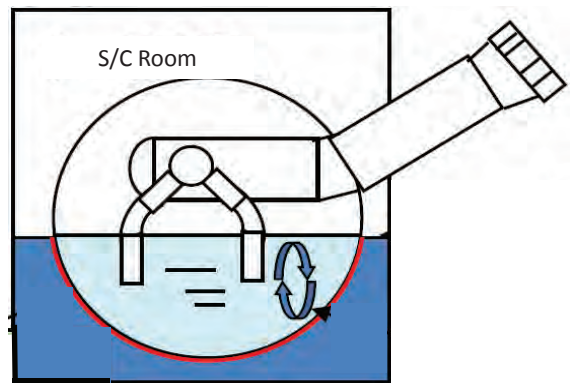

Source: Added to "About evaluation on the situation of the reactor core of Unit 1, Unit 2, and Unit 3 of Tokyo Electric Power Co., Inc. Fukushima Daiichi Nuclear Power Station concerning the accident" (Jun. 6, 2011, revised Oct. 20, 2011, Nuclear and Industrial Safety Agency)

Operating Conditions and Causes of shot down of High Pressure Coolant Injection (HPCI) System of Unit 3

- Situation of HPCI of Unit 3,
 - (1) The amount of flow was adjusted using test lines.
 - (2) Minimum flow line was closed.
 - (3) The HPCI was manually shut down when the reactor pressure dropped below 1MPa.
- This decision on manual shut down was made only by a worker on duty and some other staffs without consulting senior managers.
- Because the SRV could not be opened due to battery depreciation after the HPCI shut down, RPV pressure rose. And alternative low pressure coolant injection by fire truck did not work either.

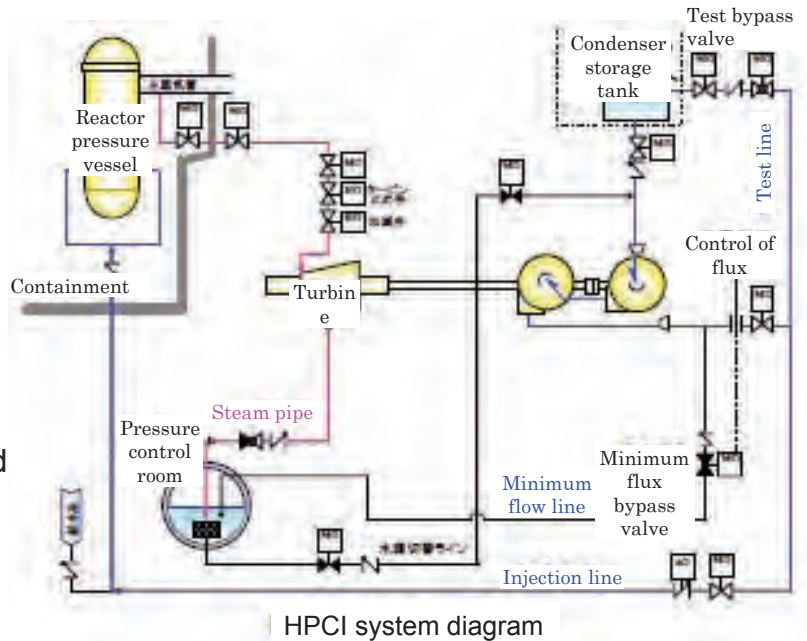

Water level went down, and the core was exposed

Places of Possible Release (Example of Mark-I type Reactor)

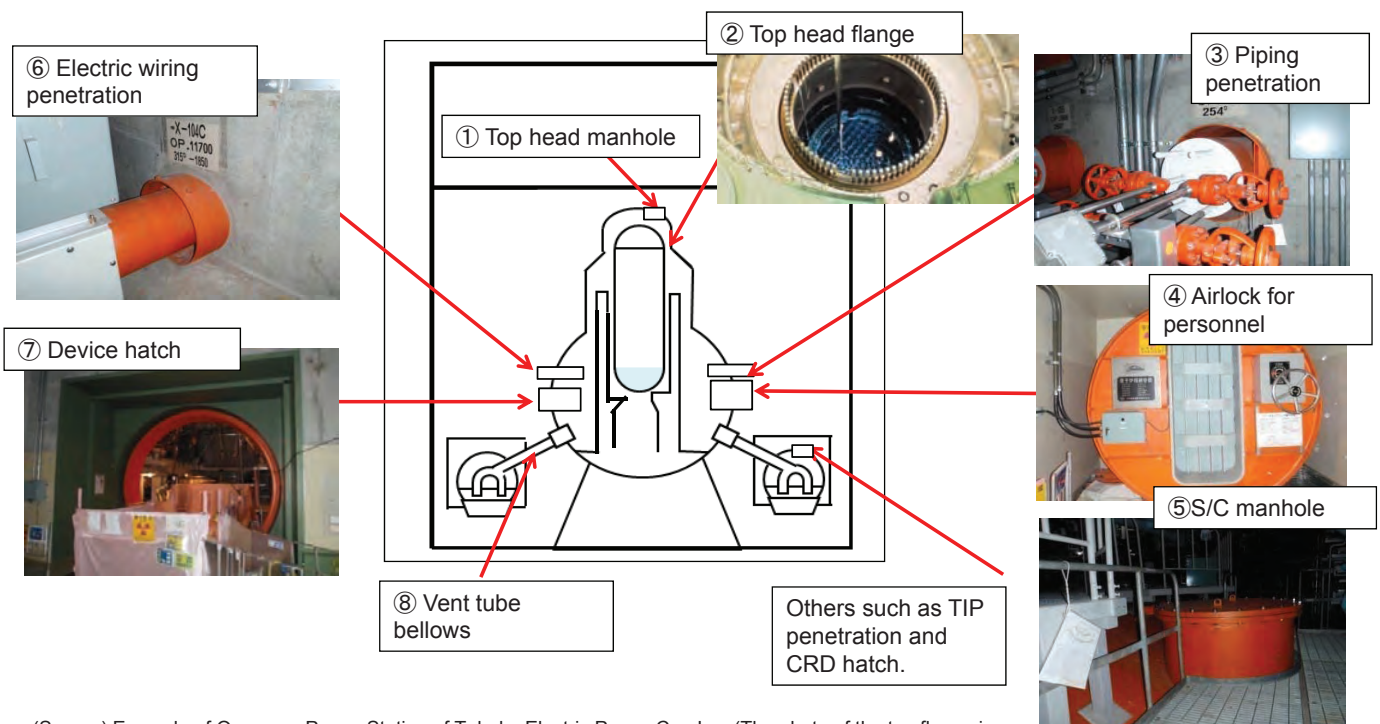

(Source) Example of Onagawa Power Station of Tohoku Electric Power Co., Inc. (The photo of the top flange is courtesy of Tokyo Electric Power Co., Inc.)

Possibility of Containment Damage due to Over-pressurization and/or Over-heating (over-Heating Damage)

- Experiments show leakage can occur from the seal materials of wiring penetration and flange gaskets even under pressure of 0.4~1MPa if heated over 250°C.
- PCVs' temperature were estimated over 500°C for Unit 1, about 280°C for Unit 2, and over 400°C for Unit 3 by MELCOR analysis.
- According to JNES experiments, the leak rate can reach 100%/day at a containment pressure of 0.2MPa, taking only the deterioration of the top flange gasket into account, which is consistent with the situation of large-scale vapor release at the accident.

Example of test results (low-voltage module)

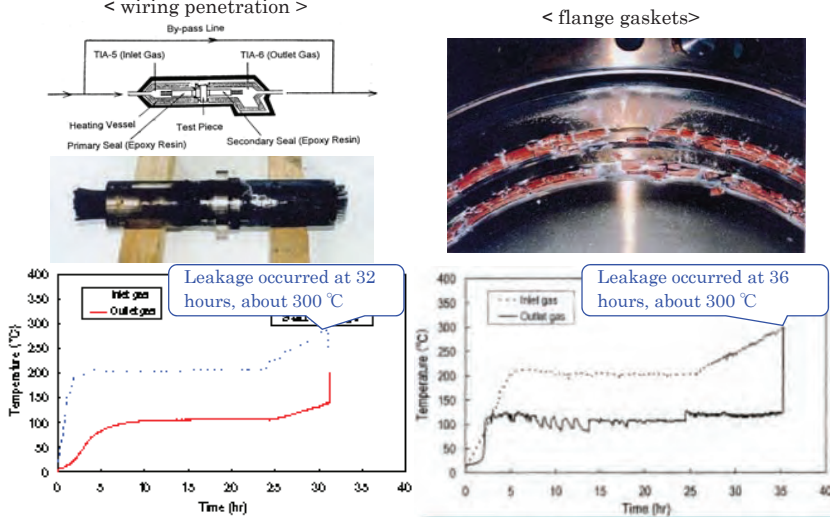

Estimation of leakage rate at the top flange gasket of deterioration due to over-heating

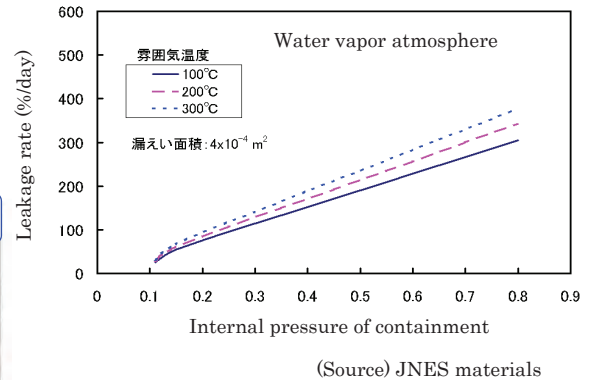

Examination of Leakage Path Using Hydrogen Behavior Analysis (Cont'd)

- For Unit 3, an analysis result of the explosion and the actual damage state show probability of hydrogen leakage through hatches and/or penetrations to 1st floor of the reactor building.

Assuming 1,000kg H₂ leakage from PCV to 1st floor of R/B, an analysis (using AUTODIN) results in damages not only on the upper part of R/B but also other parts including surrounding buildings

The 3rd floor of Unit 3 R/B and the top of a two-story building next to the R/B have also been damaged.

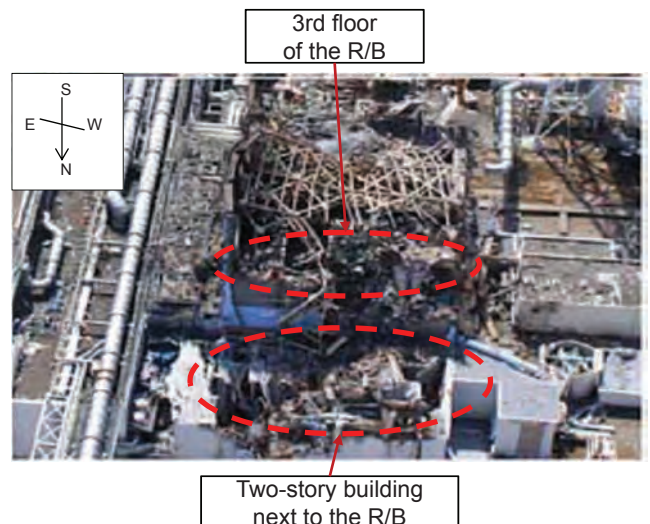
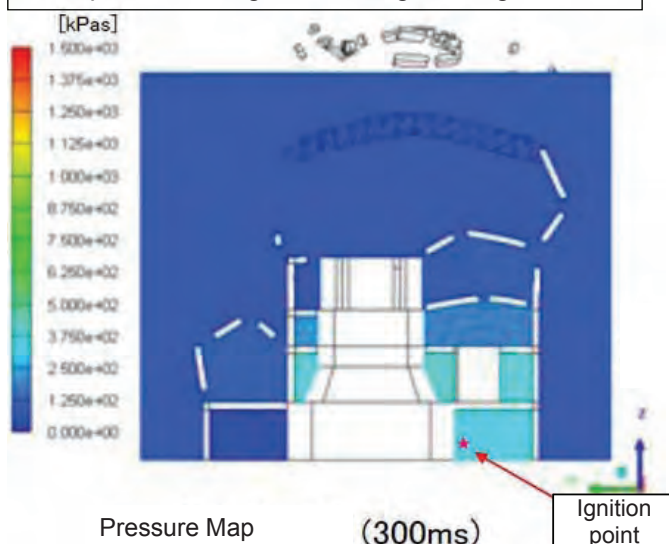

Improve earthquake resistance of substation (on-site)



275kV air blast breaker (ABB)
(Source: Electrical Equipment Earthquake Countermeasures WG)



550kV gas insulated switchgear (GIS)
(Source: Japan AE Power Systems Co. website)

Related Facilities for Countermeasures



Watertight door (Source: The Shikoku Electric Power Co.,Inc.)



Gas turbine generator (Source: The Chugoku Electric Power Co.,Inc.)



Emergency generator of cooling methods through air cooling (Source: The Chugoku Electric Power Co.,Inc.)



125V battery charger room



250V battery charger room



Power supply inlets outside of the buildings
(Source: The Shikoku Electric Power Co.,Inc.)

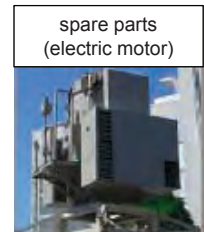

spare parts
(electric motor)

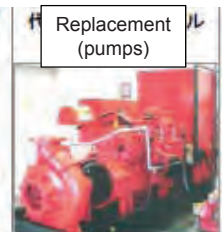

Replacement
(pumps)

Spare parts of electric motors and replacement of pumps (Source: The Chugoku Electric Power Co.,Inc.)

Countermeasures for Cooling Systems (cont.)

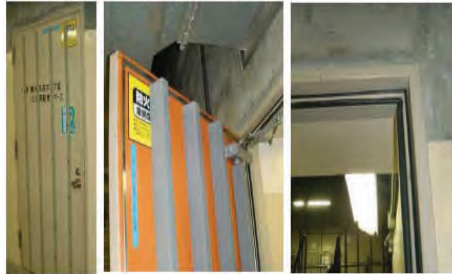

Watertight door (Source: The Chugoku Electric Power Co.,Inc.)

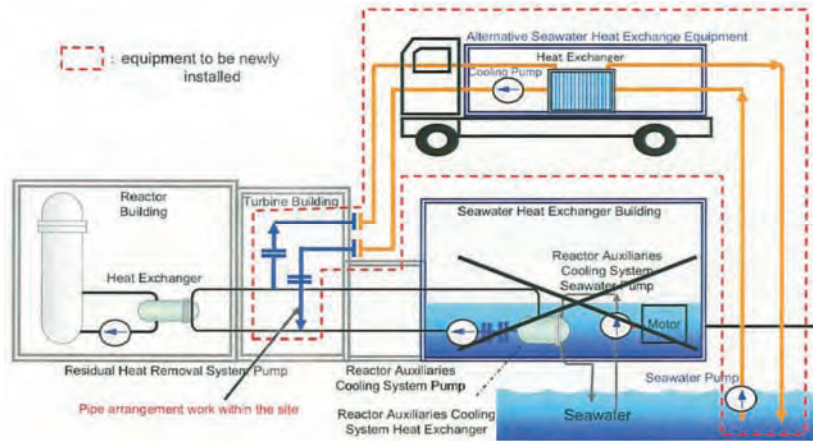

Portable alternative RHRs (Source: TEPCO)

Emergency Response Center in Fukushima Dai-ichi NPS



(Source: TEPCO)

3. Conclusion

- ◆ Japan has been making every effort for of course settling the accident and also thorough investigation of root causes.
- ◆ With Improved regulatory systems and programs, we will continuously seek better ways to achieve even higher level of safety and surely implement them.
- ◆ It is our responsibility to share knowledge and lessons learned through such activities with the international community and to contribute to enhancing global nuclear safety.

Nuclear Safety Action Plan - Key Achievements -

One year after Fukushima: Rethinking the Future

15-16 March, Bologna, Italy

Gustavo Caruso

Special Coordinator for the Implementation of the Action Plan



IAEA

International Atomic Energy Agency

Background

- IAEA Ministerial Conference
 - Ministerial Declaration
 - Working Session Conclusions and recommendations
- Fact-Finding Mission to Japan
- INSAG
- Member States consultations
- Nuclear Safety Action Team

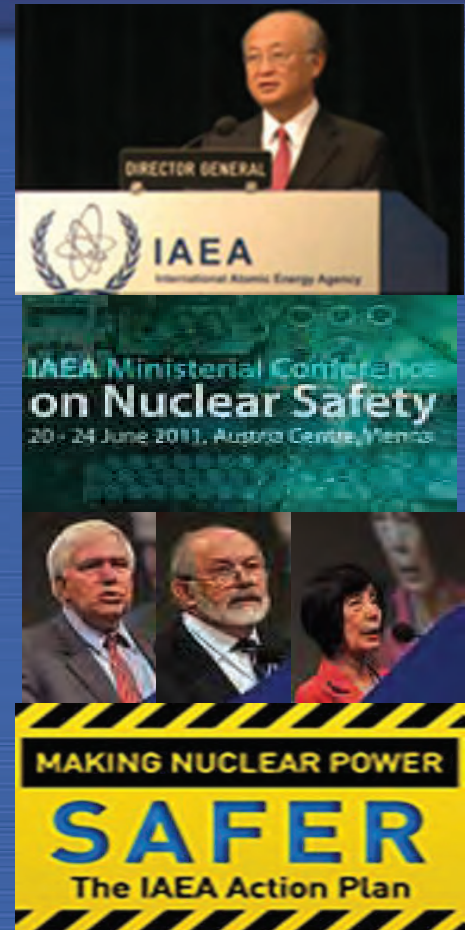

Nuclear Safety Action Team

- Oversee prompt implementation of Action Plan
- Oversight and coordination of activities within IAEA Secretariat and all relevant stakeholders.
- Web Site



<http://www.iaea.org/newscenter/focus/actionplan/>



IAEA Action Plan on Nuclear Safety

- **12 Actions:**
 - Safety Vulnerabilities,
 - Peer Reviews,
 - EPR
 - Regulatory Bodies,
 - Operating Organisations
 - IAEA Safety Standards,
 - Legal Framework
 - Embarking countries,
 - Capacity Building
 - Protection of People + Environment
 - Communication, Research + Development



IAEA

Background

- **Activities identified by the Secretariat to implement the IAEA Action Plan on Nuclear Safety**
- **Cooperation with all Departments and Offices of the IAEA Secretariat**
- **Further activities may be added in future**



IAEA

ASSESSMENT OF SAFETY VULNERABILITIES

- IAEA Methodology to assess safety vulnerabilities of NPPs against site specific extreme natural hazards
- Support and Advice to Member States
- International Expert Mission to Japan
 - January 2012



STRENGTHEN IAEA PEER REVIEWS

- IRRS + EPREV
 - Dedicated 'Fukushima' Modules
- OSART
 - Severe Accident Management
- DRS
 - Assessment of Accident Management
- Increase in Demand for Peer Reviews



STRENGTHEN EMERGENCY PREPAREDNESS AND RESPONSE

- **IAEA Response Assistance Network (RANET)**
 - Meeting on operational arrangements and reporting processes for RANET Teams October 2011
 - Meeting on extension of RANET assistance capabilities February 2012
- **Meeting of Inter-Agency Committee on Radiological and Nuclear Emergencies IARCNE**
 - December 2011



STRENGTHEN THE EFFECTIVENESS OF NATIONAL REGULATORY BODIES

- **Conferences on “Effective Nuclear Regulatory Systems”**
- **IRRS - more systematic and comprehensive assessment of national regulations and guidance based on IAEA Safety Standards**
- **IRRS International workshop**
 - USA October 2011



STRENGTHEN EFFECTIVENESS OF OPERATING ORGANIZATIONS

- Cooperation with World Association of Nuclear Operators (WANO)
 - Coordinate Peer Reviews
 - Safety Standards
 - Embarking Countries
 - New MoU
- IAEA DG Amano
 - WANO Conference October 2011



REVIEW AND STRENGTHEN IAEA SAFETY STANDARDS

- Systematic Review of IAEA Safety Standards
 - Requirements for NPPs
 - Gaps Review
- Streamline Review Process
- Report to IAEA Director General
 - June 2012

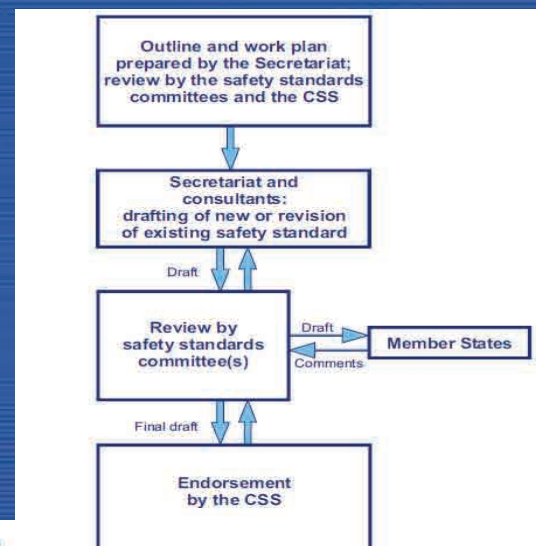
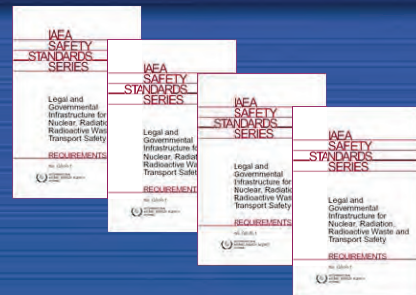

Development Process for the Standards

IMPROVE EFFECTIVENESS OF INTERNATIONAL LEGAL FRAMEWORK

- International Expert Group on Nuclear Liability (INLEX)
- Nuclear Law Institute (NLI)
- Convention on Nuclear Safety
 - Extraordinary Meeting Aug 2012



MEMBER STATES EMBARKING ON NUCLEAR POWER PROGRAMME

- Infrastructure Workshop
 - January 2012
- INIR Mission
 - Embarking Countries
- Safety Infrastructure Guide SSG-16



STRENGTHEN AND MAINTAIN CAPACITY BUILDING

- Guidance on capacity building
- Self-assessment, including
 - Human resources,
 - Education and training,
 - Knowledge management and networks



PROTECTION OF PEOPLE + ENVIRONMENT FROM IONIZING RADIATION

- International Expert Mission on Remediation
Japan October 2011
- Models and Data for Radiological Impact Assessment



Radiation is a fact of life.



COMMUNICATION AND DISSEMINATION OF INFORMATION

- International Experts' Meetings IEMs
 - Reactor and Spent Fuel Safety, **March 2012**
 - Enhancing Transparency and Communication Effectiveness Communication, **June 2012**
 - Remediation and Decommissioning, **March 2013**
- Workshop on Seismic and Tsunami Hazards, **August 2012**
- Ministerial Conference on Nuclear Safety
 - Fukushima Prefecture, **December 2012**
- Effective Regulatory Systems Conference
 - Canada, **April 2013**

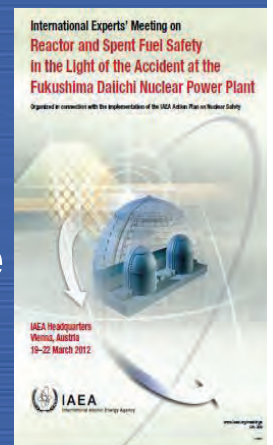

RESEARCH AND DEVELOPMENT

- Technical and Scientific Support Organization (TSO) Forum
- Strengthen scientific and technical coordination and collaboration among Member States
- Steering Committee January 2012



OUTLOOK

- **Strengthening communication to facilitate information sharing with IAEA Secretariat and Member States**
- **Ensure broad dissemination of Action Plan outcomes**
- **Reporting to Board of Governors and IAEA General Conference**



Action Plan: Next Steps

- **Report to June 2012 Board of Governors**
- **Progress on the implementation of the Action Plan will be reported to the September 2012 Board of Governors**
- **Next General Conference 2012**
- **Further reporting annually**
- **Other International Experts Meetings in the area of Emergency Preparedness and Response and International Legal Instruments during 2013**



CONCLUSION

- The purpose of the Action Plan is to define a **programme of work** to strengthen the global nuclear safety framework
- The success of this Action Plan in strengthening nuclear safety is dependent on its implementation through:
 - **Full cooperation and participation** of Member States and will require also the involvement of many other stakeholders, and
 - The availability of appropriate **financial resources** (MS voluntary contributions)



The Stress Tests on the European LWR fleet

Andrej Stritar
Chairman of ENSREG

One year after Fukushima: rethinking the future, Bologna, 16th March 2012

Nuclear Safety Arrangements in EU

- National responsibility
- Nuclear Regulator in every nuclear EU country
- National legislations are in line with international standards
- Since 2009 EU Directive is setting basic principles

EU First Response after 11 March

- Shock, worries, fear ...
- Two days later the term **stress tests of NPPs** was invented by politicians
- By stress tests it should be quickly determined which NPPs are OK
- In the beginning there was no idea how such stress test should look like
 - “Experts will prepare them until June...”

My observation

- Politicians and public were not aware of our means for ensuring nuclear safety:
 - Design Basis Accidents, Initiating Events, Severe Accident Management Guidelines, Emergency Preparedness etc.
 - Nothing about Periodic Safety Reviews
 - No mentioning of our conventions
 - No mentioning of peer review missions
 - No mentioning of IAEA standards
- Public could get impression we are totally unprepared to any external event!

- Nuclear community was probably not communicating properly to the wider society about our routine stringent work

or

- We must get from time to time a strong, although painful push to revise and revive our routine activities!

Development of Stress Test Methodology

- Drafted by WENRA in April
- Intensive communication also with other stakeholders
- After intensive two days of discussions ENSREG endorsed it on 12 May
- After further discussions with the Commission the EU Stress Tests methodology was announced on 24 May 2011



Declaration of ENSREG

ENSREG and the European Commission have worked intensively to provide a response to the request of the European Council on 25 March 2011.

Notably, they have developed the scope and modalities for comprehensive risk and safety assessments of EU nuclear power plants. On 13 May 2011, ENSREG and the Commission have agreed the following:

1. In the light of the Fukushima accident, comprehensive risk and safety assessments undertaken by the operators under the supervision of the national regulatory authorities of nuclear power plants will start at the latest by 1 June 2011. These assessments will be based on the specifications in annex 1 largely prepared by WENRA and will cover extraordinary triggering events like earthquakes and flooding, and the consequences of any other initiating events potentially leading to multiple loss of safety functions requiring severe accident management. The methodology of these assessments is covered by annex 1. Human and organisational factors should be part of these assessments;

2. Risks due to security threats are not part of the mandate of ENSREG and the prevention and response to incidents due to malevolent or terrorists acts (including aircraft crashes) involve different competent authorities, hence it is proposed that the Council establishes a specific working group composed of Member States and associating the European Commission, within their respective competences, to deal with that issues. The mandate and modalities of work of this group would be defined through Council Conclusions¹.

3. Paragraphs 1 and 2 above contribute to a comprehensive risk and safety assessment.



Annex I

EU “Stress tests” specifications

Introduction

Considering the accident at the Fukushima nuclear power plant in Japan, the European Council of March 24th and 25th declared that “the safety of all EU nuclear plants should be reviewed, on the basis of a comprehensive and transparent risk assessment (“stress tests”); the European Nuclear Safety Regulatory Group (ENSREG) and the Commission are invited to develop as soon as possible the scope and modalities of these tests in a coordinated framework in the light of the lessons learned from the accident in Japan and with the full involvement of Member States, making full use of available expertise (notably from the Western European Nuclear Regulators Association); the assessments will be conducted by independent national authorities and through peer review; their outcome and any necessary subsequent measures that will be taken should be shared with the Commission and within ENSREG and should be made public; the European Council will assess initial findings by the end of 2011, on the basis of a report from the Commission”.

On the basis of the proposals made by WENRA at their plenary meeting on the 12-13 of May, the European Commission and ENSREG members decided to agree upon “an initial independent regulatory technical definition of a “stress test” and how it should be applied to nuclear facilities across Europe”. This is the purpose of this document.



Stress Tests Highlights

- Operators had to review:
 - Earthquakes and flooding
 - Issues of loss of power, ultimate heat sink or combination of both as a consequence of any event
 - Severe accident management issues
- Terrorist issues to be analysed separately
 - Special Ad-hoc group at EU level was formed
- National Regulators have prepared national summary reports
- Peer Reviews are currently underway

Stress Tests Schedule

- 1 June 2011: Start
- 15 August: Operator's progress reports
- 15 September: National progress reports
- 31 October: Final Operator's reports
- November: EU Summary progress report
- 9 December: EU Council meeting
- 31 December: Final National reports
- 25 April: Final Peer Review Report
- June 2012: Final EU report to EU Council

Peer Reviews

- Three Peer Review Teams, ~25 members each
- Three topics:
 - Earthquakes and flooding
 - Loss of power, ultimate heat sink or combination of both as a consequence of any event
 - Severe accident management
- Two weeks of work in February
- Country Report reviews in parallel
- Country visits in March
- Final Report to be endorsed by ENSREG on 25 April

What are we getting from Stress Tests?

- Thorough review of preparedness against severe accidents
- Quick improvements: additional pumps, power sources, fire protection equipment, guidelines ...
- Directions for major improvements: additional safety trains, containment venting, heat sinks ...

Change in the philosophy

Before

Safety margins are (too) big, let us improve efficiency by reducing them

Now

Don't reduce safety margins, increase them!

Stress Tests – Slovenian example



Operator's first response

- Already in March started looking for improvements
- Followed INPO and WANO recommendations (SAME)
- By end of May applied to the regulator for small modifications to facilitate connection of external equipment
- By June purchased new pumps, diesel generators, compressors, fire fighting equipment, SAMGs were improved ...





Regulator's first actions

- From 15 March preparing EU Stress Tests
- By end of May the performance of EU Stress Tests was requested by a formal decision
- In summer additional requirements were prepared, formally requested in September

Additional requirements:

- Review Severe Accident preparedness
- Prepare action plan related to:
 - Power supply
 - Core cooling
 - Containment integrity
 - Potential controlled release of radioactivity
 - Additional control room
 - Spent fuel management
- Submit action plan by 15 January 2012
- Implement action plan by 2016

Action plan by 2016

- Additional seismic qualification of DG 3 local switchyard
- Containment venting, hydrogen control
- Additional control room
- Additional safety injection train
- Alternative spent fuel pool cooling
- Additional ultimate heat sink
- Alternative waste and spent fuel strategy

On going projects

Actions after first PSR in 2003:

- Third safety grade Diesel Generator will be installed this May
 - Significantly decreases CDF
- Flood protection dykes along the river are increased for 1.5 m
 - Improved protection against theoretically worst flood
- The air plane impact actions according to US NRC B5b

Regulator's third request

- In January 2012 another formal request to re-analyse off-site emergency response and propose improvements
- Due by the end of 2012

In summary in Slovenia

- Stress Tests performed
 - Most significant cliff-edge effect is earthquake above ~0.9 g – very unlikely
- New equipment on site
- New SAMG procedures
- Action plan for major improvements

Impact of Stress Tests on European Legislation

To have or not to have Common Legislation ...

- Nuclear sector is not immune to one of the basic questions of EU:
 - How much sovereignty are Member States willing to give to Brussels?or in other words:
 - Are we loose association of independent states or to some extent centralised Federation?

Two extreme situations

EC desires

- EU Legislation and standards
- Centralised regulation including enforcement

Country desires

- National Legislation based on international standards
- National regulators and enforcement

As always, the compromise between extremes is the solution

Harmonising national practices

- WENRA, a club of National Regulators
- Reference Levels – agreed standards, which we all implement in our countries
- Intensive communication. Harmonisation of practices



This I call **bottom-up** approach

Softening centralised desires

- Council and Commission have established ENSREG – formal group of top regulators
- ENSREG advises about EC legal initiatives
- Two directives have already been adopted

This I call **top-down** approach



Top-down, legally binding

We are always afraid of legally binding things!
“What if we make mistake and get punished?”



There will always be reluctance towards legally binding rules!

National Nuclear Legal Framework

Healthy motivation is needed for voluntary actions.



If motivated, voluntarily we can move mountains ...

Bottom-up, voluntarily

Impact of Fukushima

- **Bottom-up:**
- Stress Tests are common voluntary exercise aiming at further harmonisation and permanent improvements

Impact of Fukushima

- Ideas for strengthening **top-down** approach:
 - Commission has launched public enquiry
 - ENSREG is collecting ideas
 - Ideas to improve the Nuclear Safety Convention
 - IAEA has its Action Plan

Where to go with nuclear safety arrangements in EU

- EU could have legally binding more than just basic principles
- EU harmonised system of licensing nuclear facilities and activities
- Competent National Regulators with power and responsibilities
- Harmonised Emergency Arrangements
- Harmonised Anti-terrorist Arrangements
- Harmonised TSO support
- Harmonised Research

**Workshop on “One year after Fukushima: rethinking the future”
Italian National School for Public Administration
Via Testoni n. 2 – Bologna Italy
15-16 March 2012**

IRSN

INSTITUT
DE RADIOPROTECTION
ET DE SÛRETÉ NUCLÉAIRE

Faire avancer la sûreté nucléaire

**Emergency Preparedness
and On-site and Off-site Response Systems
*IRSN’s Response to the Fukushima Events***



O. Isnard & G.B. Bruna, IRSN

- The fundamental principle in nuclear safety is the prime responsibility of the plant Operator,
- In case of emergency, the Operator has to undertake the actions which can recover the plant in case of miss-operation and incident and/or mitigate the consequences of the accidents.
- To do that, the Operator is to rely on its own *Technical Emergency Centre*, which:
 - - Operates under the control of The Safety Authority,
 - - Communicates with the national network of *Emergency Centres*,
 - - Relies on the Constructor's advice for undertaking the recovery actions,
 - - Provides the Authorities, the stakeholders and the general public with up-dated information.

- The Safety Authority generally relies on the Technical Safety Organisation(s) - TSOs - (in, France, the IRSN - *Institut de Radioprotection et Sûreté Nucléaire* - Institute for Radio-protection and Nuclear Safety) for *assessment*, expertise, advice and technical support.
- In emergency conditions, the main goal of a TSO is
 - The prediction,
 - The preliminary rough quantification,
 - The continuous improvement and up-dating of the potential risk for releases of contaminants to the environment,
 - The information of the stakeholders and the general public,
 - The contribution to the elaboration and settling of an intervention scenario for the plant workers, if necessary.

To achieve these objectives it is worth 1/2:

- Mastering the NPP component and system design and operation and their weaknesses and main failure modes,
- Investigating the origin of the event generating the risk,
- Understanding the physical phenomena generating the risk and identifying its potential for evolution and propagation to other installation on the site,

To achieve these objectives it is worth 2/2:

- Evaluating the source-term scenario relying on the predicted and up-dated information on the site features and the meteorological conditions,
- Monitoring the radioactivity spreading-off,
- Dispatching emergency mobile means for monitoring,
- Providing the Authorities with expertise,
- Communicating to the press and the public.

As a TSO, member of the European ETSON - European Technical Safety Organisation Network, **the main objectives of IRSN are:**

- Providing technical expertise to the French Nuclear Regulatory Authority,
- Communicating to the public and private stakeholders and to the general public,
- Performing R&D activities, either on its own or as an active member of international groups and initiatives, as well.

To achieve these withstanding goals, IRSN relies on several hundreds skilled experts in different fields of endeavour, ranging from the nuclear safety to the radioprotection of the environment and the man.

The IRSN's *Technical Emergency Centre* within the organization for emergency preparedness, relies upon:

- A wide network of information and expertise gathering all the characters in the field,
- The knowledge from periodical crisis exercises,
- The capitalization of knowledge through operating experience,
- The first-hand evaluations made with the computation and prediction tools available in the Centre premises,
- The monitoring network of in-situ and mobile devices,
- The outcomes of studies and R&D programs, carried-out within in national and international frameworks,
- The back-up support from off-site expert teams to complete and refine these rough evaluations,
- The application of the rules,
- The awareness of the socio-economical context (public acceptance, media coverage ...).

- IRSN is a public technical body
- it provides technical expertise to public Authorities
- It communicates to the public

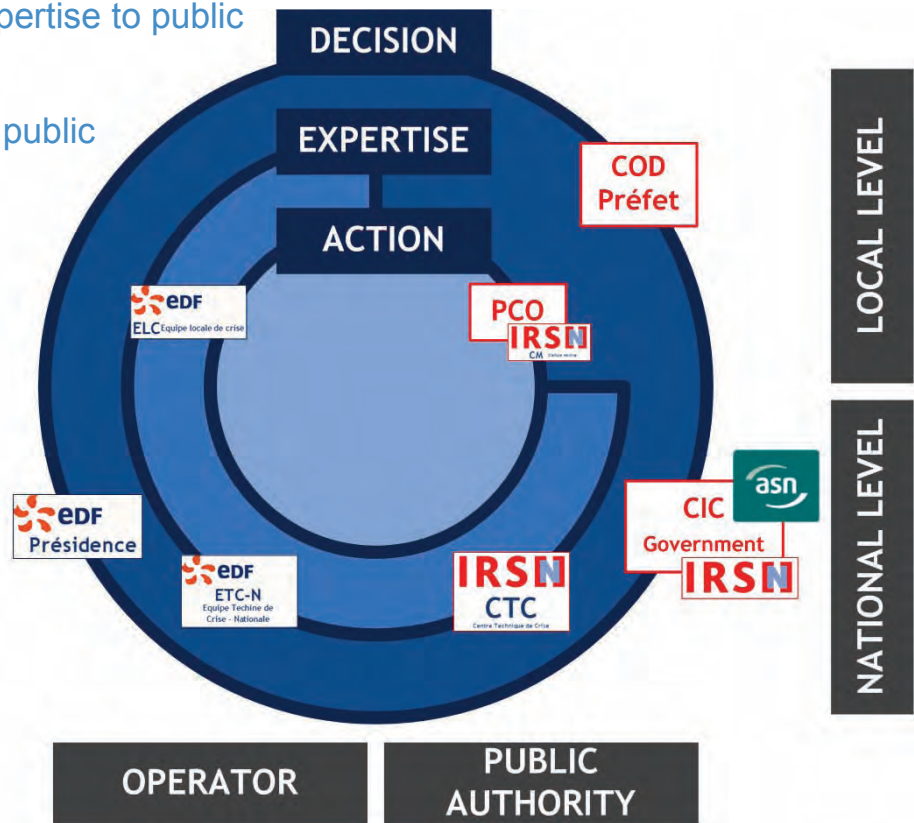

IRSN - Organisation and means

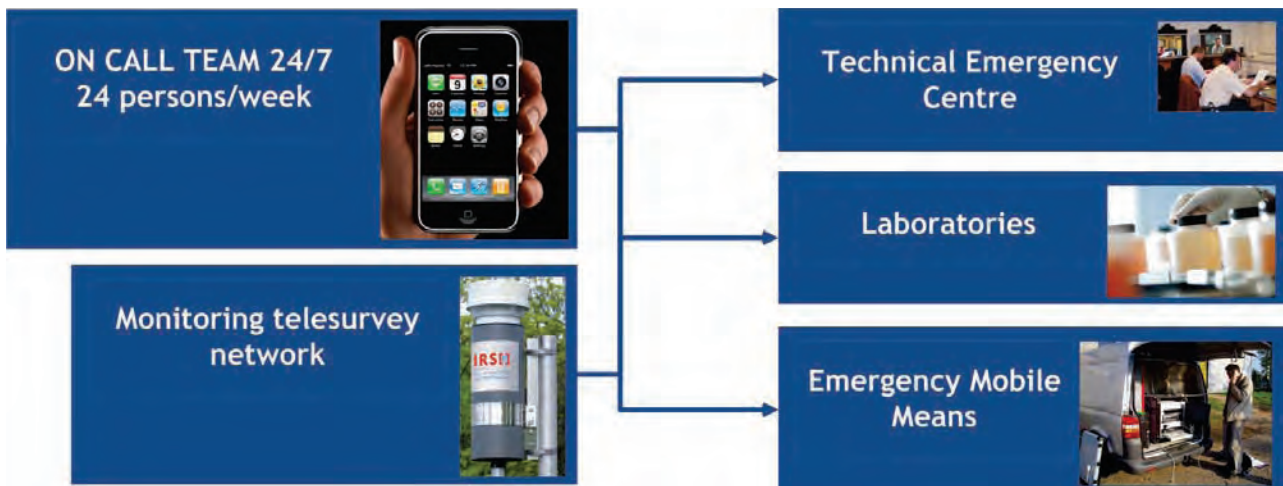

- Trained experts: 400 in 20 different fields of endeavour
- Emergency preparedness :
 - 2000 training hours/year
 - 12 to 15 national exercises/year
- Logistic:
 - Operational maintenance : 5 full time persons
 - Development of organisations, methods & tools : 25 full time persons
 - Budget: 3 M€/year

Emergency Mobile Means



- ▶ 1 command car (liaison with CTC)
- ▶ 4 T5 car (light truck for intervention)
- ▶ 3 lab trucks for environment (1200 meas./d)
- ▶ 4 lab trucks for humans (960 p/d)
- ▶ 2 heavy trucks for humans (80 p/d)
- ▶ 2 shelters for humans (2100 p/d)
- ▶ 1 T5 car for transportation crisis



- ▶ 4 T5 car (light truck for intervention)
- ▶ 1 T5 car for transportation crisis



- ▶ 3 lab trucks for environment (1200 meas./d)
- ▶ 4 lab trucks for humans (960 p/d)



2 heavy trucks for humans (80 p/d)



2 shelters for humans (2100 p/d)

Monitoring telesurvey network



Actually 164 gamma Stations (450)



Teleray

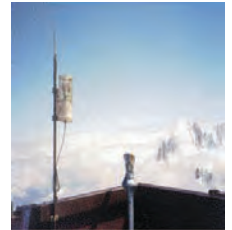

Hydro-Teleray



Aerosols



Technical Emergency Centre



- ▶ Activation within 1 hour
- ▶ Completion of the initial team (10 to 25 p.)
- ▶ First advice delivered within 1 hour
- ▶ 200 m² dedicated to crisis management
- ▶ 25 m³ of specific documentation
- ▶ A dozen of specific softwares



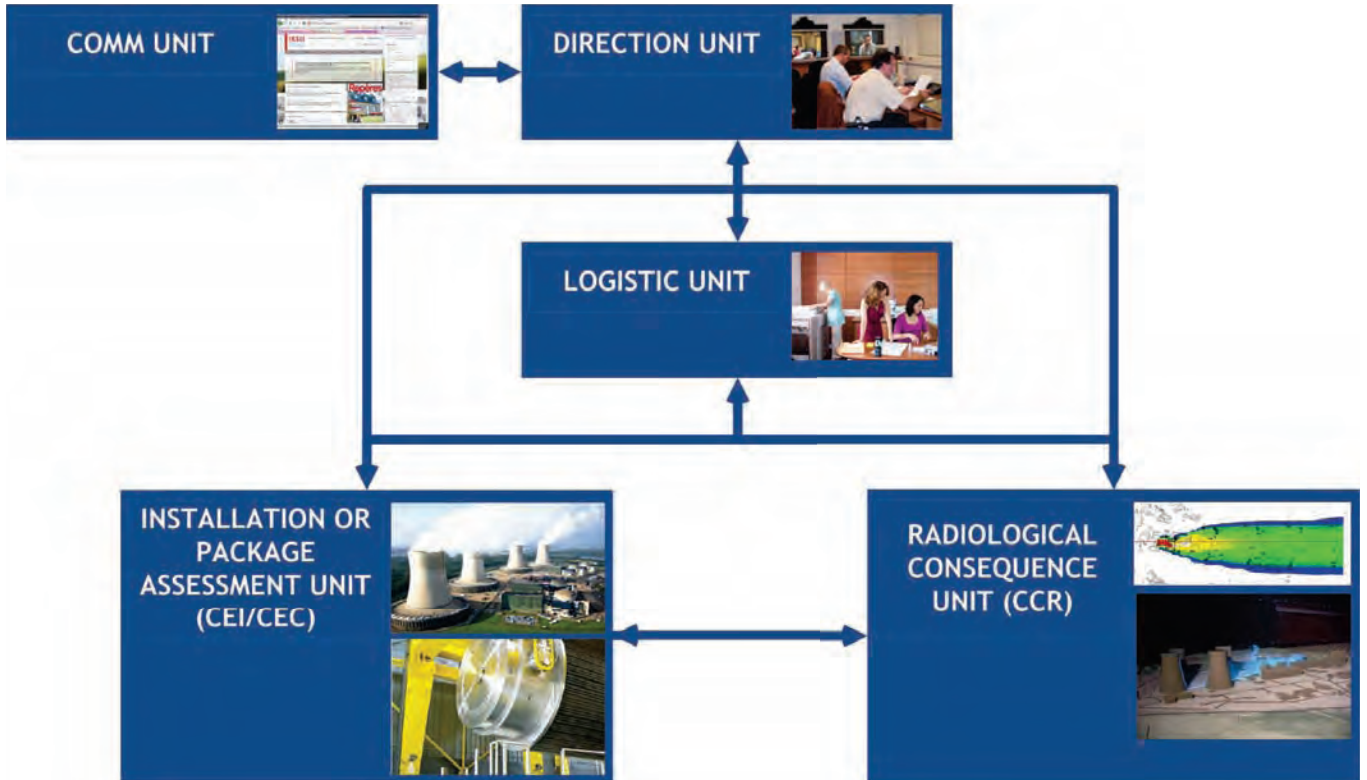

Typical work-force: 25 persons

IRSN's national interfaces

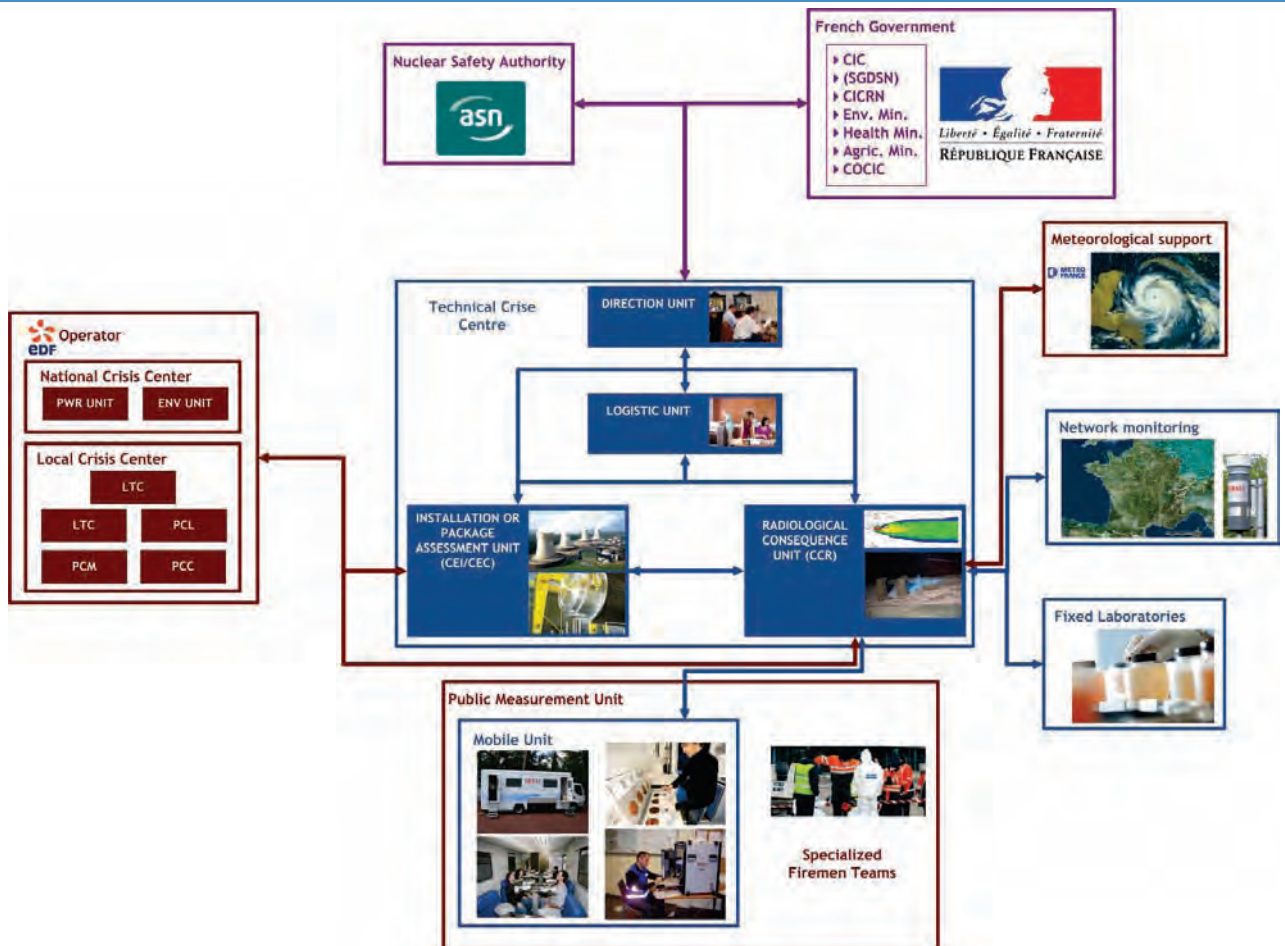

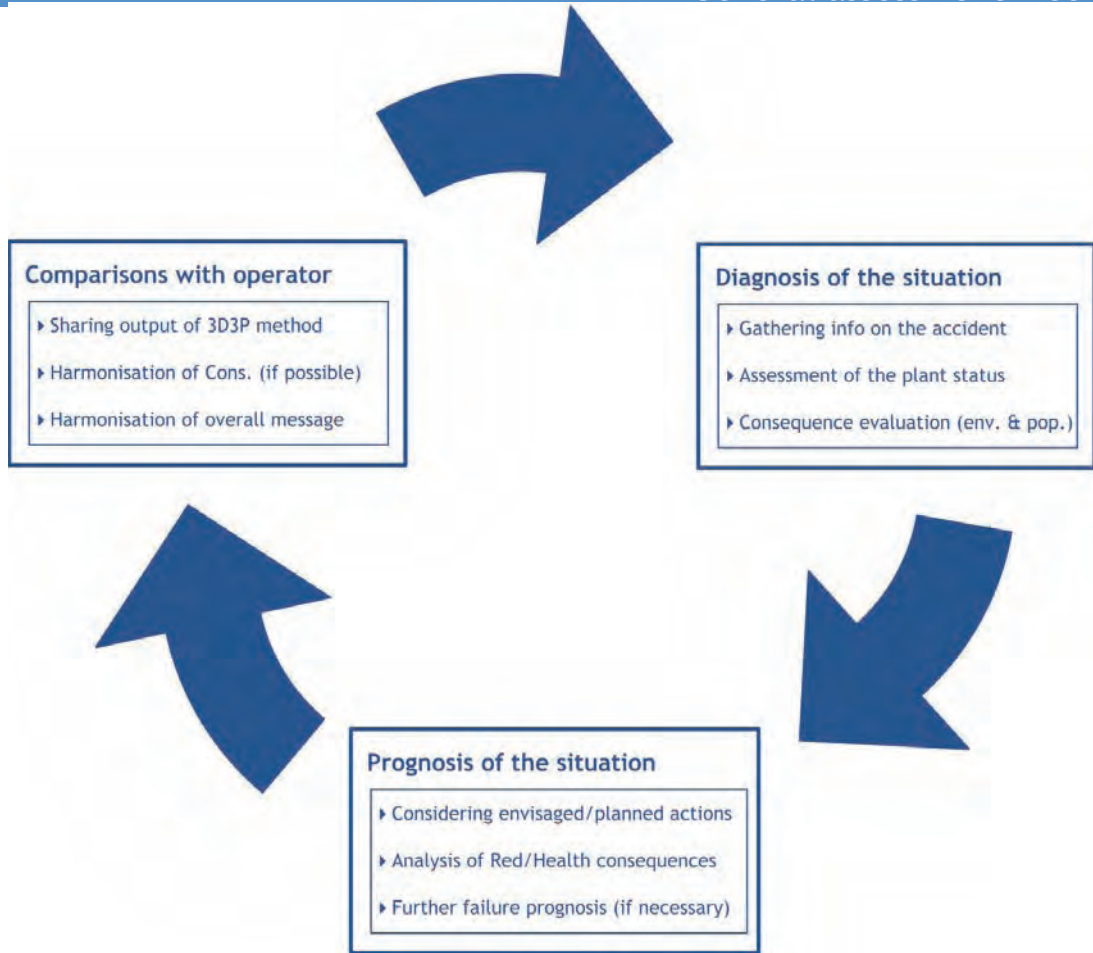

Information acquisition means

- AUDIOCONFERENCES
- INSTALLATION/ENVIRONMENT
- FRENCH PWR: AUTOMATIC ON-LINE CONNECTION
- 100 PARAMETERS/MINUTES
- FRENCH MET OFFICE (Météo France)
- Met forecasts & observations

- RECEPTION BY FAX OF PRE-FORMATED MESSAGES
- PERIODIC MESSAGES
- TELESURVEY NETWORK
- 180 TELERAY, 10 TELEHYDRO
- Mobile measurements
- Local env. measures



- Activation of the Technical Crisis Centre lasting for 6 weeks
- Modification of IRSN internal organisation
 - “Health” Unit for any health issues
 - “Environment” Unit for monitoring in France
- Local response: Dispatching technical adviser to the French Embassy in Tokyo

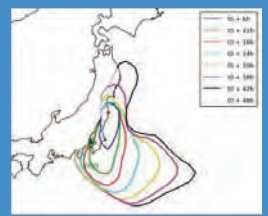

Activation of the Technical Crisis Centre

- Activation on March 11 @ 10 UTC, De-activation on April 29 @ 10 UTC
- 24/7 mode operation during 4 weeks
 - 30+ experts during day time (inc. spokesmen)
 - 20+ experts during night time
 - Organisation with a “action/anticipation” team @ CTC, and an “investigation” team in back office

Role

- Evaluation of the reactors state, releases to the atmosphere (diagnostic/prognosis)
- Evaluation of the radiological consequences (doses et depositions)
- Analysis of the measures over the world, assimilation

During the Fukushima crisis, IRSN had to face a high media pressure in France. It answered to more than 1000 questions from journalists. Providing technical information to the media (and French people in Japan) became a major objective and challenge.



Response to any health issues

- Public services
- People of the public
- Industrials
- Journalists
- Med / Pharma

1500 treated demands

- 7 phone lines 24/7
- 144 measures anthropo
 - Thyroid Dose : 0.01 à 1.3 mSv
 - Effective Dose : 0.001 à 0.03 mSv

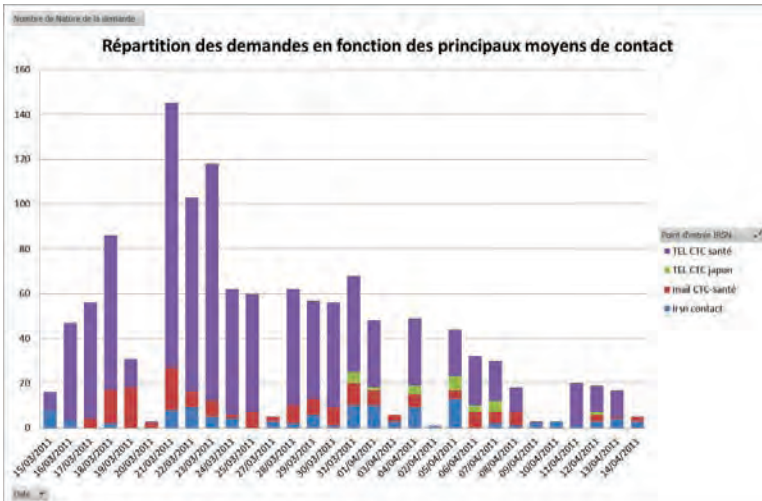

Technical adviser in Japan

Technical advice to the French Embassy

- Recommendations pour French people living in Japan
- Daily briefing at the Embassy
- Consulting for French Industrials
- Receiving journalists (consulting, interviews)
- Installation of stations & local measurements

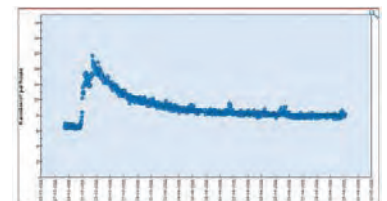

Support to the French rescue team (130)

- Objective doses, limits
- Daily risk analysis
- Radioprotection during a travel to S

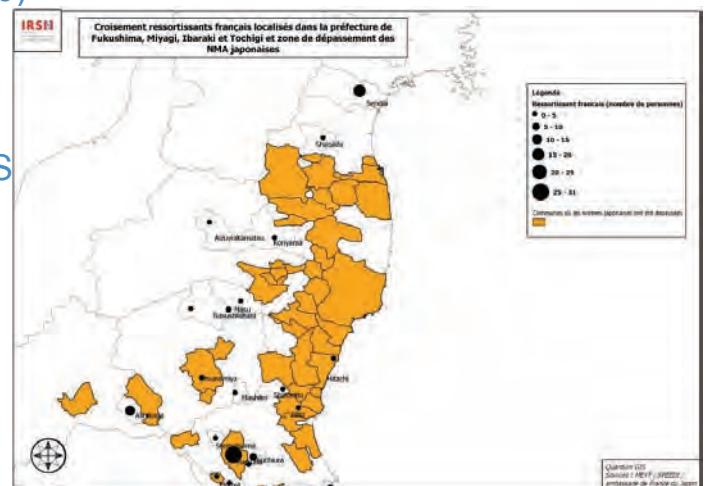

Conclusions

- | During the Fukushima's event, the IRSN's *CTC* was maintained in continuous operation and provided, on a daily basis, with analysis and prognosis on the reactors status and the radiological consequences of the crisis.
- | That provided the *CTC* with a unique opportunity to check its preparedness to face crisis situations.
- | Importance of
 - Preparedness
 - Availability of information
 - Reliability of information
 - Engineering feeling
 - Team work
- | Need for reliable, quick-running computation tools.

15-16 March 2012 - Bologna, Italy

Consequences and follow-up of the Fukushima accident on EU and non-EU countries

Giuseppe Zollino
AIN Scientific Council and University of Padova

Chiara Bustreo, Guido Meneghini, Antonio Bellinaso
University of Padova



One year after Fukushima: rethinking the future

	Before Fukushima		After Fukushima	
ARGENTINA	2	935		
ARMENIA	1	375		
BELGIUM	7	5927		
BRAZIL	2	1884		
BULGARIA	2	1906		
CANADA	18	12604		
CHINA	11	8438	16	11816
CZECH REPUBLIC	6	3766		
FINLAND	4	2736		
FRANCE	58	63130		
GERMANY	17	20470	9	12068
HUNGARY	4	1889		
INDIA	18	3984	20	4391
IRAN	-	-	1	915
JAPAN	54	46823	50	44215
SOUTH KOREA	20	17647	23	20671
MEXICO	2	1300		
NETHERLANDS	1	482		
PAKISTAN	2	425	3	725
ROMANIA	2	1300		
RUSSIA	31	21743	33	23643
SLOVAKIA	4	1816		
SLOVENIA	1	688		
SOUTH AFRICA	2	1830		
SPAIN	8	7567		
SWEDEN	10	9326		
SWITZERLAND	5	3263		
UKRAINE	15	13107		
UK	19	10097	17	9703
USA				
TOTAL	436	370300	436	369000

2

PRIS

ific Council

Worldwide reactors under construction

March 2012

3

Source: IAEA-PRIS

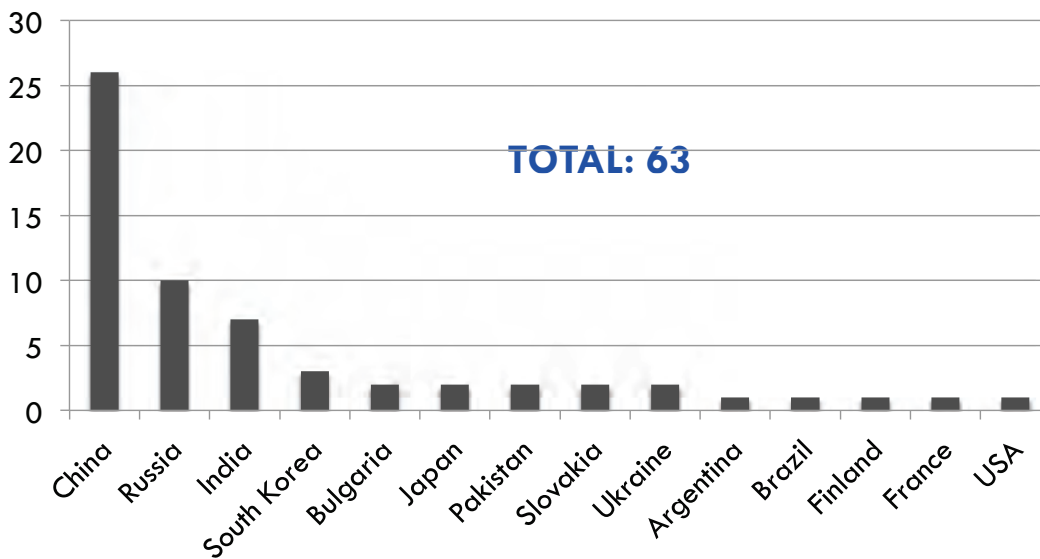

Worldwide planned reactors (new nuclear countries in red)

4

Source: WNA

Argentina	2	Japan	10	Czech Rep.	2
Armenia	1	Jordan	1	Romania	2
Bangladesh	2	Great Britain	4	Russia	17
Belarus	2	India	16	Turkey	4
Canada	3	Indonesia	2	Ukraine	2
China	51	Iran	2	USA	11
South Korea	6	Kazakhstan	2	Vietnam	4
Egypt	1	Lithuania	1	TOTAL	162
U. A. Emirates	4	Pakistan	1		
France	1	Poland	6		



One year after Fukushima: rethinking the future

G.Zollino et al, AIN Scientific Council

Other NO-nuclear countries where new reactors are proposed

5

Source: WNA

Saudi Arabia	16	North Korea	1
Chile	4	Malaysia	2
Israel	1	Thailand	5



One year after Fukushima: rethinking the future

G.Zollino et al, AIN Scientific Council

Countries where nuclear programs are currently suspended

6

- **ITALY**
D.L. n°34 31/3/2011 and referendum in June 2011
- **GERMANY**
phase-out by 2022
- **SWITZERLAND**
new constructions only for new generation reactors
- **BELGIUM**
planned phase-out in 2003, only with equivalent alternatives
-



One year after Fukushima: rethinking the future

G.Zollino et al, AIN Scientific Council

After moratorium, **Germany** started to import electric power:

7

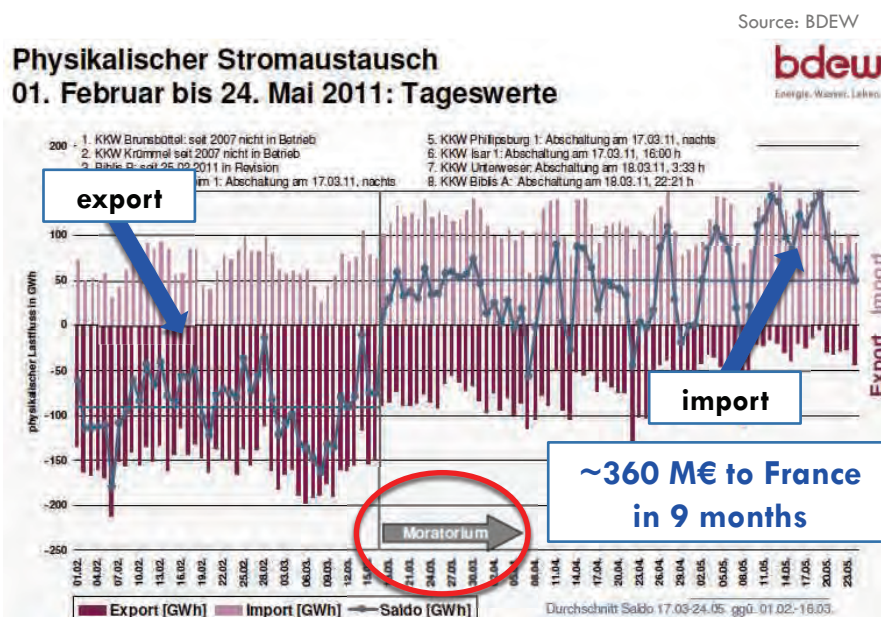

One year after Fukushima: rethinking the future

G.Zollino et al, AIN Scientific Council

German coal power generation January-May, 2007-2011

8

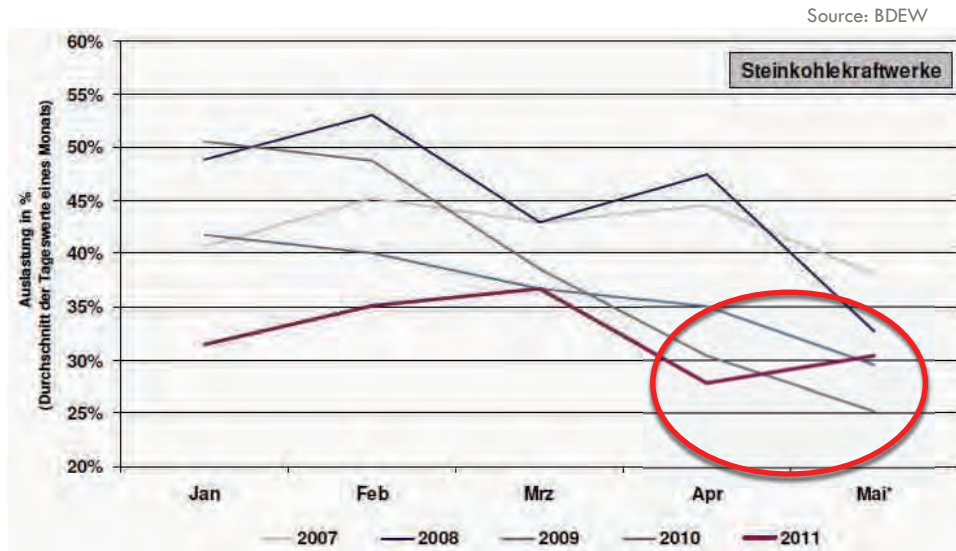

From April to March (after the moratorium) **German coal electric power increased**, contrary to previous years.



One year after Fukushima: rethinking the future

G.Zollino et al, AIN Scientific Council

Electric productions and import/export flow from November 2010 to November 2011

9

Source: IEA

	Fossils	Nuclear	Import	Export
Japan	+29,9%	-71%	0%	0%
Germany	+7,6%	-30,9%	+32%	+2,9%
France	+1%	-4,9%	-26,9%	+27,1%

In addition, **Czech Republic exported:**

November 2010 : 1,11 TWh, 19,8% of its electric demand.

November 2011: 1,55 TWh, 26,6% of its demand.



One year after Fukushima: rethinking the future

G.Zollino et al, AIN Scientific Council

A measure of the discontinuity of renewable power in Germany.

10

Source: BDEW

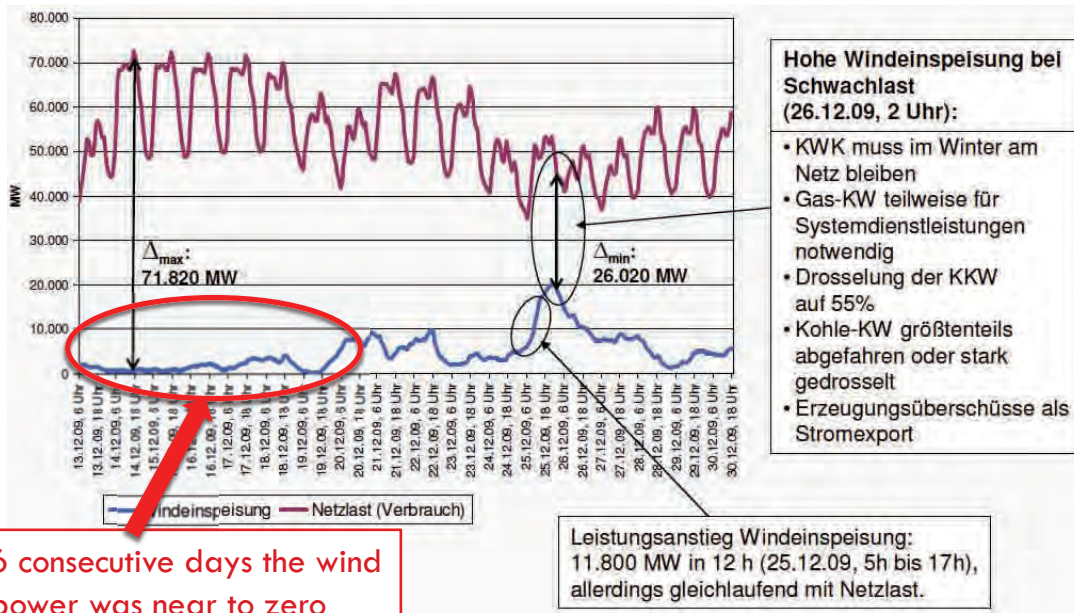

One year after Fukushima: rethinking the future

G.Zollino et al, AIN Scientific Council

German electricity price before and after the nuclear moratorium

11

Source: BDEW

Großhandelsmarkt: Strompreise an der EEX
Terminmarkt, Baseload

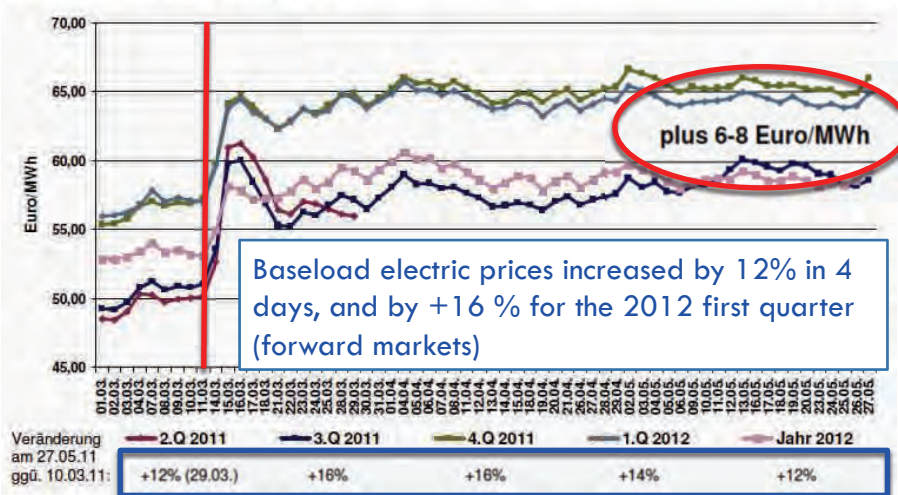

In 2018, German electricity price is expected to increase by 30%

G.Zollino et al, AIN Scientific Council

Is it really over?



Long term Energy roadmaps (IEA, EU, various think thank..)
GOAL: huge CO₂ cuts by 2050 towards 450 ppm CO₂ in 2010

For Example,

On 15th December 2011 the EC published its "*EU Energy Roadmap to 2050*".

Targets for the electrical sector in the Member States:

1. *to reduce CO₂ emissions* by 57-65% by 2030 compared to 1990 level and by 96-99% by 2050;
2. security of *supply*;
3. remain *competitive* with competing markets.



The responses in the most important European countries

14

To reach these objectives, the most important European countries are developing their own strategies:

1. **Germany**, abandonment of nuclear power by 2017 and 100% renewable energy by 2050;
2. **France**, has evaluated various settings by 2030, tending to the life extension of power plants and their gradual replacement;
3. **Great Britain**, decided to install 16 Gwe of nuclear energy, supported by experiments with CCS and development of renewable energies.



One year after Fukushima: rethinking the future

G.Zollino et al, AIN Scientific Council

IEA Energy Technology Perspective

target: 50% cut in Energy CO2 emissions by 2050

15

	Costo di Impianto [\$/kW]		Costi Es & Man [\$/kWa]		Efficienza netta [%]	
	Anno 2010	Anno 2050	Anno 2010	Anno 2050	Anno 2010	Anno 2050
Carbone USC+ CCS post comb	3400	2500	102	75	36	44
IGCC + C CS pre comb,	3200	2450	96	74	33	48
Nucleare Gen III+	3400	3000	100	90	36	37
Geotermico	4000	2900	220	136		
Solare PV	4500	1300	50	13		
Solare CSP	5700	2500	30	15		
Energia marina	4000	2200	120	66		
Eolico onshore	1800	1400	51	39		
Eolico Offshore	3300	2300	96	68		



One year after Fukushima: rethinking the future

G.Zollino et al, AIN Scientific Council

	2050 Scenarios in the power sector					
	Base-line world	Base-line UE	Blue-map UE	Blue-map world	Blue-map world+nu c	Blue-map world+res
Production [TWh]	46000	4800	3600	40000	41000	37600
Nuclear [%]	10	16.7	29.3	24	39	12
Oil [%]	1	0.1	0	1	0	1
Coal [%]	44	13.3	0	1	1	1
Coal+CCS [%]	0	0	11	12	8	2
Gas [%]	23	30.4	1.5	11	7	8
Gas+CCS [%]	0	0	3	5	4	2
RES	22	39.4	54.1	48	42	75
Average cost of electricity in comparison with baseline				+19%	+6%	+31%

EU Energy Roadmap 2050:

What about Italy?

A model for power generation in Italy by 2050

18	Tecnologies	Overnight costs €/kW - 2010	Overnight costs €/kW - 2050
Investment costs	Gas CCGT	790	640
	Gas CCGT+CCS	1510	860
	Gas OCGT (<i>back-up</i>)	450	400
	Coal USC	1600	1300
	Coal USC+CCS	2660	1830
	Nuclear	3550	2500
	Biomass	2950	2820
	Wind onshore	1750	1670
	Wind offshore	3130	2600
	Wind float offshore	3825	3250
	PV	3100	2300
	CSP	3750	3190
	Hydro storage	715	715
	Batteries NaS	3000	2400

A model for power generation in Italy by 2050

Power generation mixes

Tecnologia	BaU		Blue-CCS		Blue-NUC		Blue-FER	
	%	[GW]	%	[GW]	%	[GW]	%	[GW]
Gas CCGT	59,9%	55,3	0,5%	0,5	0,5%	0,5	0,0%	0,0
Gas+CCS	0,0%	0,0	33,0%	34,7	22,4%	23,5	17,1%	18,0
Gas OCGT	0,6%	1,9	0,7%	2,1	0,7%	1,9	3,1%	8,9
Coal	14,9%	11,5	0,0%	0,0	0,0%	0,0	0,0%	0,0
Coal CCS	0,0%	0,0	33,0%	19,5	5,6%	3,3	4,3%	2,5
Nuclear	0,0%	0,0	0,0%	0,0	42,0%	22,1	0,0%	0,0
Biomass	3,3%	4,2	4,1%	4,4	3,8%	4,2	4,3%	4,7
Geothermal	1,5%	1,1	2,1%	1,2	1,8%	1,1	2,4%	1,4
Wind onshore	3,7%	10,0	4,8%	11,0	4,4%	10,0	5,2%	11,9
Wind offshore	0,8%	1,5	1,2%	1,9	1,0%	1,5	1,4%	2,3
Floating Wind	0,0%	0,0	0,0%	0,0	0,0%	0,0	2,4%	3,3
Photovoltaic	5,1%	23,0	6,5%	25,0	5,7%	23,0	11,2%	108,3
CSP	1,0%	1,1	2,9%	2,7	1,2%	1,1	21,2%	19,5
Hydro	8,7%	17,8	10,6%	18,6	10,1%	17,8	11,1%	19,4
Storage	0,5%	7,7	0,6%	7,7	0,8%	7,7	17,0%	71,4

Power generation/load in one day of August 2050

75% RES power

20

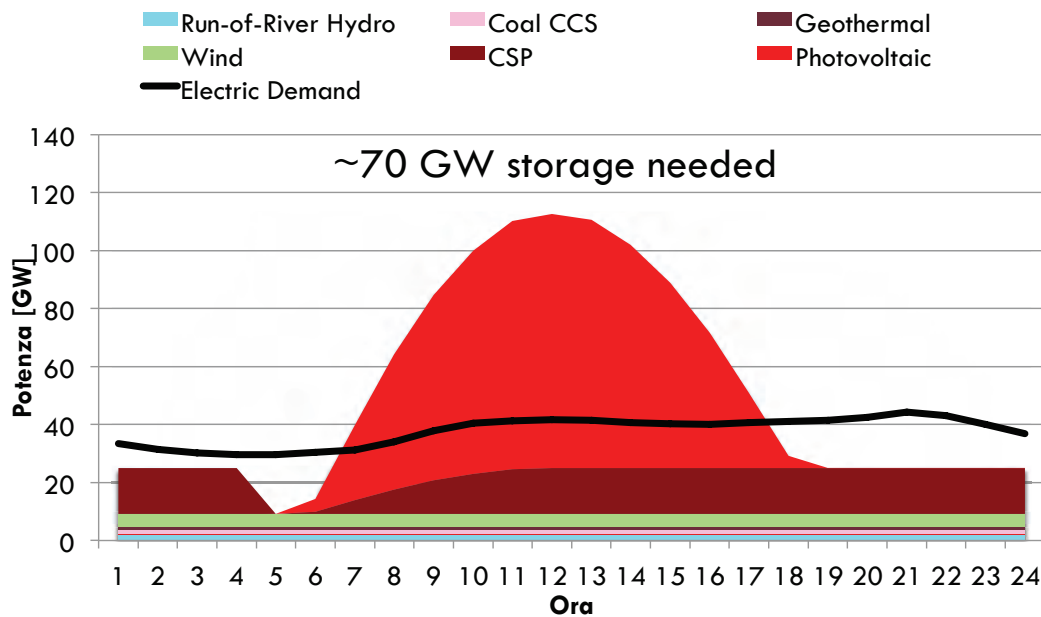

One year after Fukushima: rethinking the future

G.Zollino et al, AIN Scientific Council

Power generation/load in a winter day in 2050, fully cloudy weather – 75% RES power

21

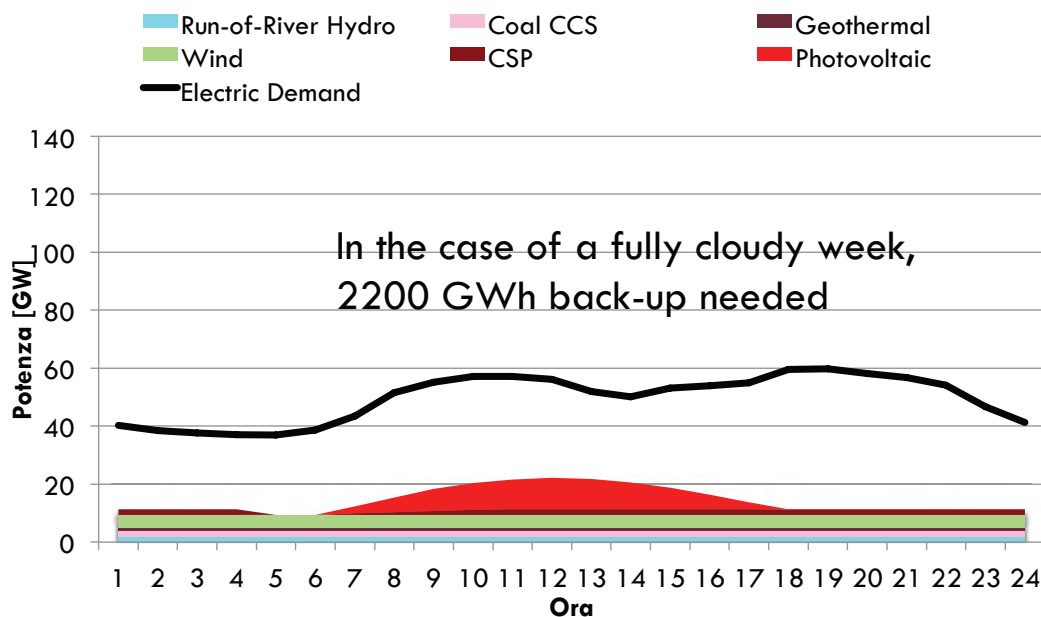

One year after Fukushima: rethinking the future

G.Zollino et al, AIN Scientific Council

Probabilistic analysis of the average cost of electricity production in Italy in 2050

22

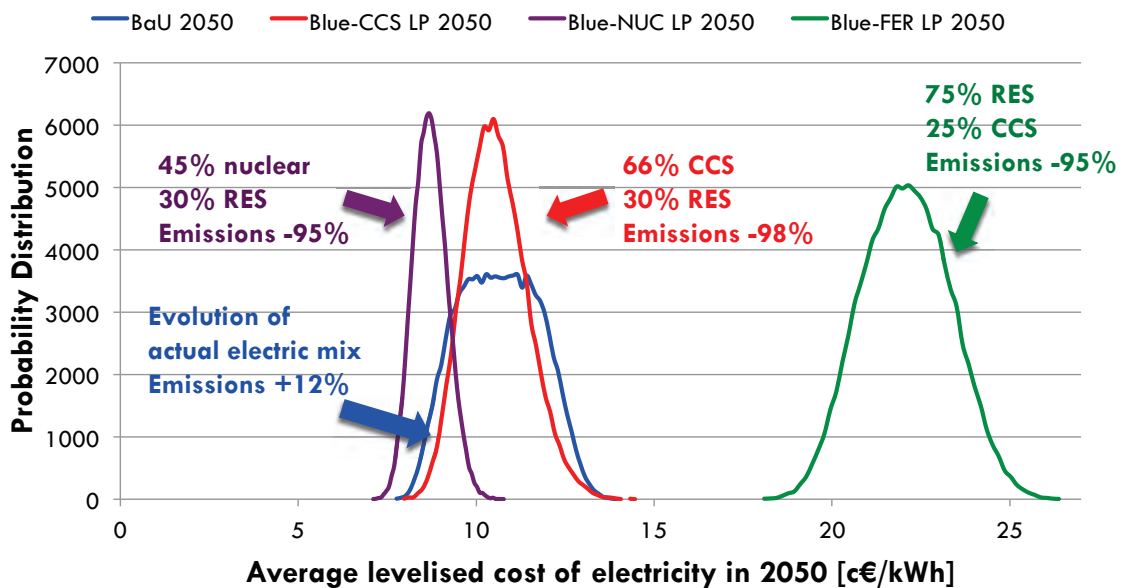

One year after Fukushima: rethinking the future

G.Zollino et al, AIN Scientific Council

23

*"This joint declaration will signal our shared commitment to the future of civil nuclear power, setting out a shared long term vision of **safe, secure, sustainable and affordable energy, that supports growth and helps to deliver our emission reductions targets.**"*

Statement from the office of UK Prime Minister, David Cameron, after the signing with French President, Nicolas Sarkozy, on 17 February 2012, of a landmark nuclear new build deal



One year after Fukushima: rethinking the future

G.Zollino et al, AIN Scientific Council

Published by ENEA
Communication Unit
Lungotevere Thaon di Revel, 76 – 00196 Rome
www.enea.it

Cover design: Cristina Lanari

Printed in October 2012 at ENEA Frascati Research Centre



ISBN 978-88-8286-273-2