



IARP
International Advanced
Robotics Programme

ENEA

Agenzia nazionale per le nuove tecnologie,
l'energia e lo sviluppo economico sostenibile

DOSSIER

ROBOTICS IN ITALY

Education, Research, Innovation
and Economics outcomes

2013

*Ambiente
Energia
Innovazione*

Dedicated to the memory of Georges Giralt, for its effort in support of the international cooperation in robotics, for strong determination in increasing the governmental links through the IARP organisation, for its personnel and precious friendship that he conceded to me.

With sincere friendship, Claudio Moriconi

ROBOTICS IN ITALY

Education, Research, Innovation and Economics outcomes

Silvia Bossi, Angelo Cipollini, Ramiro dell'Erba, Claudio Moriconi

2013 ENEA
Italian National Agency for New Technologies, Energy and Sustainable Economic Development
Lungotevere Thaon di Revel, 76
00196 Rome

ISBN 978-88-8286-296-1

Cover pictures

1. *Astromobile, SSSA, 2012, Photo by Massimo Brega/The Lighthouse*
2. *Mascot, ENEA, 1987*

Foreword by the ENEA Commissioner



Introducing the result of this new initiative of the Agency, I cannot help recalling the early stage of the automation and robotics technology ENEA has contributed to build up in Italy.

ENEA was the first research body in Italy and in Europe to develop in 1959, when it was called CNRN, what is perhaps the pioneer of modern robots: the Mascot teleoperator.

Designed as a manipulator controlled by a human operator from a very remote control console, Mascot allowed to manage the very dangerous fissile materials, avoiding man's exposition to nuclear radiation. The performance in sensitivity of operation reached by the Mascot family remains unsurpassed yet, after 60 years and after all the technological progress that the robotics community has been able to build up.

I am therefore proud to present this volume, which demanded a detailed and long preparation; and it is not by chance that, in these days of competitiveness, ENEA is still in charge of analyzing the scenario of the Italian research centers' network, that is working at the highest levels in the whole world.

The Report offers a number of points which deserve an in-depth analysis to improve the efficiency of research in this interdisciplinary science at the national level, being many of these adopted not only for robotics but for most of the high-tech disciplines in Italy.

I do hope this new product of the Agency will greatly contribute to relaunching research and high-tech industry in our Country.

Giovanni Lelli

Index of topics

<i>Letter to the Italian Robotics Community</i>	7
<i>Executive Summary</i>	8
<i>Aims of the Report</i>	9
Some considerations about the importance of Robotics and of automation developments	10
Structure, strength and criticalities of the Italian research operators	12
Characteristics of the national industrial operators in robotics and automation field	14
Strength and possible improvements in the education system	14
<i>Main Robotics areas and players in Italy</i>	17
<i>Descriptive cards and interviews with the visited Institutes</i>	19
<i>Liguria - One of the most important poles of robotics</i>	21
CMRE - Centre for Maritime Research and Experimentation	22
Introduction	22
Educational activity	23
Research	23
Funded projects	24
Other activities	25
Facilities	26
Main results (papers and realizations)	27
The Foundation “Italian Institute of Technologies” (IIT)	32
Introduction	32
Policy of the body	33
<i>Turin area - The integration between Industry, Academy and Education</i>	35
Some notes on the Area features	35
DAUIN, DIMEAS - Polytechnic of Turin	36
Introduction	36
Research	37
Main results (papers and realizations of reference people)	38
<i>North-eastern Italy - The research pole of the most industrialized area of Italy</i>	39
Airlab, Merlin, Nearlab, Cartcas - Polytechnic of Milan	40
AirLab	41
Merlin Group	43
Nearlab	44
Cartcas group	46
Main results (papers and realizations of reference people)	47
University of Bologna	49
Introduction	49
Educational	50
Research	50
Funded projects	51
Other activities	52
Facilities	52
Publications	52
Altair - University of Verona	54
Introduction	54
Main results (papers and realizations of reference people)	56
UniTrento - University of Trento	57
Introduction	57
Educational activity	58
Research	58
Funded projects	59
Other activities	60
Facilities	61
Team	61
Publications	62
<i>Tuscany - An excellence in Italian robotics</i>	63
The Biorobotics Institute - Scuola Superiore S. Anna	64
Mission	65
Introduction	65
Areas of interest	65
Cooperation and collaboration agreements	66
Educational activity	68
Considerations	68
Main results (papers and/or realizations of reference people)	69
The E. Piaggio Institute – University of Pisa	70
Introduction	70
Areas of Interest	71
Cooperation and collaboration agreements	72

Educational Activity.....	72
Main results (papers and/or realizations of reference people).....	73
<i>Central Italy</i>	75
DII – Università Politecnica delle Marche	76
Introduction.....	76
Educational activity.....	77
Research.....	77
LabMACS activity	78
Available facilities	79
Publications.....	80
DIEI – University of Perugia.....	81
Introduction.....	81
Research.....	81
Cooperations	82
Publications.....	82
<i>Rome - One of the largest areas of research industry and education in robotics</i>	83
ENEA: UTTEI Rob	84
Introduction.....	85
Educational activity.....	86
Research.....	86
Funded projects	87
Available facilities	89
Publications.....	90
Finmeccanica.....	91
DIAG – Sapienza, University of Rome	94
Introduction.....	95
Lab Ro.Co.Co	95
ALCOR Lab.....	96
ROBOTICS Lab.....	97
DIAG Current Projects.....	99
DIAG Past Projects	99
Education	99
Team	100
Spin-Off	100
Publications.....	100
University of Rome Tor Vergata – DISP	102
Introduction.....	102
Educational activity.....	102
Research.....	103
Other activities	103
Team	103
Publications.....	104
University Campus Bio-Medico.....	105
Mission.....	105
Introduction.....	105
Scientific results.....	106
Facilities	107
Collaborations	108
Projects.....	108
Education activities	109
Team	109
Mondo Digitale.....	111
<i>Southern Italy - A most interesting integration among research, academy and</i>	
<i>Public Administration</i>	115
PRISMA-LAB.....	116
Mission.....	116
Introduction.....	116
Scientific results.....	117
Collaborations	118
Projects.....	120
Education	120
Suggestions/Criticalities.....	121
Publications.....	121
CNR-ISSIA	123
<i>Catania – The image of close cooperation between school, University and High Tech Industry</i>	129
University of Catania – DIEEI	130
Main results (papers and realizations of contact persons).....	133
ST Microelectronics	135
<i>A short analysis and a proposals for an Italian Robotics network</i>	137
<i>Conclusions</i>	139

Letter to the Italian Robotics Community



Dear colleagues and friends,

this job, that I started last year in 2012, is far from its conclusion and is far from the original aim to depict a reasonably complete frame of the Robotics research in Italy. Trip after trip, visit after visit, the huge amount of information, the understanding of the many existing situations, the requests that many of you addressed to me, increased to become a corpus. This has forced me and the group that ENEA built up for this task to take a painful, but also more ambitious decision: to leave the original idea of realizing a single book with an exhaustive view of the national research and to compose a document that will be printed in time to be still valid in term of information

despite of its incomplete state, and that will be improved year after year with the contribution of all of you. Final goal will be to represent a picture of the Italian capabilities in this huge research field to foster and encourage the Italian enterprises of any dimension to reserve their place in the world with the awareness that they can count on a strong and worldwide recognized national knowledge.

For this reason some of you will not find their work on this first edition and some other will be reported only on the basis of known and published results and news, but without the direct interview that to me is the base to thoroughly represent the work of a research Laboratory or of an high tech enterprise.

I was really regretful for this, but this is just a beginning and, beyond the publication of future and more exhaustive reports, we are already working to realize an interactive internet portal that we will offer to the whole community and to the whole national industry and that will contain, besides many other functionalities, the most recent version of the Italian White Book of Robotics.

It is my duty to remember that this work was conceived in the frame of the Italian commitment towards the international robotics community expressed through the membership to the International Advanced Robotics Programme (IARP) that I am proud to hold on the behalf of our Country.

IARP Chairs have already expressed their huge interest for the work that we have carried out and there is the proposal that this plan could become the reference model for the IARP operation in the next years.

Finally I would like to thank all the people, in ENEA and out, who gave their contribution, and will hopefully continue to participate in the future, to the effort to increase the cooperation and the representativity inside our nation. This book is only the first step of our effort. Without the cooperation of the Italian robotics community, this work would be not possible. Thanks to everybody.

Claudio Moriconi

Executive Summary

This Report has been conceived and written under the auspices and the support of the International Advanced Robotics Program, an intergovernmental association that includes, beyond Italy, some of the most advanced countries in Robotics discipline (main are USA, Japan, Korea, China, Germany, France, Italy, Spain, United Kingdom, Poland, Russia, Canada, Belgium, EU as Observer).

Our job was aimed at drawing an overview of the research in robotics in Italy, collect the opinions of the operators about the connections with industry leaders and the national and international market perspectives, study the actions to be carried out to improve the education of young students in the science in general and in robotics in particular.

The Report will also try to identify the strength and the weak points of the Italian robotics community system and propose some possible actions to stimulate and increase the competitiveness at European and Worldwide level. Inexpensive actions will be proposed to be carried out both by means of independent initiatives inside the Community and by means of ruling action of the Public Administration. The aim is to facilitate the level of cooperation and to improve the effectiveness of cooperation among school, research and enterprises.

The different realities in Italy (Academies, small and large Industries, education operators, associations of stakeholders) have been contacted, visited and discussions on different scientific and marketing themes have been carried out.

A number of excellence canters in all classes have been described in the Report in order to allow the reader to have an idea of the complexity of the cultural tissue that Italy has developed in these years on this field. Automation and Robotics high level products are currently available in service, education, medicine, home, logistics (transportation and surveillance on the ground, aerial and marine environments), environment and many other fields at industrialised or preindustrialised phases.

Currently, the most significant brake to enterprise initiative comes by the lacking of credit while the potential is at the moment highly competitive with other international realities. The report shows that Italy is still one of the major players at global level in this sector (4-6 ranking in the world) in terms of research excellence, industry production, market.

Some suggestions in short come out by the work.

- Increase the cooperation among the many resources available integrating the different groups coming from Universities, Research institutes and Industry. This could be greatly pushed on by the release of specific administrative rules able to facilitate associations/consortia among those subjects with a reduced bureaucracy. The birth of legal Consortia could represent also a powerful asset to reach a greater presence in the European market of research.
- Specific actions to introduce explicitly the automation inside the education programs of technical schools and to facilitate the cooperation among schools and companies. Many companies are already available to spend time and resources to create a tank of young and prepared technicians able to support the production.
- Definition of specific tools to drive the best students coming from the academies into the world of production by means of a new kind of organizations that can apply ideas and knowledge going out from the University into practical innovation problems supplied by the industry.

Aims of the Report

The Report wants to be a review of the possibilities that the Italian network of robotics can offer to the Country especially, but not only, in this crisis period. It is realized under the initiative and the responsibility of ENEA, perhaps the oldest Italian player in robotics, but couldn't be carried out without the support and the active cooperation of all the national operators, including Universities, Research Institutes, Large Industries, Small and Medium Enterprises, Foundations and other kind of Associations. It is to point out that this study has been pushed by the new initiatives of an international government association finalized at the cooperation on robotics known as IARP (International Advanced Robotics Program), where ENEA plays the role of representative on behalf of the Italian government. At the end of this Report a chapter will be devoted to the explanation of what IARP represents.

Most of the players in the national scenario represents an absolute excellences at worldwide level: Italian researchers in robotics have been (and are) leaders of the largest robotics associations, leads or co-leads most of the international research networks and are among the proposers of some of the most ambitious research projects.

Large Industries working in robotics are among the most important firms in the world.

Small industries, especially integrators, are able to push Italy among the first 5 places of robot builders in the world. Nevertheless it is to point out that robotics industry, in the whole, is not yet one of the main assets of the Italian economy.

The same situation can be observed in all the other advanced countries. The reason is that robotics has represented so far the means to produce billions of industrial products such as cars, agriculture machines, portable phones, computers, and so on: few units to produce a much larger number of product, but a niche market in itself. Also in security and military market, the number of the systems can be considered always very limited because of the intrinsic costs of machines like the drones or the robotized terrain vehicles.

Nevertheless the situation is changing, because automation and robotics are going into the final products and the next generation of cars and service machines too will be robots themselves with a dramatic explosion of the market. Italy has the opportunity to be one of the world leaders, but the current situation needs to be understood and compared to the one of the major competitors at worldwide level. The conditions for the exploitation of the full potential of the nations must be also created and maintained.

Therefore, the thesis and the challenge of this work is that Italy could catch a unique opportunity to transforms this potential into a powerful driver to find a stable position within this high-tech field. The operator's presentation does not want to be a sort of yellow pages book, but it offers to the reader the distinctive elements of each group and allows the formulation of new initiatives both on the research side and on the industrial side.

The authors (the whole community in fact) are well aware that each long duration action, finalized at producing also durable effects on the Italian society, cannot ignore that the basis of a successful result are based on the education of young generations to a valuable skill in the technical and scientific disciplines and are already active along this line. Currently, the efforts already on the way are still too sparse and too unlinked with the end users (the production system) to become a real driver.

Efforts are required also along this line to produce stable results and a study of what is undergoing will be also carried out. In the Report, an effort will be also carried out to address some allowable actions. Most of them could be performed under the initiative of the players without any other push from the Public Administration. Other could be facilitated by some ruling action of the government.

Some considerations about the importance of Robotics and of automation developments

Is robotics an asset for our Country?

This is the first question to cope with to understand the meaning of the present study.

Typically a great emphasis is given to “romantic” visions of robotics like the ambition to reproduce an artificial life or the objective to realize a sort of intelligent “slaves” able to assist the humankind in every phase of its existence. Sometimes robots are depicted as potential threats.

Apart from ethical considerations that are anyway discussed by some research groups (i.e. “Scuola della Robotica”¹), what we want to shortly discuss here is based on reasonable economic considerations and on the analysis of markets.

Italy is still, at this moment, the fourth worldwide market of robotic devices and the fifth producer. This ranking is subjected to fluctuation, but it is more or less still on these places since many years.

Most of the production is concentrated in the arms designed for automotive application, but a considerable amount of business is also realized by small and medium enterprises that integrate components and subsystems produced in foreign countries (typically Japan, Korea and Germany).

These final products are featured with high level characteristics and most of the times are carefully tailored around specific industrial needs so that they show a great efficiency in the practical applications. A typical example can be the production of robots for the wood industry, where the Italian producers are the top sellers in the world. The excellence of the products comes from the excellence of the wood manufacture more than from a top position in robotics component production.

Nevertheless the whole sector is an asset to get higher level positions in other productions (furniture, automobiles, etc..) more than a richness in itself. It was since several years and remains a niche market. The Italian fashion market, for instance, is much more important and large than the robotics one.

The production robots have been the starting point and the first step for the evolution of robotics. The second step is generally accepted to be the “service robotics”. Despite there are several definition to define this next technological step, we can accept that it can generally address a generation of intelligent working machines. Under this point of view it could also be seen as an evolution of existing cranes, up lifters, tractors and many other utility machines. The new releases could become faster, error proof, higher precision maintaining or not the human presence and supervision. The final product result could be a strong increase in productivity and quality of service (QoS) without the loss of working places. The technology required for this step is already available and is well owned by the Italian research stakeholders. A massive technology transfer towards SME and LE could be possible providing that suitable conditions can be arranged. What is important to point out is that the market dimensions are no more the ones of the building of products, but those of products themselves with a difference of several orders of magnitudes.

The automotive industry can be one of the more natural targets of “service robotics” and could be the focus of such a revolution (there are already many examples of robotics functions embedded in medium and top class cars like the self parking function), but the full exploitation of this particular market is subjected to the rules of each government in order to the safety of the citizens with respect to an innovative technology and the needed authorizations could be slow. On the contrary other products could become more rapidly a significant market. One significant example is the robotics applied to the support of medical cares (among the images in Fig. 1).

¹ Is a no profit organisation born in 2000 in Genova for the knowledge of Robotics by a group of robotics researchers and of scientists of human ethics for the study of impact of robotics on human society.



Production



Service



Entertainment

ROBOTS



Domestic

Fig. 1 - Example of different robot types: production, service, entertainment and domestic robots

The third step is most probably the entertainment market. Sony was one of the forerunners with Aibo and other toys, but its first experiences were probably affected by some limits in the adopted technology and by a wrong market segment choice. Currently many limits have been overcome, more sophisticated and low cost controls are available and the “killer application” is much easier to be found. Examples are already available even in some Italian advanced research centers, practically ready to be transferred to the market.

The fourth step is probably the domestic robotics. The dimensions of this market are astoundingly large. They can be probably compared with the automotive industry. It is to be understood that domestic robotics is definitely NOT domotics. This last term is reserved to relatively easy automation appliances like intelligent lights, remote switch of existing devices (washing machines, dishwashers, electric heaters) and so on.

The Roomba explosion is a relatively easy approach, requesting just a wandering machine and a light vacuum cleaner, but more demanding tasks, like the handling of dishes from and to the table or the dishwasher at a relatively low price, ask for a much more developed intelligence and for a considerable handling capability. It can be achieved with the current technology, but with costs out of the targeted market.

UNECE (the UN organ for market provisional analysis) stated that according to its own forecast analysis the world market of robotics should be at an explosive point reaching, despite the

international crisis, to a level of about 70 billion euro within the next two years were the most growing part should be represented by service and medical robotics (with respect to a slowly growing market for industrial robotics).

The conclusion is that, definitely, robotics is or can quickly become an asset for our Country. Italy has a top level know-how at research level; the dimensions of many potential operators are suitable for much profitable investments; finally the market (in term of population) is already mostly sensitive to high tech products.

Structure, strength and criticalities of the Italian research operators

This discussion comes from the interactions that ENEA had with most of the research leaders and therefore the topics here presented cannot exactly describe the situation of each single center with few exceptions. Usually the Italian research groups in Robotics, with the prominent exception of IIT and BioRobotics Institute, share the commonality of a relatively small dimension: the number of people that are engaged in laboratory or theoretical activities is generally in the range of 20-40 people, considering that most of them are often students of the universities. There are situations in which a single very high skilled professor has to coordinate the activities of 20 or more young students or post docs. Even CNR and ENEA have similar numbers also if there is a substantial difference in the composition of the research teams: there is a greater presence of permanent staff and a much more limited availability of young researchers that can be obtained with a very great difficulty for the currently applied rules.

On the contrary, in foreign Institutes dimensions greater than 100 researchers are quite a common situation. Just to remain in our closer European state, France, CNRS, CEA, INRIA count more than 150 researchers each one on the robotics laboratories. Many other research centers are in similar positions and also labs founded by Universities are often of significant dimensions. For instance, Laboratory for Computer Science, Robotics and Microelectronics of Montpellier, can afford on almost 400 workers and a significant part of them is concentrated on the robotics topics. Outside of Europe, without mentioning the Japan and Korea, there is the case of Melbourne University with about 200 students and teachers and the Vancouver University with the same values. Still IIT and Biorobotics Institute (Scuola Superiore Sant'Anna) in Italy are on the lower limits of these dimensions.

Therefore, one the major problems of Italian research groups is in their dimensions This makes extremely difficult to have in the same place all the skills requested for horizontal technology like robotics is. Therefore, the knowledge is dispersed along a great number of very active, but limited to very specific topics.

The logical consequence of this situation is the connection among several operators in order to achieve the requested number of skills to cope with complex and advanced projects. We can found quite often connection like these; for instance only few of these examples can be:

- IIT and Polytechnic of Turin for space robotics;
- IIT, Pisa University and S. Anna Institute) for humanoids and biological robotics;
- ISME, the interuniversity consortium for marine robotics made by University of Genoa, Trento, University of Pisa, S. Anna, University of Marche, University of Cassino;
- ENEA with University of Roma Tor Vergata and University of Perugia for again underwater robotics;
- BioRobotics Institute with WASS and Pisa University for coastal inspection and pollution monitoring.

Need for a national coordination body (association / consortia / others). Despite the advantages this situation is not always positive: several times it can create further problems at European level. In fact the participation to European projects implies a reasonable equilibrium in the number of participants for each country so that a cluster of bodies like the ones that are requested in Italy creates immediately a strong unbalance towards the other member states: this makes the project less attractive.

There are many other unpleasant consequences that comes from the limited dimensions of Italian groups, including some difficulty in exchanging experiences, in cooperation among far bodies, the lacking of stability of know-how caused by the short permanence times of the researchers inside their original groups and the high percentage of them that can be lost during the job research. This last topic will be analysed in more detail in the following because other possibilities to recover the situation could be experienced.

It has been suggested that the realization of a new legal body, with the capability to attract the partnerships of the Italian academies, of the Research Institutes and possibly of few high tech SMEs could create a viable solution to smooth many of these problems. Similar examples have been already realized in Italy: we can mention here the Italian national consortium for telecommunications (CNIT) and the Italian consortium for marine sciences (CONISMA). Usually they are limited to universities, but this body should have features that are more general because the Robotics community includes a significant number of non-academic public bodies with similar problems (CNR, ENEA, Kessler Foundation, IIT, NATO Undersea Research Center) that could be part of the network.

The possibility to give founding to a similar Consortium is currently under discussion. Examples of small associations like ISME and, under some extent, PRISMA exist also in robotics community.

A less heavier task, with much more limited aims, that has been also the focus of some debate with many academic people, is the creation of a Stable National Informatics Forum on Robotics. This initiative couldn't solve most of the before mentioned problems, but if supported by a volunteer partnership could offer several opportunities to many little groups for a greater integration in the community and to facilitate the connections before mentioned among bodies with different specializations.

Loss of know-how. The reduced dimensions of the research groups, together with another well known problem of the national research, the small number of new high-tech firms that are generated around the main centers, is the origin of another critical problem.

Discussions carried out so far with the managers of the research groups highlighted that some research bodies, especially academic organization, are in trouble in maintaining a growing know-how on the research themes. The maintenance of a know-how that can be transferred to industry is critical for two main conditions: the opportunity to develop a scientific line by means of new projects that can continue on the same line and the capability to keep the skills developed on a previous project for a reasonable amount of time after the project itself ended. Those conditions are seldom satisfied and the result is that, after brilliant scientific successes, the research organization is often not in condition to support adequately the industry having loosed the main actors of the research that will go to foreign states in the best cases or are forced to accept low level jobs in the worst.

In different realities young researchers are largely absorbed by the surrounding industrial infrastructures, that are typically close high tech small firms strongly linked to the University and/or to a Research Institution.

In this way the developed know-how can be easily recovered and applied again to new economic needs or to maintain a leadership in further scientific projects.

In the Italian environment this situation can be viewed as an exception more than an usual condition and the know-how is often definitively lost and if absolutely needed it must be recreated since the beginning, with a very important waste of investment.

It can be roughly calculated that each year Italy loses an amount not much less than 10 M€ in terms of education and researches lost. It is much more difficult to evaluate the corresponding missing payback in terms of investment of those potential results, but a prudential evaluation could lead to evaluate a figure 10 times greater of market lose only for robotics.

Possible solutions to reduce the impact of such situation are not easy to find. A preliminary evaluation arisen during the study brought us to devise a mechanism to extend the “know-how availability” at zero or very low cost for the public administration.

Characteristics of the national industrial operators in robotics and automation field

Industry involved in robotics in Italy can be divided in three large sections:

- a) Large Enterprises (COMAU, PRIMA, FINMECCANICA, STM and few others). They are characterized by the dimension and by the possibility to support a significant internal design capability;
- b) Integrators. They represent a large part of the global activity in robotics and produce innovative robots on the basis of the application by the customization of arms, software and components produced in other countries (typically Japan, Korea and Germany);
- c) SMEs. This area presents a very articulated scenario with profiles ranging from high tech production (quite often supported by young entrepreneurs coming out from the academies) to service sellers that use robots to offer services to traditional or new market targets like public administration (i.e. local authorities, security authorities, army and so on) or second level service industries (i.e. cleaning companies, environmental control firms and so on).

The only true global player of large dimensions is currently COMAU, that is the FIAT robot producer and therefore strongly oriented to a very specific market area also if a wide one.

Strength and possible improvements in the education system

It is important to underline that we intend to consider here only practical elements, relevant to the spreading of specialist skills and culture in robotics and automation jobs within the Nation. The general problem of the education system in Italy is of course largely outside of the aims of this work and is exclusive competence of the Italian government.

Also we will limit the discussion to two possible areas to avoid to enlarge too much the analysis in this job: the possible approach to establish regular interactions among Research Centers and Schools (lower grades education institutes) and the problem of the transit of young engineers to the world of work. Also within these boundaries we don't pretend to find universal solution, but only to present themes and possible approaches arisen during the interviews with many top level representatives of the Academic and Research world.

As far as it concern the lower grades education, from the grade schools up to secondary schools. There are currently several initiatives that are focused to the exploitation of robotics, especially on the technical schools, to increase the participation and involvement of young students in the scientific studies. Among these initiatives we can mention the “Rete della robotica”, promoted by the Mondo Digitale foundation (see Mondo Digitale) and signed in Rome by about 80 members including research institutes, academies and schools; the similar initiative of the Piedmont Region, limited to the area of the region, but with an heavy involvement of big players like COMAU and c; the “rete di scuole per la Robocup Jr Italia”, signed by a group of about 20 Technical Institutes, that is organizing a national event to support the competitiveness spirit in young students to create and produce automation (Robocup) and compare their result with the ones of other schools.

These initiatives are largely based on the volunteer work of a high number of teachers and this kind of situation is most probably largely diffused within the nation. It is expected that there is a huge potential in integrating the existing educational offer with an additional “competitive” offer, where the scientific education is conjugated with the stimulus to the contest approach.

Nevertheless, the possibility to reinforce and exploit at best this potential should be extended to the whole Country and the efforts of the volunteered personnel has to be framed in a general ruling system. This line of action could offer the opportunity to grant to all the students similar opportunities and to all the involved teachers (typically electronics teachers) the capability to enhance their professional skill following stages organised by the Ministry in cooperation with Universities and research centers all along the national territory.

Currently, the aforementioned Region of Piedmont is trying to design a similar method and, after some testing time, to support the approach at national level.

The costs associated to this procedure much depends by the followed approach. If the staging activity is accepted as advantageous for secondary school and University professors (what is currently unforeseen) and the use of public infrastructures becomes mandatory more than a possibility, as it currently is, such an approach becomes more and more effective.

High-tech industries are looking for skilled young people in many robotics and automation areas and the opportunity to get a greater offer will push several entrepreneur to lend facilities and tutors. This has been already discussed within the many interviews carried out by the authors during this work and also in other public circumstances (meetings, presentations, etc.).

The second important issue that we considered takes into account the final phase of the education course.

In particular the idea is to find a way to increase the job opportunities for young an engineer that comes out from the Universities with a little possibility to find working places. This is a quite hard problem that has been enhanced and worsened by the current long duration crisis but that was anyway endemic in the industrial national market.

The analysis that we carried out is based on the observation that the cost of the training “on the job” for the industries is often quite high and that this phase is a must in many cases, owing to a persistent distance between the academic instruction and the practical needs of the industrial approach, also when we talk of high-tech companies.

To cover this distance, many large firms adopted, in the past, the solution to specialize the incoming personnel by means of internal courses. In some cases these integrative courses were at a very high level and carried out by well known Academic professors. Perhaps the most important example was the “Scuola Superiore Reiss-Romoli”, built at the outskirts of L’Aquila in 1976 by STET, the national agency for Telecommunications, and closed in 2009 after the large earthquake that caused so many destructions in that territory.

Currently these facilities are no more available in almost all of the cases. The cost of this solution and the characteristics of the work market, more oriented towards a great flexibility than to building strong and specialized skills, discouraged this approach. The large industry is often pushed to exploit the worldwide offer to cope with the request of skilled people, more than train domestic high level young people whereas the SME’s, in most of the cases, do not have the strength to invest in long term lines, often preferring to invest on the final solution more than on the capability to develop. What has been discussed with many research representatives and can represent a possible approach is the realization of a new, semipublic or public body supported and participated by existing operators in the way detailed hereinafter.

Objectives should be:

- the creation of an offer of excellence to PhD and high level engineers to limit the need of find a qualified job in foreign countries
- the realization of a research or innovation projects built on the needs of a specific industry. In this way the firm is able to realise its investment projects, without the need to hire people without the need to invest on them, to risk on the quality of the persons, to get obligations on the maintenance of the place if the market do not allow;
- the creation of new and permanent working positions within the industries interested in the projects, paid at a level compatible with the European standard; those positions can arise as industrial needs by the successful projects and that can be satisfied by the same persons that carried out the project. This creates a virtuous paths from the Academy to the Industry at least for the most skilled graduates and PhD;
- Realisation of an excellence structure able to compete at an international level with the strongest high-tech players.

Resources could be:

- the exploitation of existing facilities like laboratories, logistics infrastructures and administrative structures coming by Research Bodies (ENEA, CNR, IIT, INFN, Academies) and by specific local or national administrations (i.e. the ITech of Tecnopolo Tiburtino);
- the scientific leadership that could be assured by academy professors and top level research leaders coming by the Research Bodies, following protocols and agreements able to ensure them advantages in their professional development at no cost for the new structure;
- Facilities made available by the same industries interested into the projects;
- Contributions paid by the industries for the realization of the projects;
- Emission of Grants by Research Bodies to support projects were the same Bodies are involved or interested;
- Competition at international levels to get research funding.

Advantages for the supporter bodies could be:

- Participation to top class international projects through their participation to the new body;
- Decrease of the passive expenses connected to logistic infrastructures underexploited thanks to the lending of these structures to the new body that could partially pay for their maintenance;
- Increase of the efficiency of the administrative organization, that is sometimes oversized, thanks to the lending of services to the new body;
- Increase of the relationships with the national, but also international industry by means of the cooperation between the large and SME industry and the new body; in case of successful experiences the existence of the new body could considerably improve the confidence of industry in the public research organization, with positive spin off also on direct relationships between SMEs and public bodies
- Increase of the integration among Research Centers and Academy.

Some of the aspects to be faced are:

- the legal form of the new body that should allow the requested flexibility to operate efficiently with the private industry, still maintaining the capability to have a deep integration with its public supporters;
- the possibility of a public start-up funding to fix and define all of its operation modes and to settle down the new body in its operational places.

Some very preliminary agreements have been already carried out among ENEA and Rome Universities (mainly Sapienza) to study such a kind of organization for the needs of Robotics for Security. Nevertheless the proposal is worthy of a much larger application in Robotics and, generally speaking, could be applied to a large range of high tech activities.

Italian Research Sites

Main Robotics areas and players in Italy

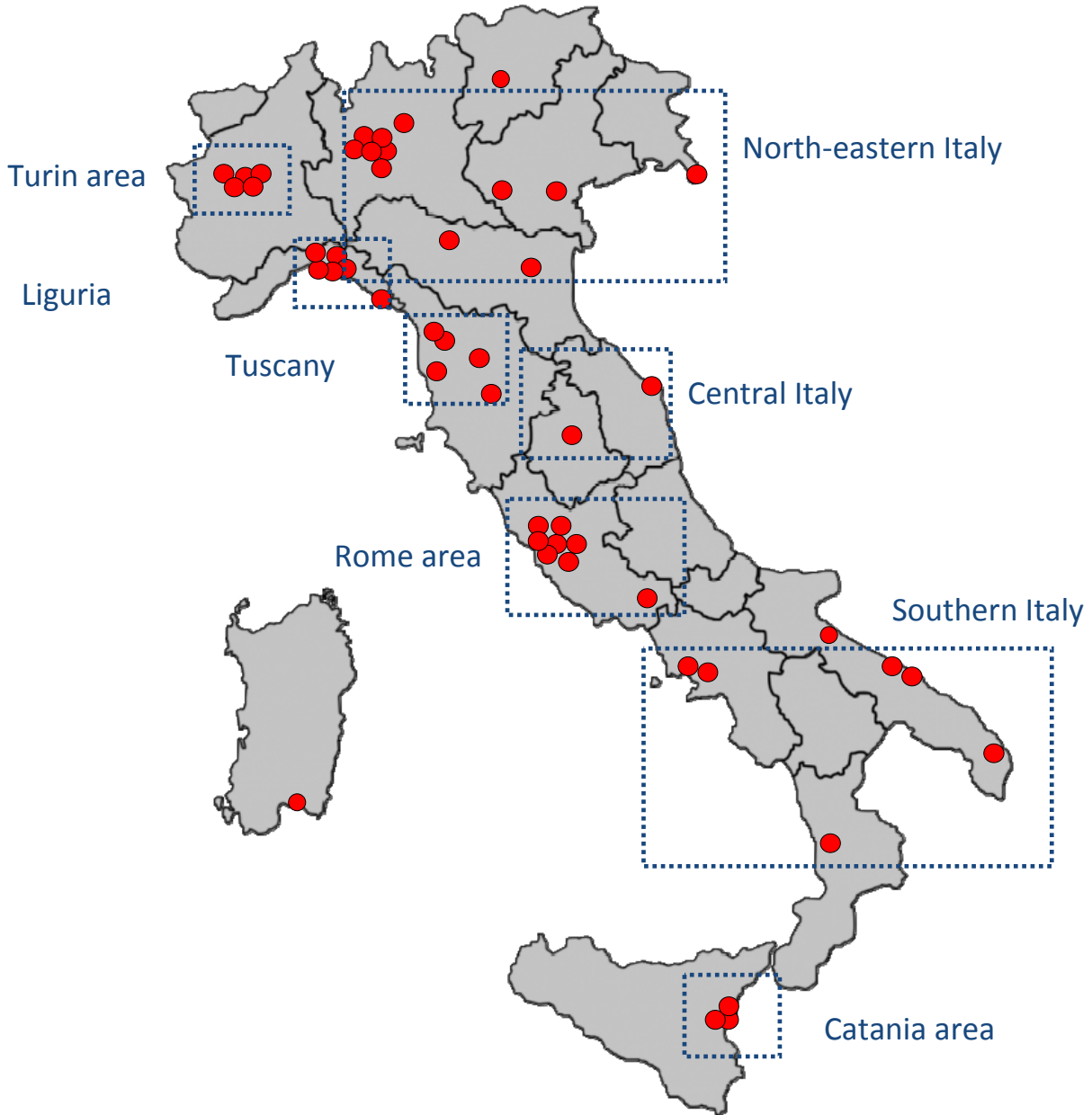

Turin area

Polytechnic of Turin
COMAU
PRIMA
Rete Robotica del Piemonte
Camera di commercio di Torino

Liguria

University of Genova
CNR – underwater robotics
Telerobot
Scuola della Robotica
IIT
CMRE

North-eastern Italy

Polytechnic of Milan
University of Milan
University of Milano Bicocca
UCIMU and SIRI
University of Verona
University of Pavia
University of Parma
University of Bergamo
University of Padova
University of Bologna
University of Trento

Tuscany

**Scuola Sup. S. Anna - The biorobotics
Institute**
University of Pisa (Ist. Piaggio)
Università di Siena
Università di Firenze

Central Italy

Università Politecnica delle Marche
University of Perugia

Rome area

University of Rome “Sapienza”
University of Rome “TorVergata”
University of Rome “Roma TRE”
University Campus Biomedico
University of Cassino
ENEA
Finmeccanica Group (TBD)
Fondazione Mondo Digitale

Southern Italy

University of Naples, Federico II
University of Calabria
Prisma
Bari
Lecce
CNR Bari
University of Palermo

Catania area

University of Catania
ST Microelectronics
Science City

Descriptive cards and interviews with the visited Institutes

Comments and keys of interpretation

The previous map shows the distribution of excellence centres in Italy. Because not all of them have received an interview to now we highlighted in bold characters those that you will find in this first version.

What follows is the base material that will depict the status of Italian activities on advanced robotics and is also the central Core for the report that Italy offers to the international organization IARP in which our Country is a member and is one of the original founders.

Because the cards have been realized with the important participation of the research organizations, we couldn't maintain a fully homogeneous format, but we made some effort to keep a reasonably coherence in the information, in the style, in the elements that are presented.

About the people photos, we follow the choice of the research group where available and in the other cases we choose to present the images of the most representative persons reported close to the publications they realized in the last years; in this case the person represented in the picture is the one *underlined* among the authors.

In the cards it is possible to find some figures that give an idea about basic information, contact information and dimension of the research group. Nevertheless please take into account that this data are only an approximate and indicative information: students and also professors are continuously varying inside a university group owing to the nature itself of the organization so that it is impossible to give precise values.

In many cases there are other groups that develop specific and much focused lines that could be considered inside Robotics, but we didn't mention them because could be below a minimum dimension or because robotics is not their main activity.

As already said this document is intended to be a "living" document. It will be found in the ENEA's site and all the contributors will have the opportunity to modify the information with the support of an ENEA's group to maintain the on-line document up to date.

In addition the visits to the research groups and to the industries will continue to extend and increase the usability of the report.

Liguria

One of the most important poles of robotics

Traditionally, Genoa and Liguria more in general, has been one the most active Italian poles in robotics and this happened for several reasons.

The first is perhaps the existence, since the beginning of a strong industry in the nuclear field (Ansaldo, NIRA, ELSAG, etc...); as in the case of the ENEA's public body, the nuclear technology was a powerful drive for several technologies, including the original robotics (basically founded on teleoperation).

The second is the presence of a large University that was able to collect and support the needs of the industrial groupment and to act as a cultural flywheel during the phases of slowdown of the local industry interest in robotics and, after the failure of the nuclear industry in Italy, to stimulate the SMEs to receive this heritage and to look for other market niches, especially after the turn of the Century that opened the Era of service and personal Robotics.

The third is represented by the funding and the policies of the Liguria Region. This Region choose to select the Sea technologies as reference technological district and pushes on all the technologies connected to this macro-objective. For this reason, after an intermediate time when the culture were still addressed by the old nuclear influence, the studies and the researches of the University groups, of Research institutes (especially CNR) and of many SMEs moved towards sea robotics technologies.

Currently apart from the case of IIT, that is driven by different (national) resources, the sea robotics represent an important asset in the research system of Liguria Region.

It is no easy to report a complete frame of the region operators, but the list of the main actors can be not far from the following one:

- Genova University (DIST department)
- Genova University (DIME department)
- IIT (Italian institute of Technology)
- CMRE (NATO)
- CNR (ISSIA)
- Telerobot (International Consortium)
- Oto Melara (Finmeccanica)
- MBDA (Finmeccanica)
- GraalTech (SME).

CMRE - Centre for Maritime Research and Experimentation

CMRE: Summary Table	
Institute	Centre for Maritime Research and Experimentation (CMRE) Viale San Bartolomeo, 400 La Spezia (SP) , 19126 Italy
Description	International organization
Reference person	Prof. Jean-Guy Fontaine
Contact	fontaine@cmre.nato.int pao@cmre.nato.int
Web site:	http://www.cmre.nato.int/
Working area:	Maritime robotics
Other interesting sites	
Senior researchers number	About 10
Total Group consistency (MV*)	About 40

Key Personnel:

Prof. Jean-Guy Fontaine: Head of Research Department at NATO Science & Technology Organization. Centre for Maritime Research and Experimentation CMRE

Introduction

The Centre for Maritime Research and Experimentation (CMRE) is a NATO scientific research and experimentation facility located in La Spezia, Italy.

The CMRE was established by the North Atlantic Council on 1 July 2012 as part of the NATO Science & Technology Organization, but the CMRE and its predecessors have served NATO for over 50 years as SACLANT Anti-Submarine Warfare Centre, SACLANT Undersea Research Centre, NATO Undersea Research Centre (NURC) and currently as part of the Science & Technology Organization.

The aim of the CMRE is to conduct maritime research and develop products in support of NATO's maritime operations; its focus is on the marine domain and on solutions to maritime security problems.

CMRE conducts state-of-the-art scientific research and experimentation ranging from concept development to prototype demonstration. The operational environment has produced leaders in ocean science, modelling and simulation, acoustics and other disciplines, as well as producing critical results and understanding that have been built into the operational concepts of NATO and the nations. This hands-on scientific and engineering research is conducted for the direct benefit of CMRE's NATO Customers.

The Centre employs about 150 people, composed of scientists and engineers who develop the prototypes. The scientists are generally recruited on a rotational system of three to five years.

The Engineering Department employs about 50 people, and they are dealing with robotics as well as materials and underwater acoustics.

CMRE is a leading example of NATO's Smart Defense Initiative where the nations come together to work more effectively and efficiently together, focusing on research and technology challenges, both in and out of the maritime environment. Through the collective power of its world-class scientists, engineers, and specialized laboratories, CMRE is on the cutting edge of ocean science and engineering.

Educational activity

The CMRE awards several internships and hosts students for periods ranging from three or six months.

The Centre is active in sponsoring competitive challenges for students such as the Student Autonomous Underwater Challenge - Europe (SAUC-E) (see <http://sauc-europe.org/>). CMRE hosted the 5th, 6th, and 7th SAUC-E in 2010, 2011, and 2012 and it is planning to continue supporting the event. In 2012 the Centre hosted fourteen teams of university students and their autonomous underwater vehicles (AUVs), providing facilities and a venue in the La Spezia harbour (Fig. 2). The event was an opportunity for scientific and engineering students to gain real-world experience and interact with and share ideas with other university students and professionals in the field.

The SAUC-E was presented with the J. Guy Reynolds Memorial Award at the 2010 Maritime Systems & Technology (MAST) conference. Universities regularly obtain EU funding using the AUVs developed for SAUC-E. The success of SAUC-E contributed to the birth of the European robotics competition called eurAthlon (<http://eurathlon.eu/>), whose consortium includes CMRE. euRathlon will provide the scenario and the organization of world's first competition that requires autonomous flying, land, and sea robots working together to achieve a disaster response goal.



Fig. 2 - Student competition SAUC-E at CMRE

Research

The principal disciplines of research are described below.

- **Autonomous Security Networks** to address new capability challenges in the underwater domain, in particular submarine detection and mine countermeasures.
- **Active Sonar Risk Mitigation** to develop and apply the best practices for mitigating risk to marine mammals in the presence of active sonar.
- **Exploring Future Technologies** to advance technologies and concepts for Maritime Situational Awareness, Non-Lethal Port Protection, Maritime Security Operations.
- **Environmental Knowledge and Operational Effectiveness (EKOE)** to facilitate mid-to-long term Joint Intelligence and Reconnaissance in the maritime domain by developing an understanding of the operational environment.

CMRE's Engineering Department offers a full spectrum of specialized services, including research, development, testing and evaluation of concepts and technologies. A team of engineers and technicians offers full services, including design, modeling, fabrication, calibration and testing. Calibration and integration of heterogeneous system is a key factor.

Experiments at sea. With engineering facilities, two research vessels and a location on the Ligurian Sea in Italy, the Centre is able to conduct year-round research in the field. The 93-meter NATO Research Vessel Alliance offers researchers at the Centre and its partners an opportunity to conduct acoustic tests on one of the quietest ships in the world.

The Centre also has access to the Italian Navy's Coastal Research Vessel Leonardo, which is an excellent platform for shorter, smaller-scale projects. The competencies at the Centre include knowledge of ocean processes, relative to the communication, navigation and other activities in the interior of the ocean. CMRE's Engineering Technology Department (ETD) offers a full spectrum of specialized services, including research, development, testing and evaluation of concepts and technologies. A team of 40 engineers and technicians offers full services, including design, modeling, fabrication, calibration and testing. Calibration and integration of heterogeneous system is a key factor. Experiments at sea. With engineering facilities, research vessel and a location on the Gulf of La Spezia in Italy, the Centre is able to conduct research in the field year-round. The 93-meter NRV Alliance offers researchers at the Centre and our partners an opportunity to conduct acoustic tests on one of the quietest ships in the world.

The Centre also has access to the Italian Navy's CRV Leonardo, which is an excellent platform for shorter, smaller-scale projects.

Funded projects

AUTONOMOUS MINE SEARCH USING HIGH-FREQUENCY SYNTHETIC APERTURE SONAR

This project aims at increasing the capabilities of autonomous underwater vehicles by using synthetic aperture sonar to quickly and reliably detect, classify, and localize mines.

PORT PROTECTION.

The goal of this project is to increase NATO's ability to protect maritime forces, shipments, and assets against unconventional threats, including terrorism, in ports and harbours.

COMMUNICATIONS AND NETWORKS IN THE MARITIME ENVIRONMENT. This project develops technologies to enable "ad hoc" underwater communication networks and the connection of those networks with existing above-water wireless networks. Six Folaga Auv have been used and underwater node of a network, for a better localization of themselves.

OEX AUTONOMOUS UNDERWATER VEHICLES. The Centre operates two Ocean Explorer AUVs capable of carrying a variety of payloads, including side scan sonar, towed sonar arrays, and physical oceanography sensors (Fig. 3).



Fig. 3 - Ocean Explorer by University of Florida

MARITIME SITUATIONAL AWARENESS. The scope of this project is to increase the ability of NATO to detect threats at sea by extracting useful information from a variety of data sources using automated techniques and advanced algorithms. The goal is towards an automated intelligent classification of the behaviours.

MDF. The Maritime Data Fuser (MDF) is a program to take data from multiple sources and merge them into an accurate picture of the marine environment. MDF is used in maritime security to track vessels and identify abnormal behavior (Fig. 4). Currently, the sources for MDF are from coastal and navigational radar and the Automatic Identification System (AIS). CMRE is exploring the use of other data sources, such as spaced-based AIS, high frequency radar, satellite-based SAR, and mobile sensors. The center develop sensors and have realized synthetic aperture sonar; typically commercial platforms are bought and then are modified. Actually tendency is for increase the on board intelligence of the robot to minimize the underwater data transmission. Intelligent classification of targets is included in this paradigm. Multi parameter optimization is under study to increase the sampling efficiency of a group of glider. They communicate when emerged, to re-planning the sampling mission on the news exchanged between them, as example taking in account the density of the maritime traffic or to perform a finer sampling.

As measure of the activities there are about 40 publications each year and about 20 sea trials and/or engineering tests.

Other activities

The center has coordination and proposal function for the standards definitions between European countries of NATO to ensure that machinery made in different countries are interoperable. Moreover he center offers a service for Extremely high pressure testing facilities, Material properties & tension/fatigue, testing facilities and Oceanographic instrument (CTD) calibration facilities.

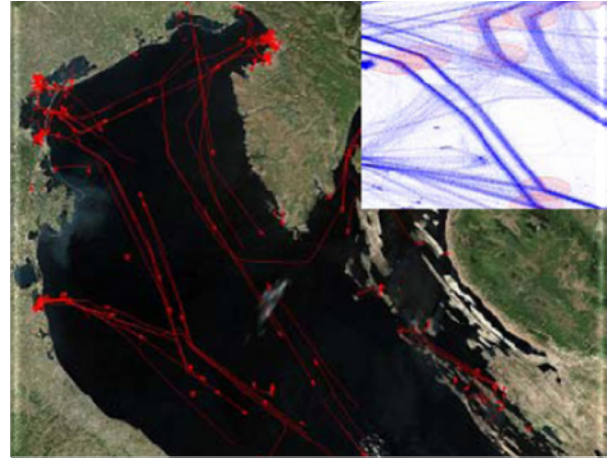

Fig. 4 - Tracking of Maritime traffic



Fig. 5 - One of the two ships available at the center

Facilities

- It operates two research vessels (Fig. 5) that enable science and technology solutions to be explored and exploited at sea. The largest of these vessels, the NRV Alliance, is a global class vessel that is acoustically extremely quiet. It was developed with consideration to one central goal: the reduction of ship-radiated noise for scientific use.
- A Bluefin AUV (that have 3000 km experience - Fig. 6), seven SLOCUM glider (Fig. 8), just operative in the Mediterranean sea, two ocean explores, by University of Florida. All of them have been customized to develop scientific researches.
- There are also six “Folaga” (Fig. 7), two marine surface robot vehicle, working in cooperation with AUV vehicle. Some sensors, like Synthetic aperture sonar, are developed inside.
- Modeling & Simulation (M&S) is one of the Critical Technologies with particular value for the NATO Nations in term of Defense, Homeland Security and Economy; in fact Simulation allows to use computer models to mime behaviors of existing real world systems, or hypothetical future systems and to carry out experiments in a virtual environment to improve understanding, performance as well as to develop new concepts and to test new technologies. There is also a very big harbor simulator (Fig. 9) to simulate threats and attacks (Fig. 10).



Fig. 6 - Bluefin AUV

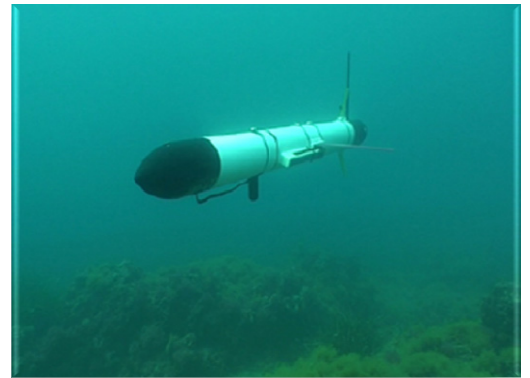

Fig. 7 - The Folaga AUV



Fig. 8 - Slocum gliders



Fig. 9 - Advanced simulator of harbour



Fig. 10 - Advanced simulator of harbour

Main results (papers and realizations)

Alvarez, A.

Redesigning the Slocum glider for torpedo tube launching. In: *IEEE Journal of Oceanic Engineering*, 2010, vol. 35 (4) pp 984-991.

Alvarez, A., Gassie, L.

Autonomous networks in the maritime environment. In: *Defence Global*, November 2008, p. 44-45.

Alvarez, A., Mourre, B.

Oceanographic field estimates from remote sensing and glider fleets

In: *Journal of Atmospheric and Oceanic Technology*, vol. 29, issue 11 (November 2012), p. 1657-1662.

Alvarez, A., Mourre, B.

Optimum sampling designs for a glider-mooring observing network.

In: *Journal of Atmospheric and Oceanic Technology*, vol. 29, issue 4 (April 2012), p. 601-612.

Alvarez, A.

Redesigning the SLOCUM glider for torpedo tube launching. In: *IEEE Journal of Oceanic Engineering*, Vol. 35, No. 5, October 2010, pp. 984-991. CMRE Reprint NURC-PR-2012-002

Alvarez, A.

Volumetric distribution of oceanographic fields estimated from remote sensing and in situ observations from autonomous underwater vehicles of opportunity. In: *IEEE Journal of Oceanic Engineering*, Vol. 36, No. 1, January 2011, pp. 13-25. CMRE Reprint NURC-PR-2012-003.

Been, R., Hughes, D.T., Vermeij, A.

Heterogeneous underwater networks for ASW technology and techniques. UDT Europe, Undersea Defence Technology Europe, Glasgow, United Kingdom, 10-12 June 2008. CMRE Reprint NURC-PR-2008-001.

Berdaguer, X., Alvarez, A., Coiras, E., Conforto Sesto, J.R.

Vehículos autónomos submarinos nuevos actores en las operaciones navales. In: *Revista General de Marina*, volume 256, June 2009, p. 839-849

Braca, P., Marano, S., Matta, V.

Single-transmission distributed detection via order statistic. In: *IEEE Transactions on Signal Processing*, 2012, Vol. 60, pp. 2042-2048.

Curtin, T.B., Djapic, V.

Sea mine countermeasures from the bottom up. In: *Defence Global*, November 2009, p. 48-49.

De Paulis, R., Prati, C.M., Rocca, F., **Biagini, S.**, Carmisciano, C., Gasparoni, F., **Pinto, M., Tesei, A.**, System and method for detecting and measuring phenomena relating to altimetric variations in the seafloor United States Patent Application US20120113752. Rome, ENI S.p.A. Application number: 13/264581 Filing date: 14 Apr 2010.

De Paulis, R., Prati, C.M., Rocca, F., **Biagini, S.**, Carmisciano, C., Gasparoni, F., **Pinto, M., Tesei, A.**, System and method for detecting and measuring phenomena relating to altimetric variations in the seafloor World International Patent WO/2010/119338A1. Rome, ENI S.p.A. 2010.

Disma, C.

Proud Manta 2012 nuovi scenari per le operazioni ASW. In: *Rivista Italiana di Difesa*, no. 5, May 2012, p. 26-33.

Djapic, V., Nad, D.

Collaborative autonomous vehicle use in mine countermeasures. In: *Sea Technology*, 2010, Vol. 51 (11), pp. 19-23.

Djapic, V., Dula, N.

Using collaborative autonomous vehicles in mine countermeasures. OCEANS 2010, Sidney, Australia, 24-27 May 2010.

Doisy, Y., Deruaz, L., **Been, R.**

Interference suppression of subarray adaptive beamforming in presence of sensor dispersions. In: *IEEE Transactions on Signal Processing*, 2010, Vol. 58 (8), pp. 4195-4212.

- Dosso, S.E., Wilmut, M.J., **Nielsen, P.L.**
Bayesian source tracking via focalization and marginalization in an uncertain Mediterranean Sea environment. In: *Journal of the Acoustical Society of America*, 2010, Vol. 128 (1), pp. 66-74.
- Ehlers, F.**, Dofge, D., Chitre, M., **Potter, J.R.**
Distributed mobile sensor networks for hazardous applications
Cairo, Hindawi, 2012. In: Special issue of the *International Journal of Distributed Sensor Networks*.
- Ehlers, F.**
A multi-agent concept for multistatic sonar
In: Proceedings of Informatik 2010, Lecture Notes in Informatics, vol. P-176, p. 824-830.
- Ehlers, F., Fox, W.F.J.,** Maiwald, D., Ulmke, M., Wood, G.
Advances in signal processing for maritime applications. *Eurasip Journal on Advances in Signal Processing*, 2010, art. no. 512767.
- Grasso, R., Coccocioni, N., Rixen, M., Trees, C.C., Baldacci, A.**
A generic decision support architecture for maritime operations. In: *International Journal of Intelligent Defence Support Systems*, 2010, Vol. 3, pp.281-304.
- Grasso, R., Cococcioni, M., Rixen, M., Baldacci, A.**
A decision support architecture for maritime operations exploiting multiple METOC centres and uncertainty. In: *International Journal of Strategic Decision Sciences*, 2011, Vol. 2 (1), pp. 1-27.
- Groen, J., Coiras, E., Williams, D.P.**
Effective false alarm rejection for sea mine classification. In: *Sea Technology*, March 2011, Vol. 52, Issue 3, p.27.
- Hamilton, M.J., Kemna, S., Hughes, D.**
Antisubmarine warfare applications for autonomous underwater vehicles: The GLINT09 sea trial results. In: *Journal of Field Robotics*, 2010, Vol. 27 (6), pp. 876-889.
- Hamilton, M., Kemna, S., Baralli, F., Hughes, D., LePage, K.D., Mazzi, M., Vermeij, A.**
Real-time signal processing and an autonomous adaptive behaviour for ASW on-board an AUV: challenges, developments, and sea trial results. UDT Europe-Hamburg 2010.
- Harrison, C.H.**
The relation between the waveguide invariant, multipath impulse response and ray cycles. In: *Journal of the Acoustical Society of America*, 2011, Vol. 129, pp. 2863-2877.
- Holland, C.W., Nielsen, P.L., Dettmer, J., Dosso, S.**
Resolving meso-scale seabed variability using reflection measurements from an autonomous underwater vehicle. In: *Journal of the Acoustical Society of America*, Vol 131, 2912, 1066-1078.
- Hughes, D.T., Baralli, F., Kemna, S., Hamilton, M., Vermeij, A.**
Collaborative multistatic ASW using AUVs demonstrating necessary technologies.
Originally published in: MAST 2009, Stockholm, Sweden, 21-23 October 2009.
CMRE Reprint NURC-PR-2009-007.
- Hughes, D., Osse, L.A.**
Making AUVs more autonomous for ASW. In: *Defence Global*, February 2010, p. 52-53.
- Incze, Michael L.
Lightweight Autonomous Underwater Vehicles (AUVs) performing coastal survey operations in REP 10A
In: *Ocean Dynamics*, DOI 10.1007/s10236-011-0446-z, June 2011.
- Kemna, S., Hamilton, M., Hughes, D.T., LePage, Kevin D.**
Adaptive autonomous underwater vehicles for littoral surveillance : the GLINT10 field trial results. In: *Intelligent Service Robotics*, Vol. 4, No. 4, pp. 245-258, 2011, NURC-PR-2012-008.
- Kemna, S., Hamilton, M., LePage, K.D., Hughes, D.** Adaptive behaviours for autonomous underwater vehicles in anti-submarine warfare. European Conference on Artificial Intelligence. Lisbon, 16-20 August 2010.

Kemna, S., Hamilton, M., Hughes, D.T.,

Antisubmarine warfare applications for autonomous underwater vehicles: the GLINT09 field trial results. In: *Journal of Field Robotics*, Vol. 27, No. 6, pp. 890-902, 2010. CMRE Reprint NURC-PR-2012-009.

Kemna, S., Hughes, D.T., Hamilton, M., LePage, K., Vermeij, A., Baralli, F.

A broadside behaviour for an autonomous underwater vehicle. International Conference on Robotics and Automation, Anchorage, Alaska, 2010

LePage, K.D.

An SNR maximization behaviour for autonomous AUV control. 10th European Conference on Underwater Acoustics (ECUA) 2010, Istanbul, 4-9 July 2010.

LePage, K.D., Hamilton, M., Kemna, S.

Autonomous underwater vehicles for active multistatic undersea surveillance. 4th International Conference on Underwater Acoustic Measurements: Technologies and Results (UAM 2011), Kos, Greece.

Maguer, A., Dymond, R., Guerrini, P., Troiano, L., Grandi, V., Figoli, A., Olivero, C., Sapienza, A., Fioravanti, S., Potter, J.R.

Receiving and transmitting acoustic systems for AUV/gliders. CMRE Reprint NURC-PR-2009-004

Monda, N.

AutoLARS (Autonomous Launch and Recovery System).

Genova, Università degli Studi di Genova. Facoltà di Ingegneria.

Master's thesis, University of Genova, 2011, performed by the author as a Visiting Research Scientist stage at NURC.

Myers, V., Williams, D.

A POMDP for multiview target classification with an autonomous underwater vehicle. MTS/IEEE OCEANS 2010, Seattle, WA, 20-23 September 2010.

Nielsen, P.L., Harrison, C.H., Holland, C.

Local bottom characterization using an autonomous underwater vehicle (AUV). International Symposium on Underwater Reverberation and Clutter ISURC'08. Lerici, 9-12 September 2008.

Osler, J., Stoner, R., Cecchi, D.

Gliders debut at Proud Manta 11 as data-gathering platforms. In: *Sea Technology*, November 2011, vol. 52, no. 11, pp. 37-41.

Osse, J., Maguer, A., Chitre, M., DeBoni, M., Guerrini, P., Potter, J. Autonomous launch and recovery system (AutoLARS) for AUVs. 10th European Conference on Underwater Acoustics (ECUA) 2010, Istanbul, 4-9 July 2010.

Pastore, T.J., Djapic, V. Improving autonomy and control of autonomous surface vehicles in port protection and mine countermeasure scenarios. In: *Journal of Field Robotics*, 2010, 27 (6), pp. 903-914.

Pastore, T.J., Patrikalakis, N. Laser scanners for autonomous surface vessels in harbour protection: analysis and experimental results. Waterside Security Conference (WSS), 2010 International Carrara, Italy 3-5 November 2010.

Pastore, T.J., Kessel, R.T.

Unmanned surface vessels for surface and subsurface threats in harbours: background and practical lessons. UDT Europe, Undersea Defence Technology Europe, Cannes, 9-11 June 2009. CMRE Reprint NURC-PR-2009-015.

Siderius, M., Song, H., Gerstoft, P., Hodgkiss, W.S., Hursky, P., **Harrison, C.**

Adaptive passive fathometer processing. In: *Journal of the Acoustical Society of America*, 2010, Vol. 127 (4), pp. 2193-2200.

Signell, R.P., **Chiggiato, J., Horstmann, J.**, Doyle, J.D., Pullen, J., Askari, F. High-resolution mapping of Bora winds in the northern Adriatic Sea using synthetic aperture radar. In: *Journal of Geophysical Research C: Oceans*, 2010, Vol. 115 (4), art. no. C04020.

Sletner, P.A., Biagini, S. Guerrini, P., Gasparoni, F., Carmisciano C., Locritani, M.

SAS multipass interferometry for monitoring seabed deformation using a high-frequency imaging sonar.

In: Proceedings of IEEE Oceans 2011, Spain, June 2011.

Strode, C., Cecchi, D., Yip, H.

The effectiveness of a system-of-systems for countering asymmetric maritime threats in ports and harbours. In: Proceedings of the 1st International Conference and Exhibition on Waterside Security (WSS 2008), Technical University of Denmark, Copenhagen, Denmark, 25-28 August 2008. CMRE Reprint NURC-PR-2008-013.

Trees, C., Sanjuan Calzado, V., Besiktepe, S.

Improving optics-physics-biology coupling in ocean ecosystem models. In: *Eos*, 2010, Vol. 91 (16), p. 144.

Vignali, M.A.

I fantasmi del mare. In: MARE (Marine Advanced Research of Environment), no. 19, August-October 2010, p. 48-67.

Williams, D.P.

AUV-enabled adaptive underwater surveying for optimal data collection. In: *Intelligent Service Robotics*, Vol. 5, No. 1, pp. 33-54, 2012. CMRE Reprint NURC-PR-2012-007.

Williams, D.P., Couillard, M.

Efficient dense sonar surveys with an autonomous underwater vehicle. 11th European Conference on Underwater Acoustics, Edinburgh, UK, 2-6 July 2012.

Williams, D.

Label-alteration to improve underwater mine classification. In: *IEEE Geoscience and Remote Sensing Letters*, 2011, Vol. 8 (3), pp. 488-492.

Williams, D.P.

On adaptive underwater object detection. In: Proceedings of the IEEE/RSJ International 2011 Conference on Intelligent Robots and Systems (IROS), San Francisco, California, September 25-30, 2011. CMRE Reprint NURC-PR-2012-006.

References

Captain Nemo goes online. In: *The Economist* (Technology Quarterly supplement), vol. 406, no. 8826, March 9th 2013, p. 19-20.

Clearing the way

UUVs evolve to meet front-line MCM requirements

In: *Jane's International Defence Review*, March 2008 p. 42-48.

Hollosi, C.

NATO deploys gliders for ASW exercise

In: *Jane's International Defence Review*, vol. 44, March 2011, p. 22.

Lundquist, E.

AUV competition in Europe challenges students with real-world conditions

In: *Naval Engineers Journal*, no. 124-1, March 2012, p. 49-55.

Lundquist, E.,

Removing man from minefield. In: *Seapower*, April 2012, p. 40-43.

Lundquist, E.

Sure you can create an underwater robot, but can you teach it to do tricks in La Spezia harbor?

In: *CRUSER News*, issue 3, March 2012, p. 2.

Lundquist, E.

Unmanned underwater vehicles is bigger better, or smaller smarter? In: *Naval Forces*, v. 23, no. 3(2012), p. 41-49.

Osse, L.A.

Advancements in using autonomous underwater vehicles as platform for ASW: a networked system for undersea surveillance. In: *Defence Global*, August 2009, p. 76-77.

Peruzzi, L.

Proud Manta ASW exercise adds new focus to operations. In: *Jane's International Defence Review*, vol. 44, April 2011, p. 5.

Scott, R.

From small fry to big fish? In: *Unmanned Vehicles*, v. 14, p. 23-25. Slough, Shephard 2009.

Scott, R.

Going it alone sensors and autonomy the key to subsea "systems of systems". In: *Jane's International Defence Review*, vol. 44, March 2011, p. 32-33.

The Foundation “Italian Institute of Technologies” (IIT)

IIT: Summary Table	
Institute	IIT Via Morego, 30, Genoa, Italy
Year of foundation	2003
Reference person	Prof. Roberto Cingolani, Darwin Caldwell
Website	http://www.iit.it/
Scientific Areas	Man-machine interface Artificial intelligence Humanoid Robotics Sensors and perception Biorobotics Mechatronics
Robotic Applications	Medical robotics Assistive Robotics Entertainment Robotics
Scientific Expertise	Mechanical Design Mechanical Construction Materials Technologies Systems Engineering and Electronic Design Informatics Signal Processing Control theory Neuroscience
Team size Senior researchers	Variable. Around 80-90 young researchers about 10-20 Research directors. Most of them are Ordinary Academic Professors

Introduction

Italian Institute of Technologies, located in the Genoa outskirts, is a public foundation, able to behave with some characteristics of public bodies and with most of the flexibility of private enterprises that has been launched in 2003 and since few years reached its full operation capability.

It is shared among three main souls: the Nanotechnologies, the Neurosciences and the Robotics. This description and the relevant notes are of course aimed mainly at this last part.

It is important to stress that after its foundation IIT already differentiated its goals so that currently the full number of scientific platforms are:

- Robotics
- Neurosciences
- Energy
- Smart Materials
- EHS (Environment, Health, Safety)
- D4 (Drug Discovery, Development and Diagnostics)
- Computation.

Anyway a very detailed description of the official activities of the Institute is reported in its website www.iit.it one of the most powerful communication tools available within the national research centers.

Policy of the body

IIT has the ambition to promote the most innovative research attracting young and promising scientists from the entire world, allowing them to develop the most advanced and ambitious research ideas and trying to realize those surprising dreams by means of a well supported and organized team job.

In terms of exchange of these ideas with the territory the policy of IIT is based on the capability to stimulate cooperation with other RTOs and Academies inside the national territory and outside. Several cooperation centers have been opened in many Italian centers, especially in the North. A current list of these centers are in the following reported:

- Space Human Robotics (Polytechnic of Turin)
- Nanoscience and Technology Center (in cooperation with Polytechnic of Milan),
- Genomic Sciences Center (in cooperation with University of Milan)
- Neurosciences and Cognitive Systems (University of Trento)
- Brain Center for motor and social cognition (University of Parma)
- Center for Life NanoScience (University of Rome “Sapienza” on medical sciences)
- Center for Nanotechnology Innovation (Univ. of Pisa)
- Center for MicroBioRobotics (Scuola Superiore S. Anna – Pisa)
- Center for Advanced biomaterials (University of Naples “Federico II”)
- Center for Biomolecular Nanotechnologies (University of Lecce).

On the website it is possible to find out much information about the objectives, the research programs and the centered results.

The true heart of the IIT is anyway in Via Morego 30, and in this site there also most of the IIT laboratories of Robotics in Italy.

What is the basic of the IIT operation is a sort of unwritten epitome “we want to innovate”. Young researchers coming from the entire world are tested to understand if they have new ideas, ambitions strong enough to risk new paths and abilities to achieve their results. If so, they are accepted in the research center, organized in research teams with other young researchers and under the coordination of few senior, international level, scientists and equipped with high level instrumental laboratories. Then they are free to work and try their ideas.

This approach lead to highly innovative results also if sometimes bring the research quite far by the original objectives; as an example, a new approach to the energy generation has been successful presented by IIT at the PNI (Premio Nazionale per l'Innovazione) contest in Verona (organized by "il Sole 24 Ore"). It received a substantial success and the initiative has been transformed in a new spin-off. Nevertheless, the specific core of the proposed innovation has not much to share with robotics: it is the design and realization of a new microturbine machine. It makes use of metal microfusion technology and is able to bring significant savings in energy in many industrial and even domestic processes. A typical example could be in the exploitation of energy waste of industrial processes and in the powering of sensing networks.

Apart from the occasional deviations by its institutional aims, IIT has defined a general method to transfer expertise towards industry. The national, but also international venture capital is a field where IIT is well placed and that widely use to let go its young researchers looking for industrial opportunities.

IIT is also a great antenna of worldwide upcoming progresses. The capability of this institute to capture many young researchers from every part of the world, offer the unique opportunity to sense what is under development much before than the progresses become clear through the classical method of publication and of Congress participations.

Darwin Caldwell, one of the directors of Robotics Institute is for instance convinced that Korea is currently much more advanced than usually in the field of humanoid science and that they are probably very close to have a product ready to find a market niche.

Under the point of view of the main current focus of robotics research IIT is well positioned in the areas of Rehabilitation, of variable stiffness actuators and man-robot soft interaction.

With reference to the exploitation of special and variable stiffness actuators it is to mention the Hyq Hydraulically Actuated Quadruped robot, under development (See Fig. 11 and Fig. 12).

In competition with some of the most advanced worldwide realizations, especially for military applications.

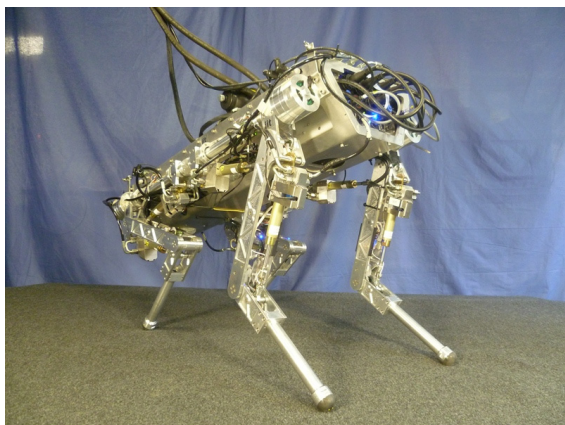

Fig. 11 - Hyq robot - front vie

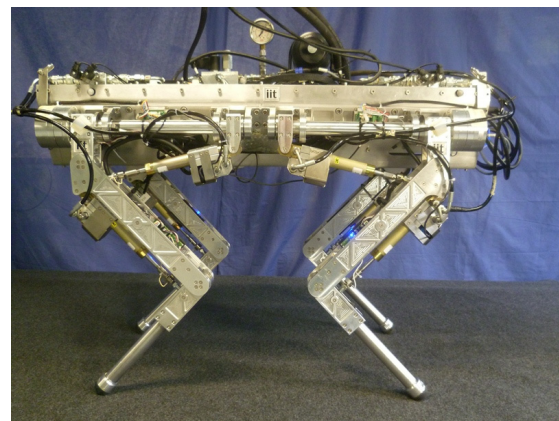

Fig. 12 - Hyq - side view

Turin area

The integration between Industry, Academy and Education

Some notes on the area features

Also in robotics the area of Turin is characterized by the dominant presence of FIAT and by its satellite industries. COMAU is the most prominent example, but PRIMA is another one and many other smaller industries follow this big player.

At the same time education is also affected, driven by the different needs of the large industry. The Academic institutions are lead to satisfy the industry requests setting up courses and researches that can bring the most relevant advantage to the skill and competitiveness of the local industry.

This general line, which can be seen also at lower education grades, can be viewed as a positive effect, but has the secondary consequence to determine a structure slightly different in the education organization with respect to other Italian large areas of robotics research like Naples, Pisa, Rome and Milan.

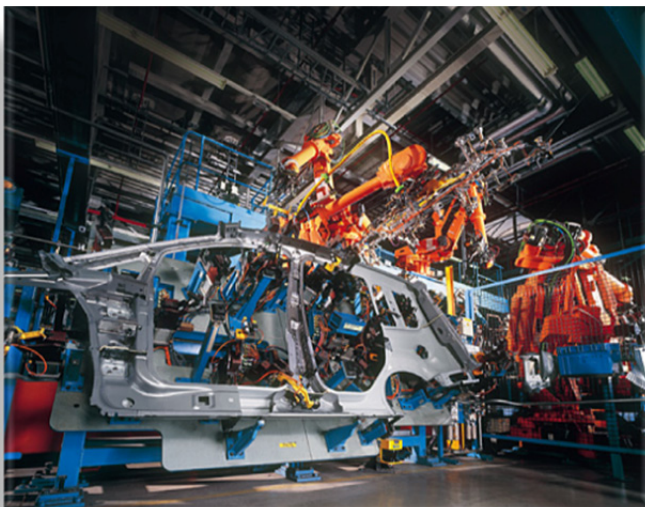

Fig. 13 - Soldering line of COMAU



Fig. 14 - Zaphyro laser robot of PRIMA

DAUIN, DIMEAS - Polytechnic of Turin

DAUIN, DIMEAS: Summary Table	
Institute	Polytechnic of Turin Corso Duca degli Abruzzi, Turin, Italy
Year of foundation	1906
Reference person	Prof. G. Quaglia, Prof. M. Velardocchia, Prof. Moriero, Prof. B. Bona, Prof. M. Sorli
Website	http://areweb.polito.it/ricerca/LabRob/
Scientific Areas	Robotics, Automation
Robotic Applications	Space Robotics, Autonomous Vehicles
Scientific Expertise	
Team size Senior researchers	Not available > 6

Introduction

Polytechnic of Turin is one of the leading academic level schools but is not focused, as in the case of many other academies, around a strong and highly specialized teaching and research robotics group. On the contrary, there exist many groups working on boundary topics and able to give highly professionals contributes on realizations that are typically market centered.

In the following we report some of the more important groups and departments that work around the robotics and automation thematic.

- Department of Automatics and Informatics – DAUIN Robotics Research Group – Mechatronics and mobile systems – ref. Prof. Basilio Bona.
- Department of Automatics and Informatics – DAUIN Software Engineering group – Automatics, Automation and Operational Research – ref. Prof. Moriero.
- Department of mechanical aerospace Engineering – DMEAS – Prof. Sorli (Department director), reffs. Prof. Velardocchia, Prof. Quaglia.
- Department of mechanical aerospace Engineering – DMEAS – Prof. Ferraresi Carlo, pneumatic actuators and mechanics applied to machines.

The cooperation among the various groups is usually very good, but the different application fields create rare occasions of common jobs so that they are usually looking for solutions that can increase the synergy and the opportunities of information exchange. Under this point of view many researchers of Polytechnic encouraged to think and develop solutions for research integration at a national level.

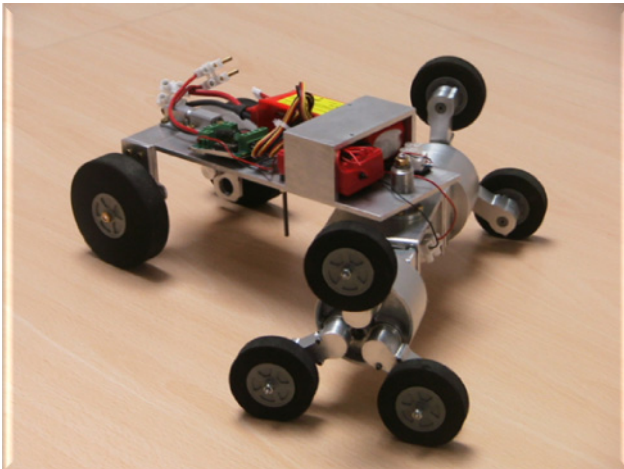

Fig. 15 - Advanced Mobile Mini robot

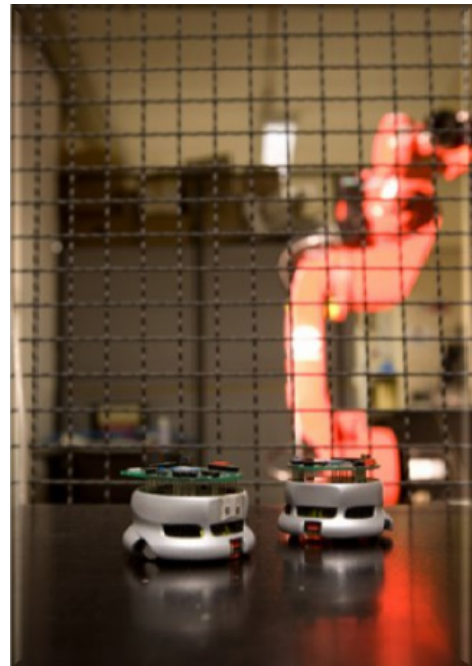

Fig. 16 - Some platforms used to the RRG laboratory of Prof. B. Bona at Polytechnic of Turin



Fig. 17 - The Robotic Research Group (RRG) from Polytechnic of Turin coordinates the three-years (2008-2010) project “MACP4Log - Mobile Autonomous and Cooperating robotic Platforms for supervision and monitoring of large Logistic surfaces”, aimed at the study

Research

Without pretending to be exhaustive in listing the many research actions of Polytechnic, it is to point out that the interests of this Academy ranges from the automation of road vehicles to the study of movement of classical mobile indoor vehicles (see Fig. 15 and Fig. 16), to the coordinated motion of groups of mobile systems (Fig. 17).

Other historical activities are in the field of the study of actuation systems based on the fluidic control. Also logics have been studied together with the joining of logics and actuation systems.

Recently, a joint activity for space robotics has been launched by DMEAS in cooperation with IIT. It aims at carrying out studies on Artificial Intelligence, Robotics (with special reference to humanoids studies), artificial cognitive systems and microactuators among the others in space environment. For the realisation of such ambitious program a dedicated institute has been realised in the Polytechnic areas: the Center for Space Human Robotics. Collaboration agreements with the major robotics industries like COMAU and PRIMA are also active since many years.

Main results (papers and realizations of reference people)

Abrate, B. Bona, M. Indri, S. Rosa and F. Tibaldi "Multirobot Localization in Highly Symmetrical Environments", Journal of Intelligent and Robotic Systems, doi: 10.1007/s10846-012-9790-6 In press.

A. Ferraro, M. Indri, I. Lazzero, "Dynamic update of a virtual cell for programming and safe monitoring of an industrial robot", 10th IFAC Symposium on Robot Control, Dubrovnik, Croatia, 5-7 September 2012. pp. 895-900.

L. Carlone, B. Bona, "On Registration of Uncertain Three-Dimensional Vectors with Application to Robotics", 18th IFAC World Congress, 2011.

J. Du, L. Carlone, M. Kaouk Ng, B. Bona, M. Indri, "A Comparative Study on Active SLAM and Autonomous Exploration with Particle Filters", 2011 IEEE/ASME International Conference on Advanced Intelligent Mechatronics (AIM 2011), Budapest, Hungary, pp. 916-923, 2011.

F. Abrate, M. Indri, I. Lazzero, A. Bottero, "Efficient solutions for programming and safe monitoring of an industrial robot via a virtual cell," 2011 IEEE/ASME International Conference on Advanced Intelligent Mechatronics (AIM 2011), Budapest, Hungary, pp. 434-439, 2011.

L. Carlone, R. Aragues, J. A. Castellanos, and B. Bona, "A Linear Approximation for Graph-based Simultaneous Localization and Mapping", in Proceedings of Robotics: Science and Systems (RSS), 2011.

L. Carlone, M. Kaouk Ng, J. Du, B. Bona, M. Indri, "Simultaneous Localization and Mapping Using Rao-Blackwellized Particle Filters in Multi Robot Systems", Journal of Intelligent and Robotic Systems, vol. 63, 283-307, 2011.

G.C. Calafiore, F. Abrate, "Distributed Linear Estimation over Sensor Networks", International Journal of Control, vol. 82(5), pp. 868-882. - ISSN 0020-7179, 2009

B. Bona, M. Indri, N. Smaldone, "Rapid Prototyping of a Model-Based Control with Friction Compensation for a Direct-Drive Robot", IEEE/ASME Transactions on Mechatronics, vol.11, n. 5, pp. 576-584, 2006.

M. Indri, A. Tornambè, "Control of a Series of Carts in the Case of Nonsmooth Unilateral Impacts", Applied Mathematics Letters, vol. 19, n. 6, pp. 541-546, 2006.

B. Bona, M. Indri, N. Smaldone, "Friction Identification and Model-based Digital Control of a Direct-Drive Manipulator", in Current Trends in Nonlinear Systems and Control (editors: L. Menini, L. Zaccarian, C. Abdallah), Birkhauser, Boston, pp. 231-251, 2006.

B. Bona, M. Indri, N. Smaldone, "Architectures for Rapid Prototyping of Model-Based Robot Controllers", in Advances in Control of Articulated and Mobile Robots (editors: B. Siciliano, A. De Luca, C. Melchiorri, G. Casalino), Springer, pp. 101-123, 2004.

M. Indri, "Impact Modelling and Control of Robotic Links", in RAMSETE - Articulated and Mobile Robotics for Services and Technologies (editors: S. Nicosia, B. Siciliano, A. Bicchi, P. Valigi), Springer, Lecture Notes in Control and Information Sciences Series, vol. 270, pp. 155-179, 2001 (ISBN 3-540-42090-8).

G. Calafiore, M. Indri, B. Bona, "Robot Dynamic Calibration: Optimal Excitation Trajectories and Experimental Parameter Estimation", Journal of Robotic Systems, vol. 18, n. 2, pp. 55-98, 2001.

North-eastern Italy

The research pole of the most industrialized area of Italy

The North-East is the most industrially developed area of Italy and it encloses, as in the representation we gave in the beginning of this report, Lombardia, Veneto, Emilia Romagna, Trentino Alto Adige and Friuli.

In this first presentation of our job we had not the opportunity to explore all the excellence centers of Lombardia, but it is to point out that the groups working in this area are much more than those coming from the traditional control science. Many excellent groups, for instance, arrived to robotics starting by side technologies, especially in the sensing area, like artificial vision. This is for instance the situation of Parma University and Pavia University. The trip along the Italian robotics groups will continue in the next months and the centers not yet visited will supply further important information and suggestions.

In any case what has been learned by the visits, especially in the Milan Polytechnic is that the effort of transferring the researches results towards the local industries and to the final users is present in every operator and, in most of the cases, in any single research leader.

Perhaps the most attractive application area is currently the human centered robotics, with special reference to the possibilities opened for medical robotics. The impression we received is anyway a big effort to join the resources and the capabilities of different research groups to achieve the availability of larger facilities, more advanced test instrumentation and platforms commonality.

This is not a general trend in Italy. In other areas the competition among the different research lines can become stronger thus preventing this opportunity. In our view what is under construction, especially at Polytechnic of Milan is the most promising way to keep high the capability of our State to compete at international level.

Airlab, Merlin, Nearlab, Cartcas - Polytechnic of Milan

Airlab, Merlin, NearLab, Cartcas: Summary Table	
Institute	Polytechnic of Milan Milan, Italy
Year of foundation	1863
Reference person	Prof. Andrea Bonarini et al.
Website	http://www.polimi.it/ http://airlab.elet.polimi.it/index.php/AIRWiki http://www.cartcas.polimi.it/ http://www.nearlab.polimi.it/ http://merlin.elet.polimi.it/
Scientific Areas	Artificial intelligence Machine Learning Autonomous robots Sensors and perception Biorobotics Mechatronics
Robotic Applications	Entertainment Robotics Medical Robotics Assistive Robotics Industrial Robotics
Scientific Expertise	
Team size	100
Senior researchers/professors	50

Polytechnic of Milan represent one of the most significant examples of what should be the evolution of national resources in robotics.

Historically, Robotics was born in Polytechnic in the decade 1970-1980 owing to the initiative of two top level researchers: Prof. Marco Somalvico, unfortunately disappeared in 2002, that founded in 1971 the “Artificial Intelligence and Robotics” project and that was one of the first Italian representative in IARP international organization together with Dr. C. Mancini (ENEA) and Dr. S. Bevilacqua (ENEA); the other “father” was Prof. Alberto Rovetta, that in 1980 opened the course in robot mechanics.

Starting by these origins, robotics, or part of its large range of studies, have been introduced in many of the Polytechnic Departments: among these we can mention DEI (Department of Electronics and Informatics), Department of Mechanics, Department of Bioengineering and others. Inside these Departments many groups took places working on the themes of Artificial Intelligence (AirLab, the first founded in 1971), Merlin Group for industrial Innovation, Near Lab (NeuroEngineering and Medical Robotics), CartCas (more oriented to robots for radiotherapies and imaging) and others with a total number of professor and researchers around 50 people leading a similar number of PhD and doctorates employed in research activities.

According to the information delivered by Polytechnic, the whole amount of people working and studying in various robotics courses, application and projects is therefore around the impressive figure of almost 500 people active in robotics.

All these group are in close cooperation and the realization of a new joint laboratory, aimed at the opportunity to realize an infrastructure not only aimed at hosting large and interdisciplinary projects, but also to get ready a possibility to attract SMEs and LEs for a more direct impact on the local (mainly) or even international industrial area.

Polytechnic of Milan carried out a number of initiatives to spread the knowledge and understanding of Robotics and its potential: since two years it was opened a joined web site “robotics.polimi.it” that is a focal point of all the activities of all the groups active inside Polytechnic.

This website is well maintained and most of information that are reported inside this book can also be found on the Polytechnic site.

AirLab

The main interests of AirLab are in the following listed:

- **Artificial Intelligence:** Knowledge representation and management, expert systems, uncertainty management, intelligent agents, game theory,...
- **Machine Learning:** Reinforcement Learning, Neural Network, Bayesian Networks, Genetic Algorithms, Learning Classifier Systems. Applications: videogames, control systems, affective computing, e-science, signal interpretation
- **Autonomous robots:** Sensor data interpretation (including computer vision), control architectures, cognitive robotics, bio-inspired robotics, SLAM, benchmarking, entertainment robots, edutainment robots

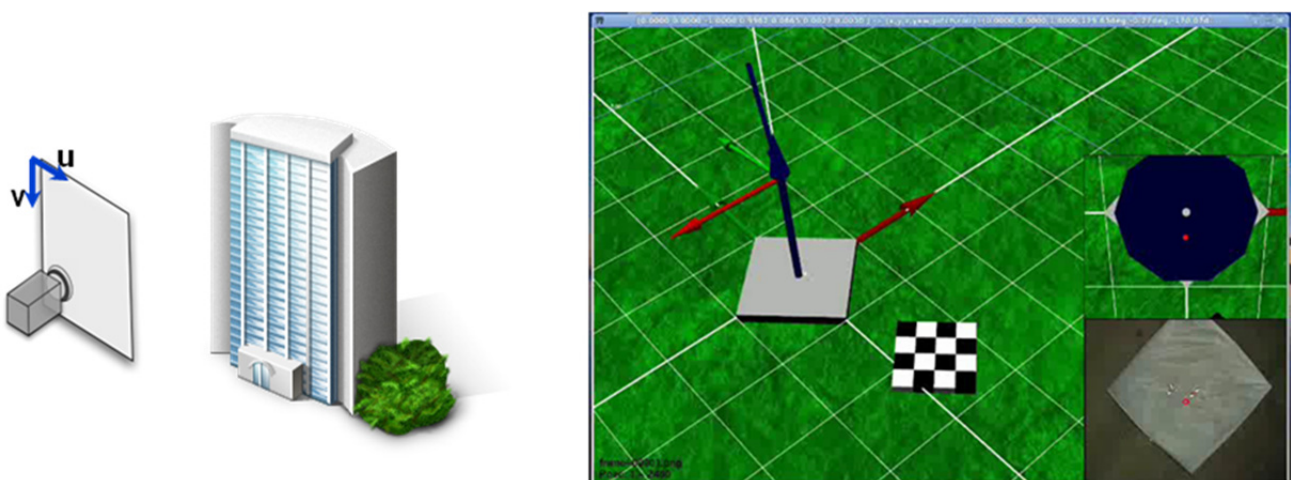
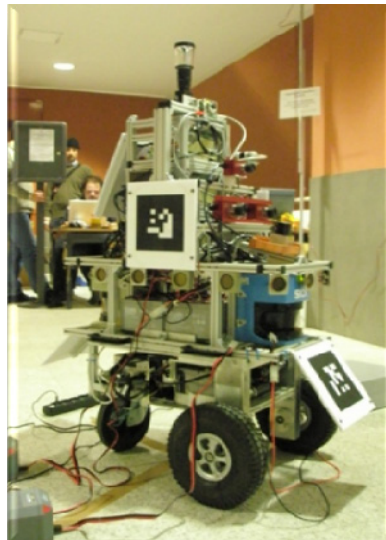

Fig. 18 - SLAM for UAVs

The practical results of the research of the group are quite a large number in the following a quick review could mention the realization of advanced SLAM systems for UAV vehicles.



Fig. 19 - Rawseeds project



In this area POLIMI was Prime Contractor in **FP6 RAWSEEDS Project** Funded SSA to collect and publish a benchmarking toolkit for (S)LAM research:

- Use of an extensive sensing
- LRFs (2D) and sonars
- B/W + Color cameras
- Omnidirectional camera
- GPS/D-GPS Odometry & IMU

Sensors are synchronized and acquired at maximum frequency to allow a proper sensor fusion.

A significant effort has been historically devoted to the support

of injured and disabled people. The most recent development was the realization of an intelligent wheelchair (Fig. 20) not only able to carry out simple and preplanned actions like in the previous experiences, but also to choose among different possible action plans depending on what seems to be more convenient after achieving an awareness of the environment.

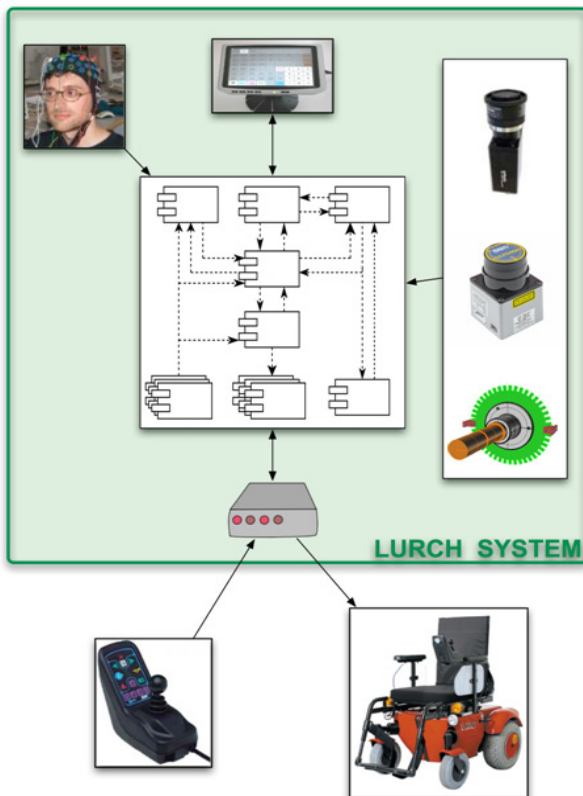

Fig. 21 - Architecture of LURCH system

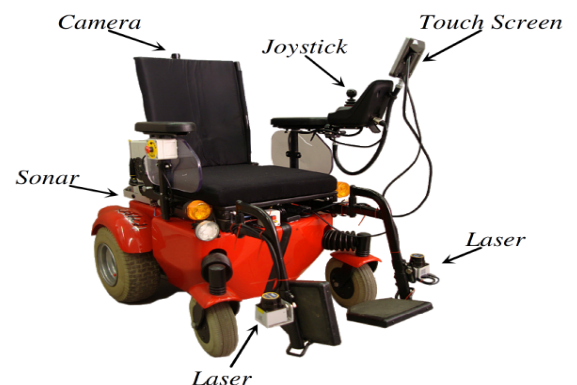

Fig. 20 - Wheelchair realised within LURCH

Merlin Group

Merlin Group, active since early 90's, is the direct heir of the activity ignited by prof. Rovetta and was located inside the Mechanical Department, now joined with DEI.

Their core competencies are in Mechatronics, Industrial Robotics and Motion Control.

Probably their most important project was ROSETTA, the **RO**bot control for **Skilled ExecuTion** of **T**asks in natural interaction with humans; based on **A**utonomy, cumulative knowledge and learning.

Rosetta is a Large Scale Integrating project of FP7, with a total budget beyond 10 Million of Euro that was started in March 2009 and had the participation of the top of industrial robotics in Europe, namely ABB AB (coordinator) from Sweden, ABB AG (Germany), Fraunhofer IPA (Germany), DYNAmore GmbH (Germany), K.U. Leuven (Belgium), Ludwig-Maximilians-Universität Munich (Germany), Lund University (Sweden) and Polytechnic of Milan.

The philosophy of Rosetta project was to change the operation of handling robots in order to allow and easy and safe interaction with the human worker.

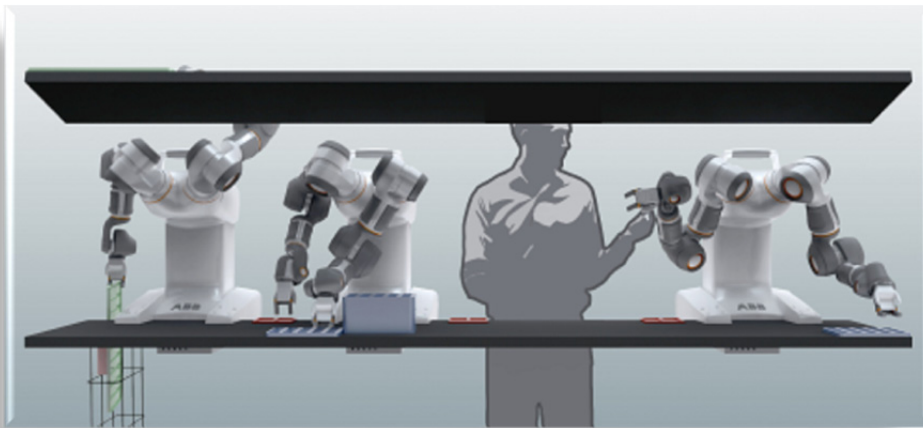

Fig. 22 - ROSETTA. Cooperative work with robots

Four overall objectives are set forth in the project:

- Enable robots to be used in complex tasks with **high flexibility** and robustness
- **Ease the deployment effort** to allow fast production changeover from product A to product B
- Create an **easy-to-use programming system** to access the ROSETTA robot functionality without the need for highly skilled robot programmers
- Develop new sensing, control and decision making methods for a **safe physical human-robot interaction** in a real-world production scenario.

An example of how these objectives have been introduced is in the reaction control design, based on the minimization of some injury risk through sensor measurement and founded on the Danger Field concept that can be calculated following the two approaches of Static danger field (Fig. 23) or the Kinetostatic danger field (Fig. 24) takes into account a situation much more complicated where the relative speed of the human and the robots are considered with a priority always given to the man movements.

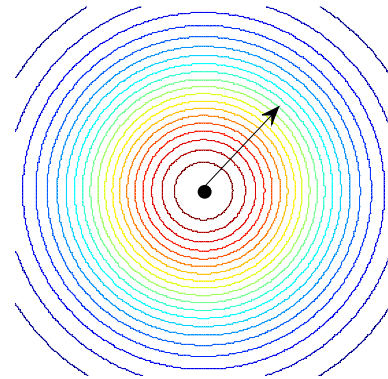

Fig. 23 - A decreasing function w.r.t. the distance from the “source of danger”

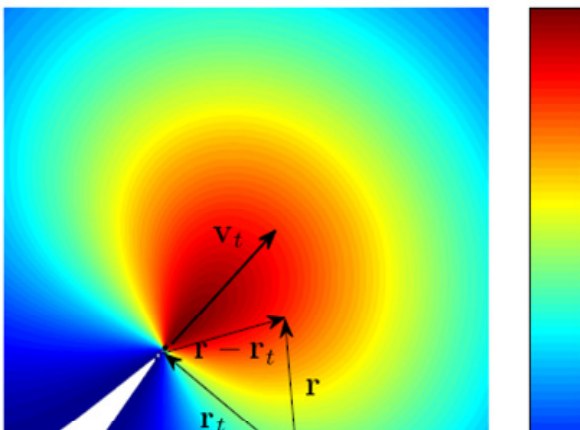

Fig. 24 - Takes into account a velocity vector of the source of danger as well

Nearlab

It is a laboratory of young researchers, working in neuroengineering and medical robotics with about 16 high skilled people that focused their effort especially in the field of assisted surgery and

robotics in neuroengineering. Most recent and significant projects in surgery area, all funded in FP7 programs, have been:

- Robocast from 2008 to 2010 . DG INFSO 2.1
- Active from 2011 to 2015 DG INFSO 2.1
- EuroSurge from 2011 to 2013 DG INFSO 2.1



NearLab
 Bioengineering Department
 Politecnico di Milano
www.biomed.polimi.it/nearlab

In the specific field of Neurorobotics:

- Mundus DG INFSO 7.2
- RealNet DG INFSO 8.8



The expertise they gained in the field is one of the most prominent in Italy. In Active, for instance, they work to the problem of interaction among the surgeon and the robot (Fig. 25), compensating the movement of the patient, managing the remote operation introducing virtual constraints and the positioning phase of the robot (the surgeon remains always in full control of the procedure).

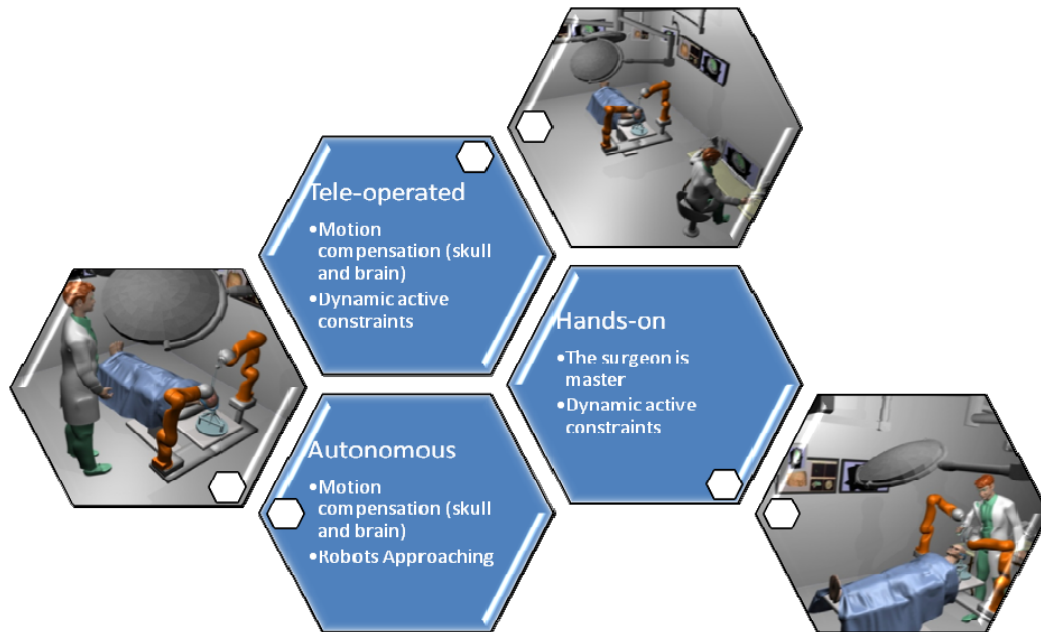

Fig. 25 - Active FP7 project

Mundus is instead a project devoted to the analysis of how the human brain manages the information coming from the surrounding reality.

Mundus (Fig. 26) is a project devoted to introduce the possibility to control external actuators analyzing the human brain processing of external stimuli.

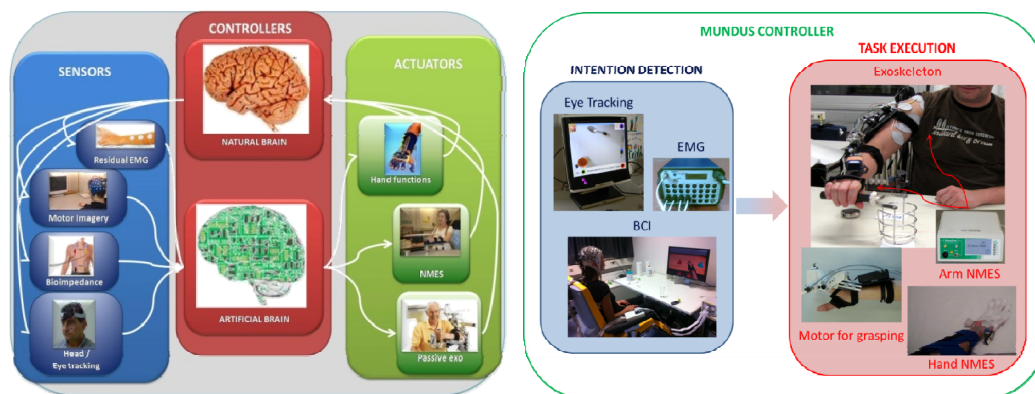

Fig. 26 - Mundus focal points

Cartcas group

This research group is quite close to the Nearlab in terms of application target. The difference is more in the cultural original birth of the groups than in the application aspects: neurological studies in the case of Nearlab, whereas a more significant attention to the problems of image processing and data fusion is the drive of the Cartcas group.

CartCas is perhaps the Polytechnic Robotics research group that is more close to the Verona's Altair lab and in fact the two groups are often working in close cooperation and other times in competition.

- 17 people (November 2012) including faculties (3), post-docs (3), Ph.D. students (8) and research; fellows (3) working on the development of technologies and methods for computer assisted surgical; planning, navigation and target localization, with application in high-precision radiation oncology, orthopedic surgery, plastic and reconstructive surgery;
- Specific focus is given to translation research, which is empowered by long-lasting, strategic collaboration agreements with national and international clinical institutions, with strong vocation for applied clinical research.

The most important research of CartCas is probably in the cooperation with CNAO, the National Center for Oncological Adrontherapy (Fig. 27). The cooperation is active since several years and the laboratory developed a number of advanced technologies, especially for in-room image guidance.



Fig. 27 - CartCas laboratory at CNAO

During the cooperation with CNAO a number of technologies have been under the focus of the CartCas group: among these we can mention:

- robotics imaging of the patient during the intervention (Fig. 28);
- study and design of several engineering aspects like optics, actuation, illumination, mechanics and computational architecture;
- robotics instruments for mini-invasive surgery (Fig. 29).

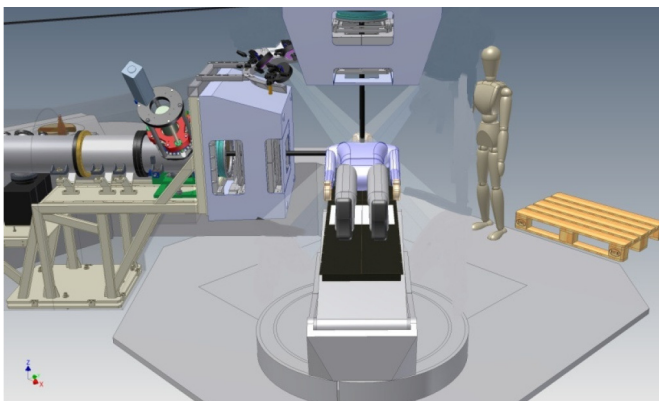

Fig. 28 - Robotics imaging in Surgical Room



Fig. 29 - Endoscopic robot for surgery

A special attention was also devoted to the problem of localization of the surgical tools outside and inside the patient (approaching and operation) without the need to radiate the patient with an excess of X-ray doses. This technology has been called “image-based localization technology”.

Main results (papers and realizations of reference people)



Bonarini A., Lazaric A., Restelli M. (2007) Reinforcement learning in complex environments through multiple adaptive partitions. In R. Basili and M. T. Paziienza (Eds.) AI*IA 2007: Artificial Intelligence and Human-oriented Computing. Lecture Notes on Artificial Intelligence 4733, Springer Verlag, Berlin, D, 531-542.

Blatt R., Bonarini A., Calabrò E., Della Torre M., Matteucci M., Pastorino U. (2007) Fuzzy K-NN Lung Cancer Identification by an Electronic Nose. In “Applications of Fuzzy Sets Theory”, LNAI4578, 261—268, Springer-Verlag, Berlin, isbn 978-3-540-73399-7.

Bonarini A., Caccia C., Lazaric A., Restelli M. (2008) Batch Reinforcement Learning for Controlling a Mobile Wheeled Pendulum Robot in Max Bramer (Ed.) IFIP International Federation for Information Processing, Artificial Intelligence in Theory and Practice II, Volume 276, Springer-Verlag, Berlin, D. 151—160.



Blatt R., Bonarini A., Matteucci M. (2010) Pattern Classification Techniques for Lung Cancer Diagnosis by an Electronic Nose. In Bichindaritz I., Sachin V., Jain A., Jain L.C. (Eds.), Computational Intelligence in Healthcare 4: Advanced Methodologies, Studies in Computational Intelligence, Volume 306, Springer-Verlag, Berlin, D. DOI: 10.1007/978-3-642-14464-6_18. pp. 397-423.

Bonarini A., (2012) Cooperative Robotics In Robocup Soccer Is Not Just Playing a Game. In Kernbach S. (Ed.) Handbook of Collective Robotics. CRC press, Singapore.



B. Lacevic, P. Rocco, A.M. Zanchettin “Safety assessment and control of robotic manipulators using danger field” IEEE Transactions on Robotics, in press.



L. Bascetta, G. Ferretti, G. Magnani, P. Rocco, “Walk-through programming for robotic manipulators based on admittance control”, Robotica, available online, DOI: 10.1017/S0263574713000404

G. Ferretti and F. Casella. Editorial - Special issue on object-oriented modelling and simulation. Mathematical and Computer Modelling of Dynamical Systems. Vol. 16, No. 3, June 2010, pp. 161-164.



F. Donida, F. Casella and G. Ferretti. Model order reduction for object-oriented models: a control systems perspective. Mathematical and Computer Modelling of Dynamical Systems. Vol. 16, No. 3, June 2010, pp. 269-284.

F. Donida, G. Ferretti, S.M. Savaresi and M. Tanelli. Object-oriented modelling and simulation of a motorcycle. Mathematical and Computer Modelling of Dynamical Systems. Vol. 14, No. 2, April 2008, pp. 79–100.



G. Ferretti, G. Magnani, P. Rocco, L. Viganò
“Modelling and Simulation of a Gripper with DYMOLA”
Mathematical and Computer Modelling of Dynamical Systems, Vol. 12, pp. 89-102, 2006.

G. Ferretti, G. Magnani, P. Rocco “Single and Multi-State Integral Friction Models”, IEEE Transactions on Automatic Control, Vol. 49, December 2004, pp. 2292-2297.

G. Ferretti, G. Magnani, P. Rocco, “Virtual Prototyping of Mechatronic Systems”, Annual Reviews in Control, Vol. 28, 2004, pp. 193-206.

Patete P, Iacono M, Spadea MF, Trecate G, Vergnaghi D, Mainardi L, Baroni G A multi-tissue mass-spring model for computer assisted breast surgery Med Eng Phys, in Press, 2012



Silvatti A, Sarro K, Cerveri P, Baroni G, Barros R A 3D kinematic analysis of breathing patterns in competitive swimmers J Sport Sci, 2012

Tagaste B, Riboldi M, Spadea MF, Bellante S, Baroni G, Cambria R, Garibaldi C, Ciocca M, Catalano G, Alterio D, Orecchia R Comparison Between Infrared Optical and Stereoscopic X-ray Technologies for Patient Setup in Image Guided Stereotactic Radiotherapy Int J Radiat Oncol Biol Phys, 2012

G. Ferretti, G. Magnani, P. Rocco

“Impedance Control for Elastic Joints Industrial Manipulators”,
IEEE Transactions on Robotics and Automation, Vol. 20, June 2004, pp. 488-498.

A.M. Zanchettin, L. Bascetta, P. Rocco “Acceptability of robotic manipulators in shared working environments through human-like redundancy resolution”
Applied Ergonomics, available online, DOI:10.1016/j.apergo.2013.03.028

B. Lacevic, P. Rocco

“Safety-Oriented Path Planning for Articulated Robots”
Robotica, available online, DOI: 10.1017/S0263574713000143

L. Bascetta, P. Rocco, A.M. Zanchettin, G. Magnani

“Velocity control of a washing machine: a mechatronic approach”
Mechatronics, Vol. 22, No. 6, pp. 778-787, September 2012

A.M. Zanchettin, P. Rocco. “A general user-oriented framework for holonomic redundancy resolution in robotic manipulators using task augmentation”. IEEE Transactions on Robotics , Vol. 28, No. 2, pp. 514-521, April 2012.

B. Lacevic, P. Rocco. “Closed form solution to controller design for human-robot interaction”. ASME Journal of Dynamic Systems, Measurement, and Control, Vol. 133, No. 2, March 2011.



De Momi E, Caborni C, Cardinale F, Castana L, Casaceli G, Cossu M, Antiga L, Ferrigno G. 2013. Automatic trajectory planner for StereoElectroEncephaloGraphy procedures: a retrospective study. IEEE Transaction on Biomedical Engineering, Special Issue on Surgical Robotics. 60(4): 986 - 993. [More] [Bibtex]



De Lorenzo D, De Momi E, Conti L, Votta E, Riva M, Fava E, Bello L, Ferrigno G. 2013. Intraoperative forces and moments analysis on patient head clamp during awake brain surgery. Medical & Biological Engineering & Computing. 51(3): 331-341. [More] [Online version] [Bibtex]

Cardinale F, Cossu M, Castana L, Fuschillo D, Casaceli G, Schiariti M, Miserocchi A, Moscato A, Caborni C, Arnulfo G and others. 2013. StereoElectroEncephaloGraphy: Surgical Methodology, Safety and Stereotactic Application Accuracy in Five Hundred Procedures. J. Neurosurgery. 72(3): 353 - 366. [More] [Bibtex]

De Lorenzo D, Koseki Y, De Momi E, Chinzei K, Okamura A. 2013. Coaxial needle insertion assistant with enhanced force feedback.. IEEE Transactions on Biomedical Engineering. 60(2): 379-389. [More] [Online version] [Bibtex]

Haidegger T, Barreto M, Gonçalves P, Habib M, Ragavan V, Li H, Vaccarella A, Perrone R, Prestes E. 2013. Applied ontologies and standards for service robots. Robotics and Autonomous Systems. [More] [Bibtex]

Vaccarella A, De Momi E, Enquobahrie A, Ferrigno G. 2013. Unscented Kalman Filter Based Sensor Fusion for Robust Optical and Electromagnetic Tracking in Surgical Navigation. Instrumentation and Measurement, IEEE Transactions on. 62(7): 2067-2081. [More] [Online version] [Bibtex]

University of Bologna: Summary Table	
Institute	Dipartimento di Ingegneria dell'Energia Elettrica e dell'Informazione «Guglielmo Marconi» Viale Risorgimento, 2 - Bologna
Year of foundation	
Reference person	Prof. Claudio Melchiorri claudio.melchiorri@unibo.it
Website	http://www-lar.deis.unibo.it/
Scientific Areas	Non linear control, Fuzzy logic control, Manipulator, Modeling and simulation of dynamical systems
Robotic Applications	Industrial robotics, space and medicine
Scientific Expertise	Fuzzy logic, Control Theory
Team size	25
Senior researchers	9

Introduction

The robotics activities of the University of Bologna are centered on the laboratory of automation and robotics (LAR-DEIS) of the department of electronics, computer science and systems. Other activities are also developed in the Alma Space robotics lab (see, for instance Fig. 30 (<http://spaceroboticslab.altervista.org/spaceroboticslab/Homepage.html>) and Group of Robotics and Articular Biomechanic (GRAB <http://grab.diem.unibo.it/>).

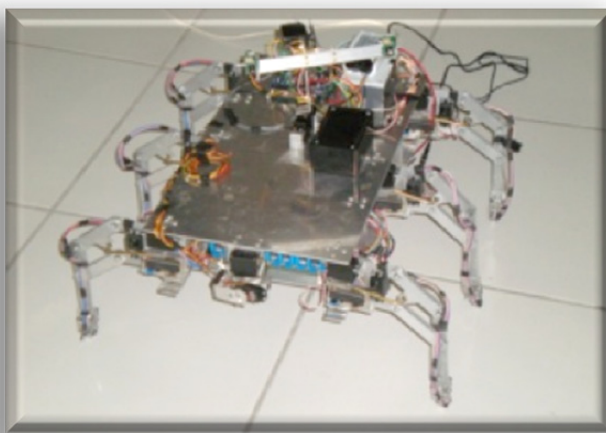

Fig. 30 - Exapod rover developed at the ALMA laboratories

The LAR operates in strict cooperation with the Center for Complex Automated Systems (CASYS); Its main goal is to explore fundamental theory issues in the advanced design for control of nonlinear complex dynamical systems, with special attention to internal-model-based control and adaptation, fault-tolerant and self-reconfiguring control systems, advanced control for autonomous guidance, advanced automotive control, adaptation of control strategies to evolving control goals and needs.

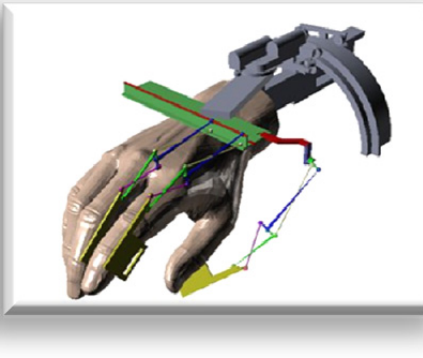

Fig. 31 - Hand active orthosis for the rehabilitation of motor functions at the GRAP

The main research topics are in the frame of real time control systems and robotics.

Regarding the robotics, the research activities are developed in the fields of robotic manipulation (with the development of articulated hands, sensors, control – Fig. 31), control systems for the remote handling, of haptic systems and mobile robotics. Customer applications of this research are both in the industrial sector, which in space robotics or with application to medicine.

With regard to the control systems, the research develops according to topics regarding the laws of nonlinear control, passive control, modeling and control of port-Hamiltonian systems, the development of hw / sw systems for real-time control. Moreover study issues related to motion control in the field of automatic machines are carried out.

Educational

The University of Bologna offers course in automated control and industrial robotics. PhD thesis are available on arguments as development of control algorithms for industrial robots at LAR (Comau, PUMA 560), use of force sensors / torque and tactile manipulation robotics, mouse with force feedback based on linear engine and so on.

Research

The principal disciplines of research are described below.

Haptic device and mechatronics

Design and experimental evaluation of a three-fingered robotic gripper for underwater applications. The gripper has innovative features with respect to other devices known in the literature, concerning in particular the workspace, the kinematic capabilities, and the sensory equipment.

Robust Nonlinear Control and FDI - FTC Fault Detection and Isolation - Fault Tolerant Control

This topic is regarding the control of a redundant robotic manipulator with variable stiffness actuation. The problem of controlling simultaneously the end-effector position and stiffness exploiting the robot redundancy for the optimization of the robot configuration is considered, and the relation between the manipulator redundancy and the selection of both the joint and end-effector stiffness is studied. The controller is configured as a cascade system that allows the decoupling of the actuators dynamics from the arm dynamics and the consequent reduction of the order of the manipulator dynamic model. Only the actuator and joint positions are needed by the controller, introducing in this way a significant simplification with respect to previously proposed state feedback techniques. The effectiveness of the proposed approach is verified by simulations of a 3-DOF planar manipulator.

Advanced Robotics

Unmanned flying vehicle (UAV) is studied starting from the well known quadrotor model; some features has been introduced in order to create an over-actuated quadrotor able to fly performing maneuvers that are typically not feasible for UAVs. An inverse dynamics control scheme is proposed to control the modified flying vehicle, with particular attention to the asset control. The stability and versatility of the solution has been proven by means of numerical simulations.

Collaboration

Starting from 1994 the LAR-DEIS, University of Bologna, is a member of the academic nodes ICMS-NOE. Its main objective is to pool together and enhance the human and material resources of leading research and academic institutions as well as all related industries.

In the first part of the '90, the LAR-DEIS was part of ERNET, the European Robotics Network. The key point of this initiative relayed on the proposal of research projects made by each laboratory, and on the interest by post-doc researchers or doctorate students to cooperate with laboratories of other countries within ERNET.

At the moment LAR-DEIS is part of EURON, that is a network of excellence in robotics, aimed at coordination and promotion of robotics research in Europe and sponsored by the European Commission through the Future and Emerging Technologies Program under DG-INFOSOC.

An educational cooperation was issued by the Minister of Education of the People's Republic of China, Zhou Ji and the former Minister of Education, University and Research of the Republic of Italy, Letizia Moratti in Beijing, China on July 4th, 2005. This cooperation was reconfirmed by the Minister Fabio Mussi and the Chinese Vice Minister of Education Zhao Qiping on September 18th, 2006, within the "Joint Italian-Chinese Campus".

Funded projects

The Laboratory of Automation and Robotics (LAR) of the University of Bologna is involved in some important research programs of national and international interest that are involving the most important research centers in Italy and in Europe.

Principal project are SHERPA and DEXMART.

SHERPA

The goal of SHERPA was to develop a mixed ground and aerial robotic platform to support search and rescue activities in a real-world hostile environment, like the alpine scenario that is specifically targeted in the project. What makes the project potentially very rich from a scientific viewpoint is the heterogeneity and the capabilities to be owned by the different actors of the SHERPA system: the human rescuer is the "busy genius", working in team with the ground vehicle, as the "intelligent donkey", and with the aerial platforms, i.e. the "trained wasps" and "patrolling hawks". Indeed, the research activity focuses on how the "busy genius" and the "SHERPA animals" interact and collaborate with each other, with their own features and capabilities, toward the achievement of a common goal.

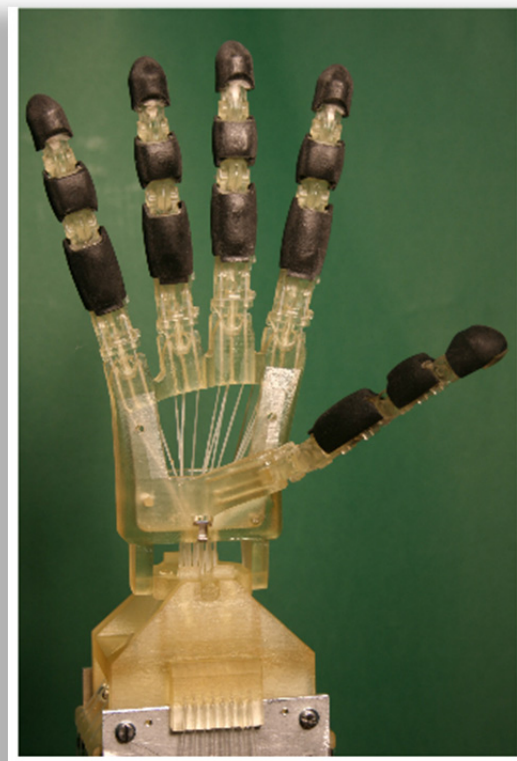

Fig. 32 - Human hand developed in the DEXMART project

“DEXMART” is an acronym and stands for “DEXterous and autonomous dual-arm/hand robotic manipulation with sMART sensory-motor skills: A bridge from natural to artificial cognition”. DEXMART is a large-scale integrating project which is funded under the European Community’s 7th Framework Programme. The project started on 1 February, 2008.

DEXMART has the ambition to fill the gap between the use of robots in industrial environments and the use of future robots in everyday human and unstructured environments, contributing to reinforce European competitiveness in all those domains of personal and service robotics where dexterous and autonomous dual-hand manipulation capabilities are required.

Main achievements within DEXMART are integrated design of the hand (see Fig. 32), the wrist and the actuation system, development of innovative sensors based on optoelectronic components and compliant structure, development of the twisted string actuation system, intensive study on soft covers for mimicking human skin.

Other activities

Other activities in the robotic field are going on, using all the equipments that the laboratory provides us. We have provided a theoretical and practical approach to the problematic of remote control using the industrial robot PUMA 562 by Unimation, and a study of new control algorithms for the industrial robot SMART-3 S by COMAU.

In the motion control system field, the activities are concerning with the analysis of some industrial drives. At LAR, you can find the following ones:

- the Digital Servo Controller GMC Turbo System Module 1394 Motion Control by Allen-Bradley;
- the Master Drive Motion Control by SIEMENS.

Another really important activity is about the development of rapid prototyping board for the easy development of control algorithms for example in the motion control systems. This project brought to the realization of a computer board called FastProt (Fast Prototyping), with a user friendly interface and a C based control algorithm development environment.

Facilities

- Industrial Manipulator Comau SMART-3 S, with the C3G9000 Control Unit.
- UNIMATE Puma 562 MARK III, VAL II
- University of Bologna Robotic Hand, (UBH), Version I and Version II.
- ActivMedia Robotics PIONEER 2 DX.

Publications

Bacocco, R., Borghesan, G., & Melchiorri, C. (2012). Experimental evaluation of two control schemes for cooperative teleoperation. Paper presented at the *World Automation Congress Proceedings*,

Bemfica, J. R., Melchiorri, C., Moriello, L., Palli, G., Scarcia, U., & Vassura, G. (2013). Mechatronic design of a three-fingered gripper for underwater applications. Paper presented at the *IFAC Proceedings Volumes (IFAC-PapersOnline)*, 307-312.

Biagiotti, L., & Melchiorri, C. (2012). FIR filters for online trajectory planning with time- and frequency-domain specifications. *Control Engineering Practice*, 20(12), 1385-1399.

Biagiotti, L., & Melchiorri, C. (2011). Input shaping via B-spline filters for 3-D trajectory planning. Paper presented at the *IEEE International Conference on Intelligent Robots and Systems*, 3899-3904.

Borghesan, G., & Melchiorri, C. (2011). A computational model for frictional effects applied to dexterous hands with soft pads. Paper presented at the *IFAC Proceedings Volumes (IFAC-PapersOnline)*, 18(PART 1) 1072-1077.

Falconi, R., & Melchiorri, C. (2012). A graph-based algorithm for robotic MANETs coordination in disaster areas. Paper presented at the *IFAC Proceedings Volumes (IFAC-PapersOnline)*, 325-330.

- Falconi, R., & Melchiorri, C. (2012). Dynamic model and control of an over-actuated quadrotor UAV. Paper presented at the *IFAC Proceedings Volumes (IFAC-PapersOnline)*, 192-197.
- Ficuciello, F., Palli, G., Melchiorri, C., & Siciliano, B. (2011). Experimental evaluation of postural synergies during reach to grasp with the UB hand IV. Paper presented at the *IEEE International Conference on Intelligent Robots and Systems*, 1775-1780.
- Ficuciello, F., Palli, G., Melchiorri, C., & Siciliano, B. (2012). Planning and control during reach to grasp using the three predominant UB hand IV postural synergies. Paper presented at the Proceedings - *IEEE International Conference on Robotics and Automation*, 2255-2260.
- Grandi, R., Falconi, R., & Melchiorri, C. (2012). A navigation strategy for multi-robot systems based on particle swarm optimization techniques. Paper presented at the *IFAC Proceedings Volumes (IFAC-PapersOnline)*, 331-336.
- Grandi, R., Falconi, R., & Melchiorri, C. (2011). UniBot remote laboratory: A scalable web-based set-up for education and experimental activities in robotics. Paper presented at the *IFAC Proceedings Volumes (IFAC-PapersOnline)*, , 18(PART 1) 8521-8526.
- Marconi, L., Melchiorri, C., Beetz, M., Pangercic, D., Siegart, R., Leutenegger, S., . . . Tomatis, N. (2012). The SHERPA project: Smart collaboration between humans and ground-aerial robots for improving rescuing activities in alpine environments. Paper presented at the 2012 *IEEE International Symposium on Safety, Security, and Rescue Robotics, SRR 2012*,
- Melchiorri, C., Palli, G., Berselli, G., & Vassura, G. (2013). On the development of the UB-hand IV: An overview of design solutions and enabling technologies. *IEEE Robotics and Automation Magazine*,
- Palli, G., Borghesan, G., & Melchiorri, C. (2012). Modeling, identification, and control of tendon-based actuation systems. *IEEE Transactions on Robotics*, 28(2), 277-290.
- Palli, G., & Melchiorri, C. (2011). Interaction force control of robots with variable stiffness actuation. Paper presented at the *IFAC Proceedings Volumes (IFAC-PapersOnline)*, , 18(PART 1) 13504-13509.
- Palli, G., & Melchiorri, C. (2012). On the control of redundant robots with variable stiffness actuation. Paper presented at the *IEEE International Conference on Intelligent Robots and Systems*, 5077-5082.
- Palli, G., Scarcia, U., Melchiorri, C., & Vassura, G. (2012). Development of robotic hands: The UB hand evolution. Paper presented at the *IEEE International Conference on Intelligent Robots and Systems*, 5456-5457.
- Peerdeman, B., Fabrizi, U., Palli, G., Melchiorri, C., Stramigioli, S., & Misra, S. (2012). Development of prosthesis grasp control systems on a robotic testbed. Paper presented at the Proceedings of the *IEEE RAS and EMBS International Conference on Biomedical Robotics and Biomechanics*, 1110-1115.
- Sanz, P. J., Ridao, P., Oliver, G., Casalino, G., Insaurralde, C., Silvestre, C., . . . Turetta, A. (2012). TRIDENT: Recent improvements about autonomous underwater intervention missions. Paper presented at the *IFAC Proceedings Volumes (IFAC-PapersOnline)*, , 3(PART 1) 355-360.
- Battagliere, M. L., Candini, G. P., Piattoni, J., Paolini, E., & Piergentili, F. (2010). Testing an innovative boom for microsatellite attitude stabilization: An educational experiment on sounding rocket reus-7. Paper presented at the 61st *International Astronautical Congress 2010, IAC 2010*, , 3 2316-2324.
- Candinia, G. P., Piergentilib, F., & Santoni, F. (2012). Miniaturized attitude control system for nanosatellites. *Acta Astronautica*, 81, 325-334.
- Florentine, C. A. M., Battagliere, M. L., Casonato, G., Covello, F., Duca, E., Porfilio, M., . . . Fleeter, R. (2011). Introducing MINAS ITHIL: An italian micro and nano-satellites mission to the moon. Paper presented at the 62nd *International Astronautical Congress 2011, IAC 2011*, , 5 4176-4190.
- Sancisi, N., & Parenti-Castelli, V. (2010). A 1-dof parallel spherical wrist for the modelling of the knee passive motion. *Mechanism and Machine Theory*, 45(4), 658-665.
- Sancisi, N., & Parenti-Castelli, V. (2011). A novel 3D parallel mechanism for the passive motion simulation of the patella-femur-tibia complex. *Meccanica*, 46(1), 207-220.
- Sancisi, N., & Parenti-Castelli, V. (2011). A sequentially-defined stiffness model of the knee. *Mechanism and Machine Theory*, 46(12), 1920-1928.
- Sancisi, N., & Parenti-Castelli, V. (2011). Strip-driven devices for the spatial motion guidance of human joints. Paper presented at the Proceedings of the Annual International Conference of the *IEEE Engineering in Medicine and Biology Society, EMBS*, 632-635.

Altair - University of Verona

Altair: Summary Table	
Institute	University of Verona, Department of Informatics
Year of foundation	Not Available
Reference person	Prof. Paolo Fiorini, Marta Capiluppi
Website	http://metropolis.sci.univr.it/altair/ , https://www.facebook.com/altairlab
Scientific Areas	Artificial Intelligence, Medical Robotics
Robotic Applications	Medicine
Scientific Expertise	
Team size	20
Senior researchers	2

Introduction

University of Verona concentrates its robotics expertise around the group of Prof. Paolo Fiorini, in the Informatics department.

The philosophy of the Robotics Laboratory (Altair) is in the strong integration among the job of all the participants and in a deep integration of the laboratory itself in the European Robotics Network.

The Laboratory members are engaged in a number of specific research lines that match together to create different application cases. One of the most significant project/application case refers to the surgery applications with especial reference to cryogenic cancer treatments.

This research is supported by an on-going (2012) European project named Eurosurge (Fig. 33 and 34). The participation of Verona University in this project is based on two lines with two research groups.



Fig. 33 - Layout of the surgical area in EUROSURGE project

A first group, working on image processing and recognition, works to extract position information from the standard TAC analysis and remap them with ultrasonic sensors (ecographic). This action is a very critical one because the position of the internal organs during the surgical operation is not the same as it was during the TAC analysis. Therefore the

software is in charge to match the organs as they appear in the real time echography and in the TAC reference image to offer to the surgeon the best possible scene of the surgical intervention area avoiding to perform a large number of TAC during the penetration of the cryogenic tool inside the body to be sure that the damage of cryofluid is limited to the cancer area.

A second group is working on the control design of a manipulation system able to do a self-positioning with respect to the patient. This second research group is also in charge of a sensing integration to allow the localization of the cryogenic actuator all around the surgery room with sub-millimetric precision. This is carried out by means of a multiple range sensors, whereas a data fusion software allow a seamless passage by the room localization to the intrabody localization (ultrasounding driven) by exploiting all the previous information and allowing a real-time control of the cryogenic tool without the need for additional and dangerous TACs.

Actions implemented to achieve EuRoSurge objective

- 1 - Identification of research laboratories and companies involved in CRAS.
- 2 - Development of a map of the current activities in CRAS in Europe.
- 3 - Identification of the main integration elements of Cognitive Surgical Robotics for: definition of common language and conceptual structure; definition of modular architecture; definition of performance evaluation and compatibility tests; detection of potential non-technical roadblocks.
- 4 - Proposing actions leading to the integration of European efforts in CRAS, resulting in: an action plan to extend these activities on a longer/broader range; a recommendation/proposal to the EC for a supported activity; an action plan for a community-driven open-source activity.

What will the developed framework do?

- 1 - Simplify communication among the surgical, engineering and manufacturing communities;
- 2 - Facilitate the integration of results of research and development into complex systems;
- 3 - Simplify technology transfer from research to products;
- 4 - Identify research synergies and thus maximize the impact of funding.



Map of robotics and cognitive science laboratories doing research in surgery

Fig. 34 - Eurosurge project actions

Apart from the Medical and Surgery applications the Altair Laboratory is strongly involved in co-operation to support the spread of technology concept within the high and middle schools in Verona area.

Cycles of seminars and short courses calibrated for the students of these classes are target of yearly activities carried out both by the students and by the postdoc researchers.

To support and reinforce this peculiar

activity a European project has been carried out within 2012 (Fig. 34) to develop a software architecture suitable to offer procedures to play and/or program robots at different skill levels. Everything is designed following plug and play concepts so that a child of middle school can efficiently program a robot movement (mobile platform or arm) using a number of predefined configurations for achieve its actuation and a university student can apply its dynamics understanding to modify the “open” architecture and adapt the parameters to optimize the behaviour of the system.

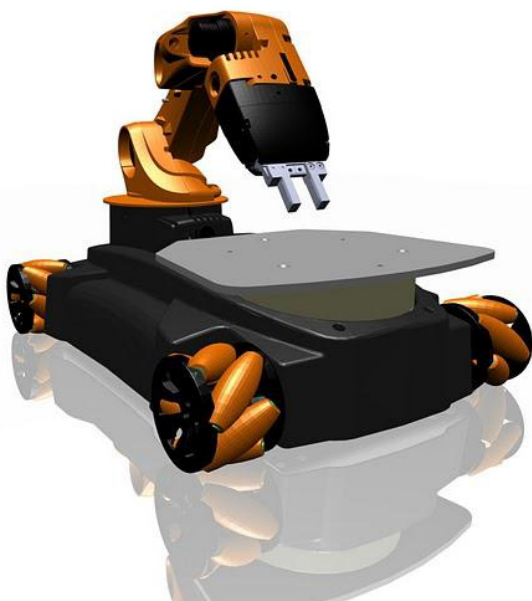

Fig. 35 - The EduFill-Experiment bridges this gap between frontier research and education, by introducing state of the art concepts and solutions in mobile manipulation into the classroom

The system is also conceived to allow an easy interface among environments like firms and academies and create a common understanding in a complex project.

The educational activity in Robotics of University of Verona is further completed by the signature of the protocol of the Italian Robotics Network, launched by the Mondo Digitale foundation and supported by most of the Italian Research bodies (Fig. 35).

Main results (papers and realizations of reference people)



Smania, N. Gandolfi, M. Marconi, V. Calanca, Andrea Geroin, C. Piazza, S and Bonetti, P. Fiorini, Paolo Cosentino, A. Capelli, C. Conte, D. Bendinelli, M. Munari, D. Ianes, P. Fiaschi, A. Picelli, A Applicability of a new robotic walking aid in a patient with cerebral palsy, *European Journal of Physical and Rehabilitation Medicine*, Vol. 48, N.1, pp. 47-53, 2012

A. Calanca, S. Piazza, P. Fiorini. A motor learning oriented, compliant and mobile Gait Orthosis. *Journal of Applied Bionics and Biomechanics*, IOS Press ISSN 1176-2322 (Print), 1754-2103 (Online), Vol. 9, N. 1, pp. 15-27, 01/18/2012.

R. Venturelli, O. Akanyeti, F. Visentin, J. Jesov, L. Chambers, G. Toming, J. Brown, M. Kruusmaa, W. M. Megill and P. Fiorini Hydrodynamic pressure sensing with an artificial lateral line in steady and unsteady flows, *Bioinspiration and Biomimetics*, Vol 7, N. 3, (2012) 036004, doi:10.1088/1748-3182/7/3/036004.

Quaglia D., Muradore R., Bragantini R., Fiorini P., SystemC/Matlab co-simulation tool for networked control systems, *Simulation Modelling Practice and Theory*, vol. 23, pp.71-86, 2012.

Michele Scandola, Lorenzo Grespan, Marco Vicentini, Paolo Fiorini, Robot-Assisted Laparoscopic Hysterectomy vs Traditional Laparoscopic Hysterectomy: Five Metaanalyses, *The Journal of Minimally Invasive Gynecology*, Volume 18, Issue 6 , Pages 705-715, November 2011

Riccardo Muradore, Davide Bresolin, Luca Geretti, Paolo Fiorini and Tiziano Villa, Formal Verification of Plans for Robotic Surgery, *IEEE Robotics and Automation Magazine*, September 2011

Riccardo Muradore and Paolo Fiorini, A PLS-Based Statistical Approach for Fault Detection and Isolation of Robotic Manipulators, *Industrial Electronics, IEEE Transactions on* , vol.59, no.8, pp.3167-3175, Aug. 2012, doi: 10.1109/TIE.2011.2167110

J.M. Toibero, F. Roberti, R. Carelli, P. Fiorini Switching control approach for stable navigation of mobile robots in unknown environments. *Journal of Robotics and Computer-Integrated Manufacturing*, 27 (2011) 558568.

D. Zerbato, Dv. Baschiroto, Dn. Baschiroto, D. Botturi, P. Fiorini. GPU Based Physical Cut in Interactive Haptic Simulations. *International Journal of Computer Assisted Radiology and Surgery*, ISSN 1861-6410, pp 1-8, 2010, url = <http://dx.doi.org/10.1007/s11548-010-0505-9>, June 2010.

UniTrento: Summary Table	
Institute	University of Trento, via Mesiano, 77 - 38123 Trento tel. +390461281919
Year of foundation	1962
Reference person	Prof. Mauro Da Lio mauro.dalio@ing.unitn.it Prof. Mariolino De Cecco mariolino.dececco@ing.unitn.it
Website	http://www.unitn.it/ingegneria http://meccablog.ing.unitn.it http://www.robosense.it/ http://www.miro.ing.unitn.it/
Scientific Areas	Mechatronics Intelligent vehicles Artificial vision
Robotic Applications	Robotics for industrial environments
Scientific Expertise	Informatics Control Theory
Team size	9
Senior researchers	3
Year budget (Keuro)	400

Introduction

The robotic activities of the University of Trento are in the frame of the intelligent vehicle, automatic pallet transport, assisted living (human dexterity quantification and rehabilitation), artificial vision and virtual human machine interaction. The frame is the industrial robotics and health care oriented to the technological transfer. The department of industrial engineering, starting from the measurement group, has activities relative to robotic and constitutes the Mechatronic division.

Educational activity

The University of Trento offers courses in robotic field. Students from the University of Trento with robotic background find a qualified job in industries, somebody in local area but, principally, in the north of Italy and in Europe. The courses relative to robotic activities are Mechanical Measurements I, Measurement Systems and Applications, Robotics and Sensor Fusion for Mechatronics Systems.

Research

The main research activities carried on in the Trento's University, linked to robotic, are relative to vehicle dynamics, automatic controls in data storage devices, haptic interfaces, artificial vision, vision-based measurement systems, human machine interfaces, human dexterity quantification and rehabilitation.

Research interests focus on integrated intelligent mechanical systems, with emphasis on modeling simulation and optimal control of mechanical multibody systems, which has been applied to several fields, from space to vehicles.

Interest in vehicles began in 1994, in the area of motorcycle dynamics study (with the motorcycle company Aprilia) when optimal control was used to assess motorcycles maneuverability and handling. Since 2004 the group was involved in a number of EU funded research projects focusing on vehicle dynamics and motion planning based on real time optimal control. Recently, the interests moved to the modeling of human motor skills/capabilities of elder people and people with disabilities. Current research activity is focused on modeling virtual/artificial drivers and ultimately "companion drivers" (by combining Control and Perception-Action paradigm) towards the goal of robotics intelligent vehicles that interact with driver on a peer basis and that cooperates in swarms. The focal point is the concept of Co-driver. Co-Drivers will be able to "understand" human drivers and to form symbiotic systems with them, like a knight with its horse. So far we are dealing of a cooperation between two sentient systems, horse and rider, both intelligent, both interpreting the world and communicating their interpretations to each other.



Fig. 36 - A prototype of automatic guided vehicle

Another activity is the path planning and tracking for non-holonomic vehicles in non-structured environment like Automated Guided Vehicle able to operate inside unstructured warehouses. The goal is to create an autonomous mobile robot able to localize a roughly positioned pallet in a storage area, plan the path for pallet picking and navigate, even for long distances and using obstacle avoidance technique, with no references at known locations in the environment, using laser range finder and odometers.

The system is able to use an enhanced dead reckoning system performing an error of 0.1 m on a path of 50 m long. Simulator and SLAM (Simultaneous Location & Mapping) was also realized.

Artificial vision is used to capture human body motion working in medical analysis area (i.e. breath analysis) and also in industrial material deformation. For the human body a suit with about 3000 markers are used and the image is collected by twelve cameras. The system does not need to guess an a-priori model. This means that, also if some limbs are not visible, only the parts that move are extracted, together with their relative motions. Moreover, the calibration procedure is very simple and has no interference with natural motion of the subject.



Fig. 37 - Acquisition of the human body movement

The group has cooperation with the principal universities of Italy, the Centre for Research and Technology Hellas and the Institute for system and Robotics of Lisbon.

The group has cooperation with the principal universities of Italy, the Centre for Research and Technology Hellas and the Institute for system and Robotics of Lisbon.

Funded projects

PREVENT is a European automotive industry activity co-funded by the European Commission to contribute to road safety by developing and demonstrating preventive safety applications.

SAFERIDER aims to study the potential of Advanced Driver Assistance system integration on motorcycles for the most crucial functionalities and develop efficient and rider comfort.

INTERACTIVE aims at developing a new integrated onboard safety function system(s). The University of Trento is involved in this project with the role to develop an artificial co-driver, “who” will act like a tutor surveilling and understanding the driver behavior and seamlessly suggesting to the Human Machine Interface proper corrective actions, if and only when needed. The idea is that the system will provide “Continuous Support” an a non-obtrusive way, virtually disappearing when there is no need for it, but being ready to help the driver and recall his/her attention when that is needed.

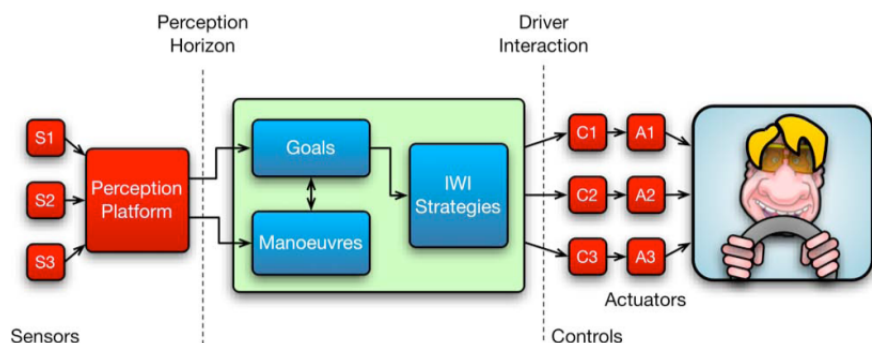

Fig. 38 - Co-Driver for Continuous Support function in interactive project

The idea is that the system will provide “Continuous Support” an a non-obtrusive way, virtually disappearing when there is no need for it, but being ready to help the driver and recall his/her attention when that is needed.

VERITAS aims to develop tools for built-in accessibility support at all stages of ICT and non-ICT product development. The goal is to introduce simulation based and virtual reality testing into the automotive, smart living spaces (buildings and construction, domotics), workplace, healthcare and infotainment applications areas. The goal is to ensure that future products and services are being products and services are being systematically designed for all people, including those with disabilities and functional limitations as well as older people. To test the validity and applicability of these virtual user models in real accessibility testing scenarios using an innovative multisensorial platform.

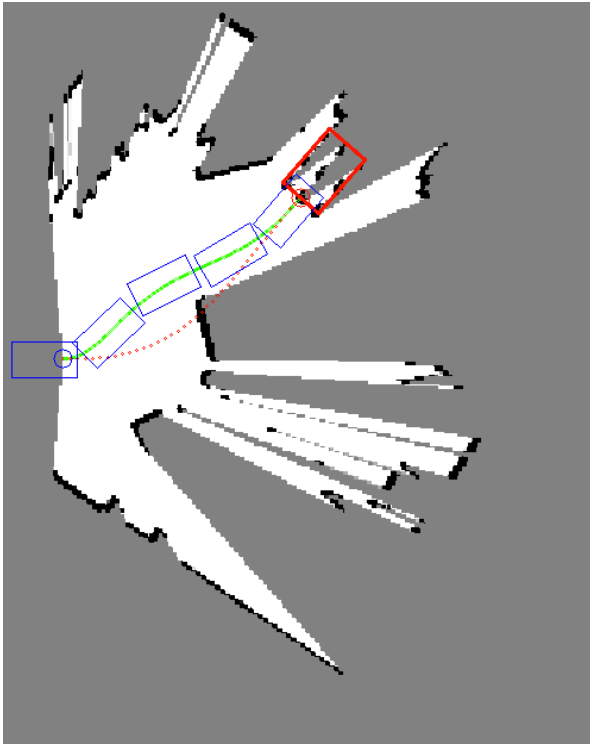

Fig. 39 - Pat Planning with Cubic Clothoids

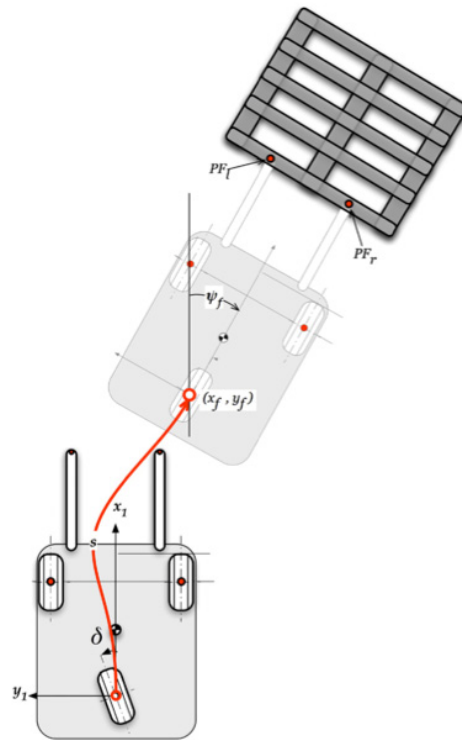

Fig. 40 - Pat Planning with Cubic Clothoids

AGILE to develop an intelligent Automated Guided Vehicle that offers higher flexibility paired with better reliability and safety for the use in non-structured industrial environments. The idea of the project is to develop a small, robust and flexible AGV for semi- or non-structured warehouses targeted to the needs of medium sized enterprises. The AGV will be able to identify and estimate the location of a pallet, to automatically reach the pallet for loading, carry the pallet and unload it at a defined location. Thereby it needs to cope with indoor and outdoor industrial environments, where artificial landmarks for AGV navigation can be missing, or achieve a low reliability level, while pallets are stored in not well defined positions. The project partners are the SME partners Fusion Systems and Digipack and the academic partner is the Department of Mechanical and Structural Engineering at the University of Trento.

Other activities

The University of Trento is also working on commission by companies; it has automatized a transport pallet on demand by ZARA, a pasta factory.

It has founded a startup, RoboSense (ROSE), to use autonomous forklifts, logistics automation or automatic packaging, manipulator using artificial vision and a human body scanner, a motion capture system for rehabilitation.

ROSE was born in October 2012 as a startup enterprise of the University of Trento and its mission is to work in the technological transfer from the research level to the business field.

It is the result of the union of the people that constitute Measurements Research Group of the Department of Mechatronic Engineering of the University of Trento, formed in the early 2000's.

The business is related to Robotics, Computer Vision and the Automation in general. Commercial product is SmartFinder, a solution for automatic pallet picking. By this device the Automatic Guide Vehicles working inside the automatic warehouses can obtain a further level of Artificial Intelligence permitting an higher level of automation, identifying autonomously the pallets inside the environment and at the same time monitoring the picking procedure in order to achieve a fast, automatic and safe logistic service.

The human body capture was realized by Gamocap a Total Body Motion Tracking System. Using a simple garnet and a multicamera setup it is able to track and return a cloud of 3000 points fixed on human body.

Facilities

The laboratory has the following facilities and equipment:

Manufacturing:

- 5 axes NC milling machine (Deckel Maho DMU 60T)

Metrology and rapid prototyping:

- 3 axes cartesian CMM (DEA Global Image 777)
- atomic force microscope (Burleigh)
- portable rugosimeter
- rapid prototyping machine (Stratasys Dimension)

Surface physics characterization:

- Ultra high vacuum chamber with inertial suspension system for momentum transfer measurements

Electronics and measurements:

- 2 spectrum analyzers
- 2 function generators
- National Instruments PXI
- National Instruments CompactRIO
- Multifunction switch/datalogger
- MicronOptics si425 Wavelength Division Multiplexing laser spectrometer for fibre optics Bragg gratings
- Transducers and various measurement devices

Computation:

- 8-CPU cluster (4 Apple XServe modules)

Team

Mauro Da Lio, is a full Professor at University of Trento and is at the head of the Mechatronic Research Group. He obtained a degree in Mechanical Engineering from University of Padua. He is Associate Editor of IEEE Transaction of Intelligent Transportation systems since 2008.



Mariolino De Cecco, is associate Professor of “Mechanical and Thermal Measurements” and “Robotics and Data Fusion” at the Faculty of Engineering, University of Trento. Member of the Industrial Engineering department.



Main areas of interest. Mechanical measurements: development of innovative measurement systems, vision systems for 3D shape estimation, measurement systems for characterization and modeling human motion and human-machine interaction, systems for industrial diagnostics. Mobile robotics: SLAM (Simultaneous Location and Mapping for mobile robots) using lidar, trajectory planning and control of autonomous vehicles AGV. Aerospace systems: development of sensors and mechanisms, definition and coordination of qualification plans, control for non holonomic robot.

Publications

Afanasyev, I., Lunardelli, M., Biasi, N., Baglivo, L., Tavernini, M., Setti, F., & De Cecco, M. (2012). 3D human body pose estimation by SuperQuadrics. Paper presented at the VISAPP 2012 - *Proceedings of the International Conference on Computer Vision Theory and Applications*, 2 294-302.

Amditis, A., Bertolazzi, E., Bimpas, M., Biral, F., Bosetti, P., Da Lio, M., . . . Sjögren, A. (2010). A holistic approach to the integration of safety applications: The INSAFES subproject within the european framework programme 6 integrating project PRéVENT. *IEEE Transactions on Intelligent Transportation Systems*, 11(3), 554-566.

Amditis, A., Bimpas, M., Thomaidis, G., Tsogas, M., Netto, M., Mammar, S., . . . Cicilloni, R. (2010). A situation-adaptive lane-keeping support system: Overview of the SAFELANE approach. *IEEE Transactions on Intelligent Transportation Systems*, 11(3), 617-629.

Baglivo, L., Biasi, N., Biral, F., Bellomo, N., Bertolazzi, E., Da Lio, M., & De Cecco, M. (2011). Autonomous pallet localization and picking for industrial forklifts: A robust range and look method. *Measurement Science and Technology*, 22(8)

Bertolazzi, E., Biral, F., & Da Lio, M. (2007). Real-time motion planning for multibody systems: Real life application examples. *Multibody System Dynamics*, 17(2-3), 119-139.

Bertolazzi, E., Biral, F., Da Lio, M., Saroldi, A., & Tango, F. (2010). Supporting drivers in keeping safe speed and safe distance: The SASPENCE subproject within the european framework programme 6 integrating project PRéVENT. *IEEE Transactions on Intelligent Transportation Systems*, 11(3), 525-538.

Bertolazzi, E., Biral, F., Lio, M. D., & Galvani, M. (2010). Curve warning driver support systems. A sensitivity analysis to errors in the estimation of car velocity. Paper presented at the *IEEE Conference on Intelligent Transportation Systems, Proceedings*, ITSC, 180-185.

Biral, F., da Lio, M., Lot, R., & Sartori, R. (2010). An intelligent curve warning system for powered two wheel vehicles. *European Transport Research Review*, 2(3), 147-156.

Confalonieri, M., Guandalini, G., Da Lio, M., & De Cecco, M. (2012). Force and touch make video games ‘serious’ for dexterity rehabilitation. Paper presented at the Studies in Health Technology and Informatics, 177 139-144.

Da Lio, M., Biral, F., Galvani, M., & Saroldi, A. (2012). Will intelligent vehicles evolve into human-peer robots? Paper presented at the *IEEE Intelligent Vehicles Symposium*, Proceedings, 304-309.

De Cecco, M., Pertile, M., Baglivo, L., Lunardelli, M., Setti, F., & Tavernini, M. (2010). A unified framework for uncertainty, compatibility analysis, and data fusion for multi-stereo 3-D shape estimation. *IEEE Transactions on Instrumentation and Measurement*, 59(11), 2834-2842.

Kirchner, M., De Cecco, M., Confalonieri, M., & Da Lio, M. (2011). A joint force-position measurement system for neuromotor performances assessment. Paper presented at the MeMeA 2011 - 2011 *IEEE International Symposium on Medical Measurements and Applications*, Proceedings.

Miori, G., Parzianello, G., De Cecco, M., Cristofolini, I., Trevisan, C., Boselli, G., . . . Da Lio, M. (2009). A new method for numerical simulation of 3D motion effects on motion and roundness reconstruction based upon parametric mathematical modelling. Paper presented at the *Proceedings of the IASTED International Conference on Applied Simulation and Modelling*, ASM 2009, 98-105.

Pertile, M., De Cecco, M., & Baglivo, L. (2010). Uncertainty evaluation in two-dimensional indirect measurement by evidence and probability theories. *IEEE Transactions on Instrumentation and Measurement*, 59(11), 2816-2824.

Setti, F., Bini, R., Lunardelli, M., Bosetti, P., Bruschi, S., & De Cecco, M. (2012). Shape measurement system for single point incremental forming (SPIF) manufactures by using trinocular vision and random pattern. *Measurement Science and Technology*, 23(11).

Tuscany

An excellence in Italian robotics

The Biorobotics Institute together with the Robotics groups working at Pisa University (Centro Piaggio) represent a unique examples at international level of the capabilities of Italian research at all and in robotics in particular, so that the Pisa Area can be probably evaluated as one of the most significant Italian areas.

Nevertheless, the excellence of Toscana area in robotics research is not limited to the Pisa area, Universities of Siena and Florence also gained an large and honoured international reputation and what is at least of not less importance this coordinated reality of research is pushed and supported by a Regional policy that is perhaps unique in Italy with respect to the interest and the importance given to technology and research investments.

Also, many local authorities are pushing the development of many innovations in the field of robotics and automation and also creating the conditions to generate effective technology transfer from academy to industry especially by means of projects thoughts in support of territory needs (control of pollution, support to the huge cultural heritage goods), but realized developing new and more advanced technologies to fulfill the requests.

The Toscana area has been also addressed as one of the most interesting source of brains by the Italian Institute of Technologies that fired in this way one of the most prominent cooperation agreements among those started up by this foundation in the last years.

The Biorobotics Institute - Scuola Superiore S.Anna

SSSA: Summary Table	
Institute	Polo Valdera - Scuola Superiore Sant'Anna, Viale R. Piaggio 34, Pontedera, Pisa - Italy
Year of foundation	2002
Reference person	Prof. Paolo Dario, Prof. Cecilia Laschi
Website	http://sssa.bioroboticsinstitute.it/
Scientific Areas	Artificial intelligence Machine Learning Autonomous robots Sensors and perception Biorobotics Mechatronics
Robotic Applications	Medical Robotics Assistive Robotics
Scientific Expertise	Mechanical Design Mechanical Development Materials Technologies Systems Engineering and Electronic Design Informatics Control theory Signal processing Neuroscience
Team size	150
Senior researchers	12

Mission

“The mission of the BioRobotics Institute is educating the Engineer of the 21st Century, a competent, interdisciplinary, creative inventor and entrepreneur, able to manage new technological and scientific challenges, ready to take up new opportunities for society and industry, and acting as a linking bridge towards centres of knowledge worldwide.” (Paolo Dario).

In terms of contents, biorobotics has three main areas: robotics for therapy and surgery, robotics for rehabilitation and assistance, bioinspired and biomimetic robotics. The BioRobotics Institute aims at the smooth and systematic transition from high quality education, to “frontier” research and to exploitation of human resources and research results.”

Introduction

The Institute of BioRobotics in Polo S. Anna/Valdera, directed by Prof. Paolo Dario, is probably the most important research center in robotics in terms of its historical results, in terms of scientific production and in terms of active people. Polo Sant’Anna Valdera was established in 2002 in Pontedera (Pisa) in front of the industrial plant of Piaggio. The Biorobotics institute is the result of a merge of Arts, Crim and EZ laboratories that worked on Advanced Robotics Technology, Microengineering and technologies for longevity respectively.

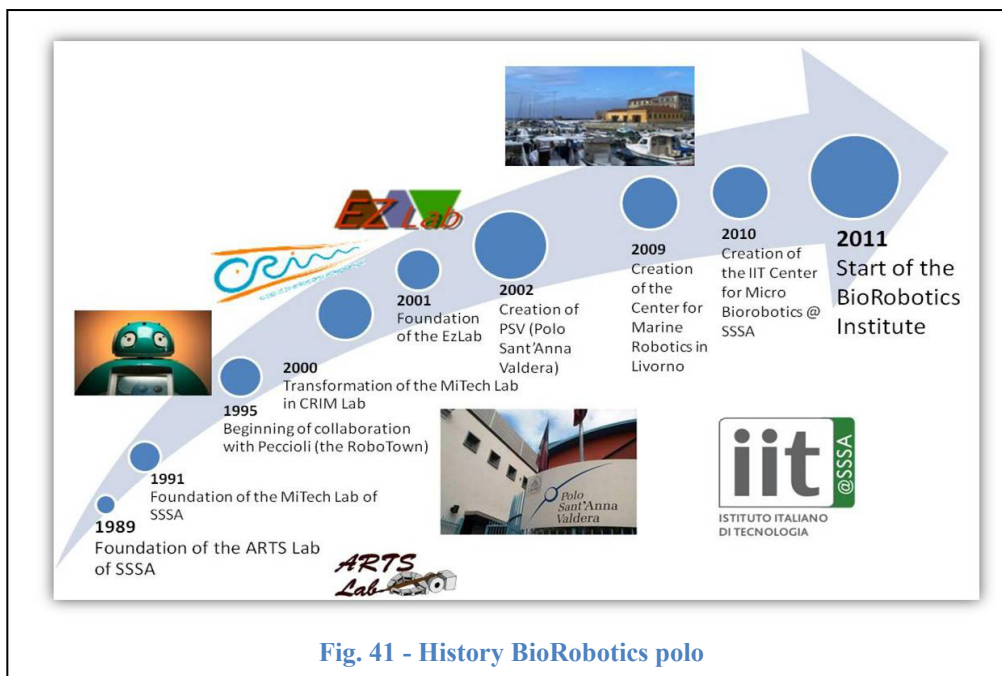

Fig. 41 - History BioRobotics polo

Areas of interest

The Institute of BioRobotics is structured along the research lines of:

- Future and Emerging BioRobotics
- Humanoid Robotics
- Neuro-Robotics
- Surgical Robotics
- Soft Robotics
- Neural Engineering
- Creative Design
- Biomedical Signal Processing.

General information about these departments can be easily found in their website <http://sssa.bioroboticsinstitute.it/>.

Cooperation and collaboration agreements

S. Anna Biorobotics Institute has also established a number of cooperation agreements inside and outside of Italy; in the following picture (Fig. 42) a list of cooperation agreements currently active within the Region Toscana are reported. One of them, perhaps the most recent one has been established with the Livorno administration with the purpose to realise marine surveillance robotics systems against the diffusion of pollutants. Many other cooperation agreements have been established in Italy and also with other international organizations (Fig. 43). IIT has recently established in 2009 the Center of MicroBiorobotics (CMBR) at Polo Sant’Anna Valdera where they share facilities and know-how on different fields of biorobotics.

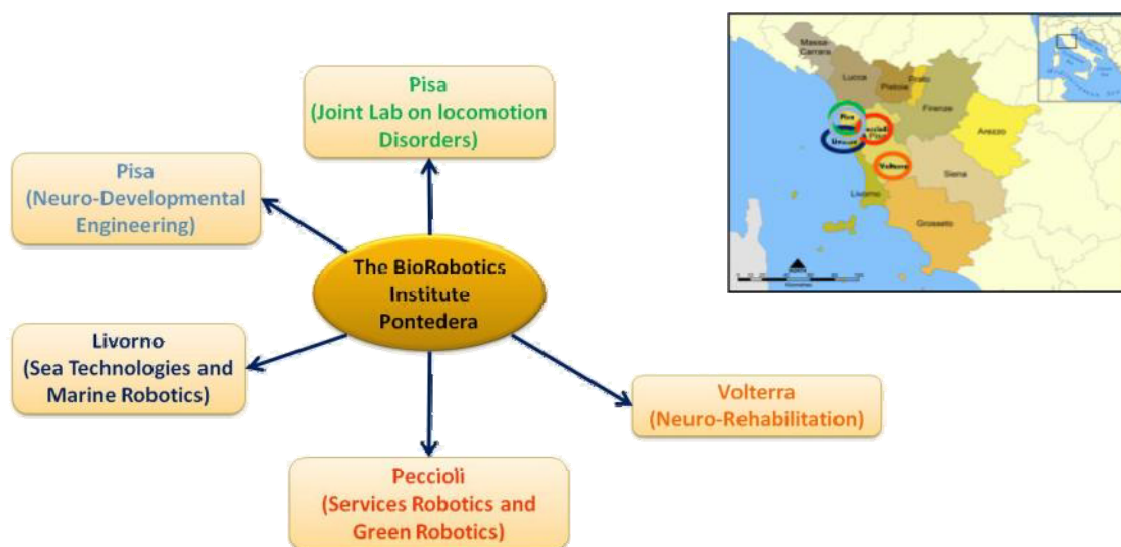

Fig. 42 - Cooperation of Biorobotics Institutes inside Toscana

Joint Laboratories

Joint Laboratory with ST-Microelectronics in Catania



Center for Micro-BioRobotics
 STAFF: 39 People
 BUDGET: ~ 3 MC / year



Fig. 43 - Worldwide joint laboratories

A complete description of the results of S. Anna Biorobotics activity is perhaps too heavy for the purposes of this report and we will shortly resume here some of the more recent activities together with general comments.

In the bottom pictures (Fig. 44) a quick panorama of the work recently carried within the line of soft robotics is shown. The core of the projects is the study of different approaches to the motion and actuation problem, studying the examples given in many natural animals together with the attempt to replicate them and to create the know-how for a subsequent replication in the human world application (for instance in realizing surgical “soft” tools).

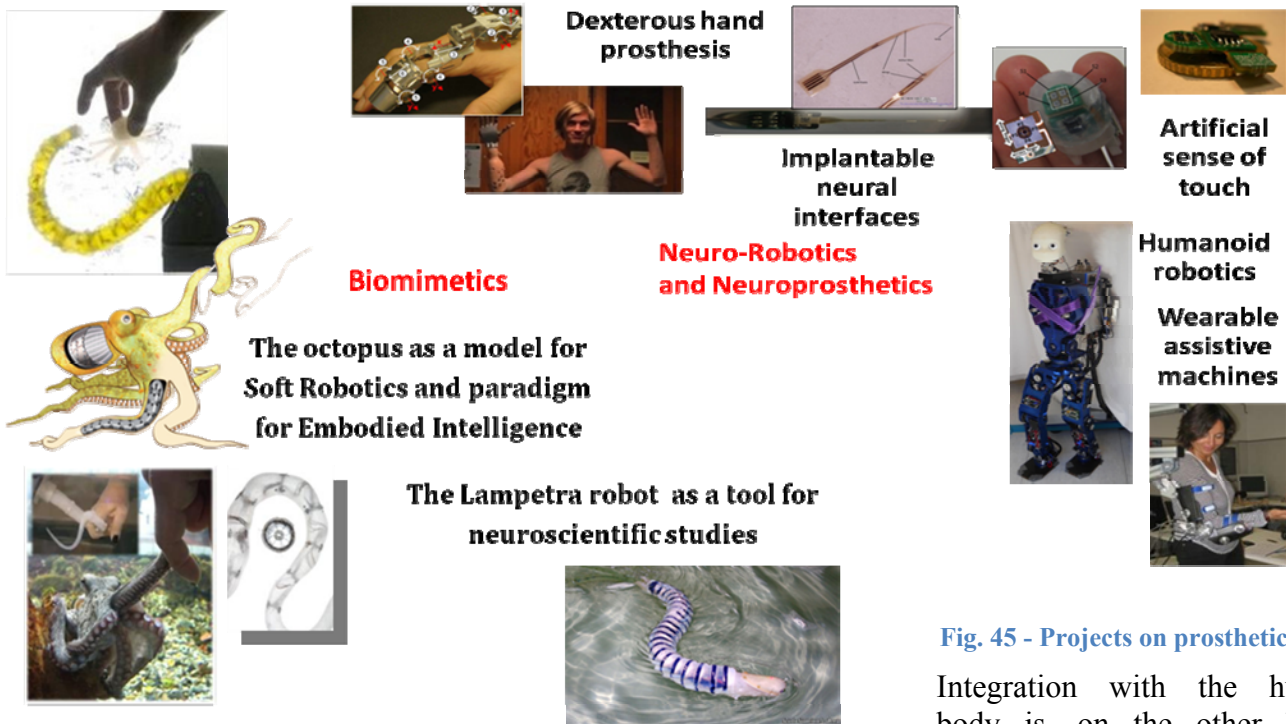

Fig. 44 - Soft robotics projects

Fig. 45 - Projects on prosthetics

Integration with the human body is, on the other hand, another of the main interest of Biorobotics institute and several

projects, starting from the study of hand prosthesis to the realization of interfaces between the neural system and electronic systems and drivers (Fig. 45).



Fig. 46 - Garbage collection at Peccioli

In general, most of the Biorobotics institute activities are characterized by a hybrid approach that is typical of the European FET initiative.

Following this approach, robotics is no more the classical study of the control of movement of rigid bodies, the optimization of speed, energy, precision and possibly intelligence in carrying out this tasks, but is the study of self-

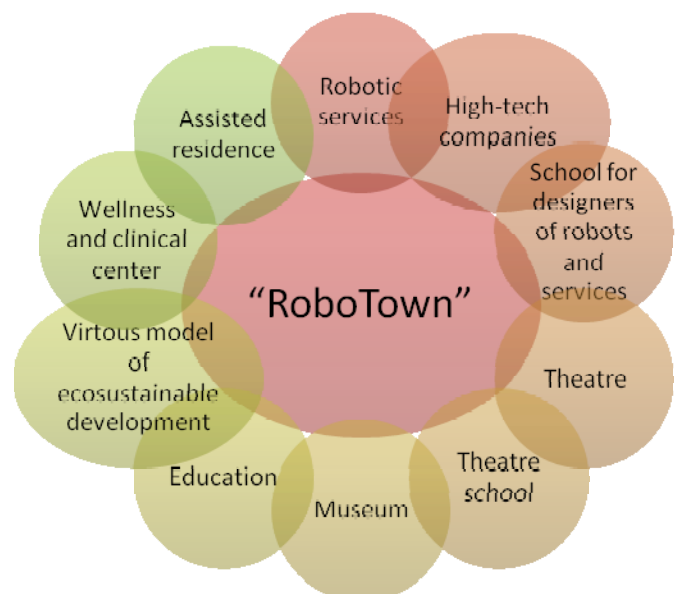

Fig. 47 - Application of robotics to “smart cities”

adaptation of rigid, flexible or soft bodies to environment and tasks using non-conventional technologies, including new materials, nanocomponents and others. A sort of engineering for “artificial” evolution of “artificial beings”.

Approaching to the introduction of robotics into the everyday life (see Fig. 47 - Application of robotics to “smart cities” - service robotics), S. Anna developed a concept shown in the picture (Fig. 46) and developed and tested a first approach oriented to the testing of “door to door” garbage collection. The testing has been carried out in Toscana little center, Peccioli, involving a public of 24 families and about 10 commercial activities. A satisfaction poll has been carried out after the testing period showing a good 95% of positive opinion expressed.

In the medical robotics topic, S. Anna is also strongly engaged with the particular target of rehabilitation. In the following we reported some their main realizations, coming from the cooperation with clinical centers in Toscana:

- Auxilium Vitae Volterra

(joint Rehabilitation Bioengineering Lab): 170+ patients

- Largest number of stroke patients treated in clinical practice in Europe
- 5 experimental clinical trials: largest RCT clinical trial on subacute stroke patients in Europe (Telerehabilitation and Robotics Regional Health Research Program 2009)
- European Network on Robotics for NeuroRehabilitation (COST Action TD1006)
- Pisa University Hospital: 40 patients

- Fondazione Stella Maris (IRCCS):

- Center of excellence in Italy specifically focused in child and adolescent neurology and psychiatry
- first studies on the development of new innovative tools for quantitative diagnosis and therapy in the first year of life
- more than 25 infants (CP, Down Syndrome, ASD)

Owing to their special characterization of multidisciplinary robotics and the international contacts with FET environment, BioRobotics Institute of S. Anna is one of the few Italian centers involved in the presentation of the large European Commission of research initiative Flagships.

“RoboCom”, one of the six finalist projects among the 26 Consortia that participated to the contest, was led by the Italian Institute of Technology as organization and by Prof. Paolo Dario, Director of the Biorobotics Institute, as Scientific Director.

BioRobotics Institute is also one of the leaders of the regional Flagship of Toscana.

Educational activity

S. Anna is engaged in the promotion of robotics themes towards the lower grade school, from the asylum to the high school. The target Institutes are quite obviously those in the area of Pontedera/Pisa, where S. Anna is located. Among the tools that are exploited to carry out this activity, mainly afforded to postdoc students, there are the performing of structured courses held at S. Anna site, repeated each year towards students and teachers, seminars to school sites and the preparation of Instruction Laboratories to the participating school institutes sites. It is to point out that some funds for this activity are irregularly found by calls of the Ministry of Research.

Considerations

Most of the initiatives and the projects are carried out by the students: the institute can count on about 150 students per year that are driven by about 12 highly skilled professors. This creates a critical situation for some funding tools because, whereas the students can carry out a considerable amount of scientific work, under the point of funding they cannot be taken into account in terms of investment in

many funding mechanism. This imply a limit that can become sometimes severe to the capability of the organization to procure resources for its many research projects.

Another problem that demonstrated to be common to many other academic research centers is the maintenance of the developed know-how. The mean time devoted to projects is generally three years, both for the duration of the typical funded projects, and both for the typical stay of most of the students on the Institute.

When a project is finished, a large extent of the know-how of the project itself can be considered dead, most of the times because the people that contributed to build up and to operate the tools and the demonstration prototypes is left. Also the continuous change of the funded projects, with its continuously different targets contribute to this problem. At Biorobotics the know-how loss effect is partially smoothed thanks to the presence of a number of Technicians that contribute to maintain some knowledge about the operation of the various produced equipment.

Main results (papers and/or realizations of reference people)

P. Dario, A. Menciassi, “Robot Pills”, /Scientific American/, vol.303,2; p.62-65, ISSN: 0036-8733, 2010.



Cianchetti, M., Arienti, A., Follador, M., Mazzolai, B., Dario, P., Laschi, C. “Design concept and validation of a robotic arm inspired by the octopus”, /Materials Science and Engineering C/, Vol.31, 2011, pp. 1230-1239.

C. Laschi, B. Mazzolai, M. Cianchetti, L. Margheri, M. Follador, P. Dario, “A Soft Robot Arm Inspired by the Octopus”, /Advanced Robotics (Special Issue on Soft Robotics)/, Vol. 26, No. 7, 2012.



Salvini P., G. Teti, E. Spadoni, C. Laschi, B. Mazzolai, P. Dario, (2011).Peccioli: The Testing Site for the Robot DustCart. Focus on social and legal challenges/, IEEE Robotics and Automation Magazine, Special Issue on Roboethics, Vol.18, No.1, 2011, pp.59-67./

Salvini P., G. Teti, E. Spadoni, E. Frediani, S. Boccialatte, L. Nocco, B. Mazzolai, C. Laschi, G. Comandé, E. Rossi, P. Carrozza, P. Dario, (2010) An Investigation on Legal Regulations for Robot Deployment in Urban Areas: A Focus on Italian Law, /Advanced Robotics/, Vol. 24, 2010, pp. 1901-1917.

Stefanini, C; Orofino, S; Manfredi, L; Mintchev, S; Marrazza, S; Assaf, T; Capantini, L; Sinibaldi, E; Grillner, S; Wallen, P; Dario, P, “A novel autonomous, bioinspired swimming robot developed by Neuroscientists and bioengineers”, /Bioinspiration & biomimetics/, Volume: 7 Issue: 2 Pages: 025001 DOI: 10.1088/1748-3182/7/2/025001 Published: 2012-Jun

A. Menciassi, G. Ciuti, M. Salerno, G. Lucarini, P. Valdastris, A. Arezzo, M. Morino, P. Dario, “A Comparative Evaluation of Control Interfaces for a Robotic-Aided Endoscopic Capsule Platform”, IEEE TRANSACTIONS ON ROBOTICS Volume: 28 Issue: 2 Pages: 534-538 DOI: 10.1109/TRO.2011.2177173 Published: APR 2012



Carrozza M.C.; Cappiello, G; Micera, S; Edin, BB; Beccai, L; Cipriani, C, “Design of a cybernetic hand for perception and action”, BIOLOGICAL CYBERNETICS Volume: 95 Issue: 6 Pages: 629-644 DOI: 10.1007/s00422-006-0124-2 Published: DEC 2006

Colombo, R; Pisano, F; Micera, S; Mazzone, A; Delconte, C; Carrozza, MC; Dario, P; Minuco, G, “Robotic techniques for upper limb evaluation and rehabilitation of stroke patients”, IEEE TRANSACTIONS ON NEURAL SYSTEMS AND REHABILITATION ENGINEERING Volume: 13 Issue: 3 Pages: 311-324 DOI: 10.1109/TNSRE.2005.848352 Published: SEP 2005



The E. Piaggio Institute – University of Pisa

Pisa University: Summary Table	
Institute	Piaggio Institute
Year of foundation	
Refererence person	Prof. Antonio Bicchi
Website	http://www.centropiaggio.unipi.it/
Scientific Areas	Embedded and Networked Control, HRI, Hands and Haptics, Mobile Robotics , Physical Human-Robot Interaction, Artificial Senses and Muscles, Human-Machine Social Emotional Interaction, Affecting Computing, Wearable Monitoring Systems, Underwater Robotics
Robotic Applications	Environmental Surveillance, Service Robotics, Support to human person, Industrial Automation
Scientific Expertise	Mechanical Design, Control Theory, Informatics, Signal Processing , Artificial Intelligence
Team size	70
Senior Researchers	15

Introduction

The E. Piaggio Institute is a centre for advanced robotics studies directed by Prof. Antonio Bicchi with the original aim to foster studies and research for automation in industry. With this mission it was created in 1965 with the name of “Centre for Automatica” under the direction of Alessandro Faedo, mathematician that also the responsibility of Dean of Pisa University and, later, Italian republic senator.

Currently E. Piaggio research centre become an independent institution inside Pisa University, with some administrative features typical of the University Departments in the Italian university organisation.

Under the scientific point of view Piaggio Institute is now concentrated on several themes of Robotics and BioEngineering, also if still maintains a part of its original focus on mechanical studies, but widening its range of interests to the topics of man-robot relationships, Artificial Intelligence, coordination of robots in teamwork and many others.

Areas of Interest

The Piaggio Institute, as before mentioned, shares its interests between bioengineering and classical robotics fields, having in mind that also BioEngineering is also aimed at a different branch of robotics. This is in fact how the researchers of BioEngineering area of Piaggio Institute will define themselves:

“Biomedical Engineering in Pisa has its roots in the Piaggio Center. Multidisciplinary by its very nature, the research on Bioengineering is directed at studying, mimicking, and supporting the human body using dry and wet materials, sensing and actuation and intelligent wetware, software and hardware. The Center is also a hub for Biomedical Engineering students“.

Under the classical robotics point of view Institute Piaggio is one of the first and of the most prominent study centre in the world to develop the idea and the importance of compliance both at the control and at the mechanical level. Compliance includes the concept of soft robotics, currently largely studied in the world, to increase the compatibility of robots with human beings, but doesn't limit the “softness” to the surface layer of the machines, but goes in depth, transferring this concept to the operation and the control itself of the machines. Robots must be compatible with human beings up to their inner operation.



Fig. 48 - Networked Control - A Modular and Layered Cosimulator for Networked Control Systems

To realise this goal, several technologies are simultaneously applied, including the technique that allow to control a multi-link and multibody system through a networked control, studying the delay effects, the coordination rules, the software organisation and many other approaches (see as an example Fig. 48 at the side).



Fig. 49 - HE First Hand grasps trials: scissor (left side), syringe (middle) and stapler (right side)

Also the studies for the development and the control of multiDOF and efficient hands are part of this philosophy (see for instance Fig. 49 and Fig. 50) and project like “SOFTHANDS, a theory of soft synergies for a new generation of artificial hands”, funded by ERC, are the support to carry out this top level activity.

A relatively recent interest area that involved many studies on the cooperation among team of robots was the study of the behaviour of underwater autonomous vehicles (AUV) operating together to shorten and make more accurate explorations, monitoring and control, search and rescue missions. Piaggio institute was charged with this objectives under the push of Regione Toscana putting together with other research centres of Toscana (Firenze, WASS at Livorno) to

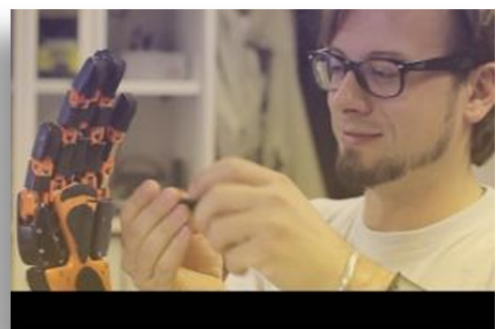

Fig. 50 - The Hand Embodied Project

study the problem of pollution monitoring of the Toscana coasts and, in another project (Thesaurus), the technology to discover and study underwater shipwrecks with their relics of ancient times, important part of Cultural Heritage of the region.



Fig. 51 - Tifone, vehicle for sea bottom patrolling designed by Piaggio Institute

The group developed both new AUVs (in particular the Tifone, shown in Fig. 51), with the task to cooperate in teams of three units, able to exchange information and coordinate their own operations, mechanical actuators (especially for marine propulsion) and local and social intelligence.

Cooperation and collaboration agreements

Piaggio Institute, like in the case of Scuola Superiore S. Anna, has established a large network of national and international relationships that allow him to be considered one of the poles of the world robotics research especially in the area of compliant robotics.

His director, Prof. A. Bicchi, postdoc scholar at MIT, is senior scientist at IIT and one of the most respected researchers at international level.

Prof. Bicchi is also the elected Chair of the Italian Association

At national level, in the recent years, Piaggio Institute became one of the founders of the Interuniversity Center of Integrated Systems (ISME), mentioned also for the other members of the group. This university association has already proven to be able to successfully compete at international level with a number of approved projects.

Among them we can mention CO³AUVs, Trident, UAN, VENUS, EPOCH (a NoE), SITAR.

Educational Activity

Piaggio Institute, despite the activities related to its institutional role of University department, was deeply involved in the exchange of technology, information and cultural initiatives with the surrounding territory. It is one of the main generators of high tech SMEs that are hosted, during all the first phases of their startup in infrastructures owned by University and that allow the young enterprises to establish their first core business before being launched on the competitive market.

Among these we can mention high tech industries like QROBOTICS, specialized in soft robotics technologies, ADATEC, a wide spread technology firm, especially involved in informatics and robotics, Kirkstall, more involved in biotechnology applications, Pure Power Control, made by specialists in engineering services, especially with reference to powertrains and their control.

But apart the special support to these firms, launched by students of the University itself, Piaggio Institute opened a fixed consultant office, operating towards all the surrounding industrial district, able to offer technological solutions to support new and innovating industrial initiatives.

With this respect and with the support of Regione Toscana (pianeta Galileo), Piaggio Institute is also organizing regular lessons addressed to young specialists of local industries willing to improve their level of education and increase their industry innovation capability.

Main results (papers and/or realizations of reference people)

Bianchi M, Salaris P, Bicchi A. Synergy-Based Hand Pose Sensing: Optimal Glove Design. International Journal of Robotics Research. 2013;32(4):396-406.DOI Google Scholar BibTex RTF Tagged XML RIS [PDF] (5.72 MB)



Bianchi M, Salaris P, Bicchi A. Synergy-based Hand Pose Sensing: Reconstruction Enhancement. International Journal of Robotics Research. 2013;32(4): 407-424.DOI Google Scholar BibTex RTF Tagged XML RIS [PDF] (1.52 MB)

Grioli G, Catalano MG, Silvestro E, Tono S, Bicchi A. Adaptive Synergies: an approach to the design of under-actuated robotic hands. In: International Conference of Intelligent Robots and Systems - IROS 2012. International Conference of Intelligent Robots and Systems - IROS 2012. Vilamoura, Algarve, Portugal; 2012. p. 1251 - 1256 .

Bicchi A, Bavaro M, Boccadamo G, Carli DD, Filippini R, Grioli G, Piccigallo M, Rosi A, Schiavi R, Sen S. Physical Human-Robot Interaction: Dependability, Safety, and Performance. In: Proc. 10th Intl. Workshop Advanced Motion Control. Proc. 10th Intl. Workshop Advanced Motion Control. ; 2008. p. 9-14.

Caiti A, Munafò A, Vettori G. A geographical information system (GIS)-based simulation tool to assess civilian harbor protection levels. IEEE JOURNAL OF OCEANIC ENGINEERING [Internet]. 2012;37:85–102. Available from: <http://dx.medra.org/10.1109/JOE.2011.2174675>DOI Google Scholar BibTex RTF Tagged XML RIS



Marino H, Bonizzato M, Bartalucci R, Salaris P, Pallottino L. Motion Planning for Two 3D-Dubins Vehicles with Distance Constraint. In: International Conference of Intelligent Robots and Systems - IROS 2012. International Conference of Intelligent Robots and Systems - IROS 2012. Vilamoura, Algarve, Portugal; 2012. p. 4702 - 4707 .Google Scholar BibTex RTF Tagged XML RIS [PDF] (895.33 KB)



Salaris P, Pallottino L, Bicchi A. Shortest Paths for Finned, Winged, Legged and Wheeled Vehicles with Side-Looking Sensors. International Journal of Robotics Research. 2012;31(8):997-1017.DOI Google Scholar BibTex RTF Tagged XML RIS [PDF] (3.38 MB)

Caiti A, Calabrò V, Dini G, Duca LA, Munafò A. Secure Cooperation of Autonomous Mobile Sensors Using an Underwater Acoustic Network. SENSORS [Internet]. 2012;12:1967–1989.

Balestrino A, Caiti A, Grammatico S. A new class of Lyapunov functions for the constrained stabilization of linear systems. AUTOMATICA [Internet]. 2012.

Drap P, SEINTURIER J, Conte G, Caiti A, Scaradozzi D, ZANOLI SM, GAMBONI P. Underwater cartography for archaeology in the VENUS project. GEOMATICA. 2008;62:419–427.

Scilingo EP, Bianchi M, Vanello N, Hartwig V, Landini L, Bicchi A. Artificially Rendered Cutaneous Cues for a New Generation of Haptic Displays. In: Springer Series on Touch and Haptic Systems - part 2. Vol. Immersive Multimodal Interactive Presence. Springer Series on Touch and Haptic Systems - part 2. ; 2012. p. 171 - 188.



Vanello N, Hartwig V, Tesconi M, Ricciardi E, Tognetti A, Zupone G, Scilingo EP, Giovannetti G, Positano V, Santarelli MF. A sensing glove for enhancing exploration of brain functions in haptic tasks. In: Patron First National Congress of Bioengineering. First National Congress of Bioengineering. Pisa; 2008. p.



Bicchi A, Scilingo EP, Ricciardi E, Pietrini P. Tactile flow explains haptic counterparts of common visual illusions. Brain Res Bull. 2008;75:737-741.

Central Italy

What we defined with Central Italy geographically includes the Regions down south Emilia and Toscana, covering at least Marche, Umbria, Lazio, Abruzzo, Molise. Owing to the large relevance represented by the Rome area, we adopted the criteria to present in a separate chapter the research of this area with respect to the other groups of the central Italy, but it is to be considered that Rome area is under aspect deeply integrated with the other universities and Research centres, not only for proximity reasons, but also because the roman universities exports many high level professors and lecturers to the near campuses of Ancona, Perugia, L'Aquila, Cassino, Viterbo and others.

Apart from that, the network of national cooperation and integration of the middle of Italy Academies, is large and include most of the northern universities and Naples that is also a strong reference point of the Robotics national research.

In terms of exploitable public resources, central Italian academies are not among the most riches. The reasons generally are in the reduced basin of population and therefore in the number of students that are signed to the Institutes. Industries, on the other hands, are often featured by traditional activities and only some geographical place (for instance the wood industry, close to Pesaro) host advanced and innovative firms.

DII - Università Politecnica delle Marche

DII: Summary Table	
Institute	Università Politecnica delle Marche, Via Brezze Bianche, Ancona
Year of foundation	2011
Reference person	Prof. Giuseppe Conte (g.conte@univpm.it) and Prof. David Scaradozzi (d.scaradozzi@univpm.it)
Website	http://www.dii.univpm.it/
Scientific Areas	Artificial intelligence, Distributed Robotic Systems, Underwater Robotics, Mechatronics, Sensors and perception
Robotic Applications	Robotics for hostile environments, Service robotics, Industrial robotics
Scientific Expertise	Informatics Signal Processing Control Theory Mechanical Design
Team size	20
Senior researchers	3

Introduction

The Information Engineering Department (DII) has been established in 2011, from the merging of the Department of Biomedical, Electronics and Telecommunications Engineering and the Department of Informatics, Management and Automation Engineering.

DII coordinates UNIVPM courses in: Biomedical Engineering, Electronics Engineering, Informatics and Automation Engineering, Industrial Management Engineering.

DII promotes excellence in most research areas of the Information Engineering field. Different laboratories participate to the research activity at DII. The following description is related to the research activity of the group headed by Prof. Giuseppe Conte (LabMACS, DOMOLAB, Laboratorio di Automazione) and Prof. Longhi (Laboratorio di Robotica Avanzata). The group is composed of 3 professors and 6 PhD students. About ten students of DII university courses are also involved in CMRE competition on underwater robotics.

Prof. Conte group is focused on Robotics and Mechatronics, Signal processing, Software Engineering, System and Control Theory, Real Time Systems, Automation, Electrical and electronic measurements, Electromagnetism, Electronics, Telecommunications and others. The fields of application are mainly the marine robotics, industrial robotics and domotics.

The research group is a member of ISME, the Interuniversity Center of Integrated Systems for the Marine Environment. ISME has been founded in 1999 with the aim of supporting research activities in the fields of marine technologies and oceanic engineering.

The research activity is financed and performed in collaboration with other national and international centres. In addition, a strong connection with local industries is also at the base of the applied research performed by the group.

Recently, a spin-off of UNIVPM, 3D SuperVision Systems Soc. Coop., was established as a result of the research group activities.

Among the other activities, the group is involved in specific projects on educational robotics in primary schools. The participation to this sort of projects by university researchers is on volunteer base since the products of this activity does not lead to traditional scientific results (eg. publications, patents, etc.). Mechanisms of awards and incentives for researchers and teachers should be offered to facilitate this kind of commitment.

Educational activity

Prof. Davide Scaradozzi (from LabMAC, DII) is involved on a pilot project “ROBOTICA A SCUOLA” at the primary school “Marco Polo” in Rome in collaboration with teacher Marianonietta Valzano. This project aims to develop personal logical ability and creativity, which are the basis of reasoning and critical thinking. The “discipline” of ROBOTICS as a curricular subject is inserted in the usual timetable of matters taught in school.

Pupils study the laws of robotics and learn to design, program and build a robot by using LEGO WeDO and LEGO Mindstorm NXT kits.

Here is the link to the dissemination video of the project:

<http://news.centrodiascolto.it/video/tg2/2012-10-05/istruzione-e-formazione/roma-bambini-progettano-robot-alla-scuola-elementare>

Research

The scientific interests of the group are centered on marine robotics.

Marine Robotics (LabMACS)

The main activity is focused in designing and realizing robotic vehicles and systems for exploration of and intervention in the marine environment. In particular the interest concern the development of automatic navigation, guidance and control systems for unmanned underwater and surface vehicles; sensors and signal processing procedures; actuators and devices for marine applications, 3D documentation and reconstruction.

Applications in the areas of underwater archaeology, marine biology and off-shore industry are currently investigated in the framework of several national and international cooperation.

LabMACS together with ISME and SBAT (Italian Ministry of Culture, Superintendence of Archaeological Goods of Toscana - Soprintendenza per i Beni Archeologici di Toscana) have been working toward automation of the survey process in order to build geo-referenced augmented 3D map of an underwater site during all the phases of the in situ study.

The goal is reached with an integrated system composed by a surface vessel, a bigger ROV for monitoring, a Micro ROV for deeper intervention, USBL acoustic system, and GPS surface positioning.

A sketch of all of that is in Fig. 52.

The equipment and the developments of the Laboratory were able to produce impressive results like the ones shown in Fig. 53.

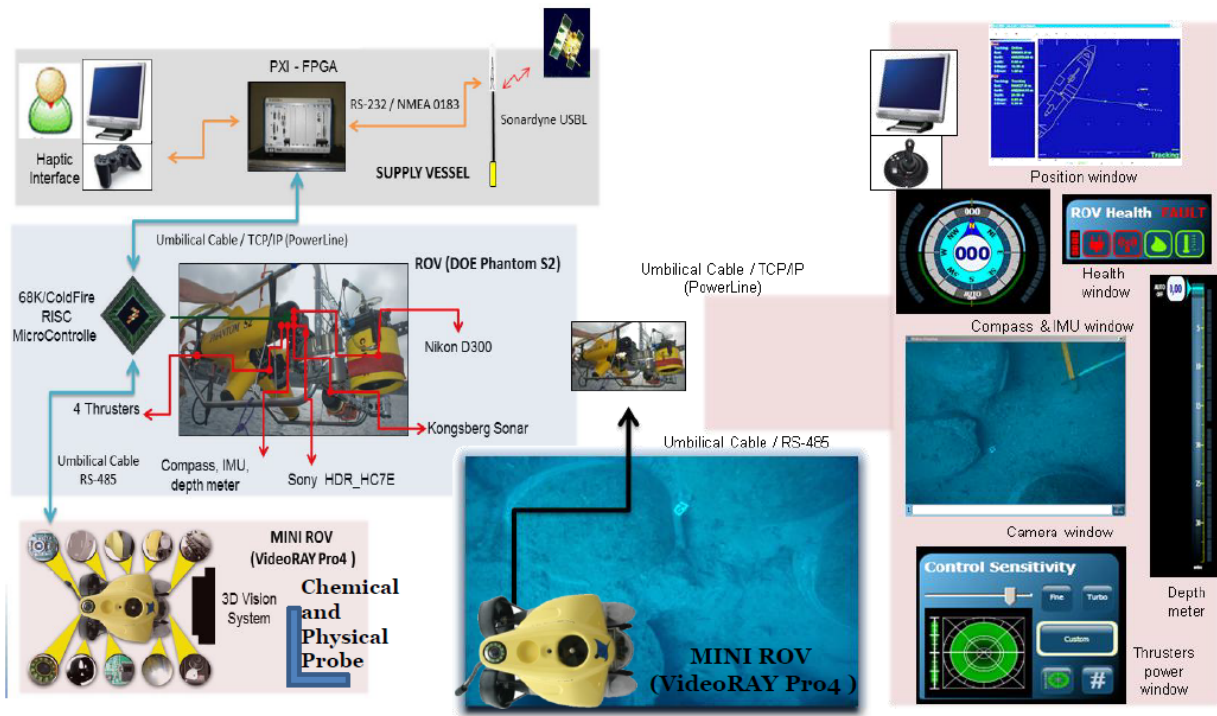

Fig. 52 - LabMACS activity

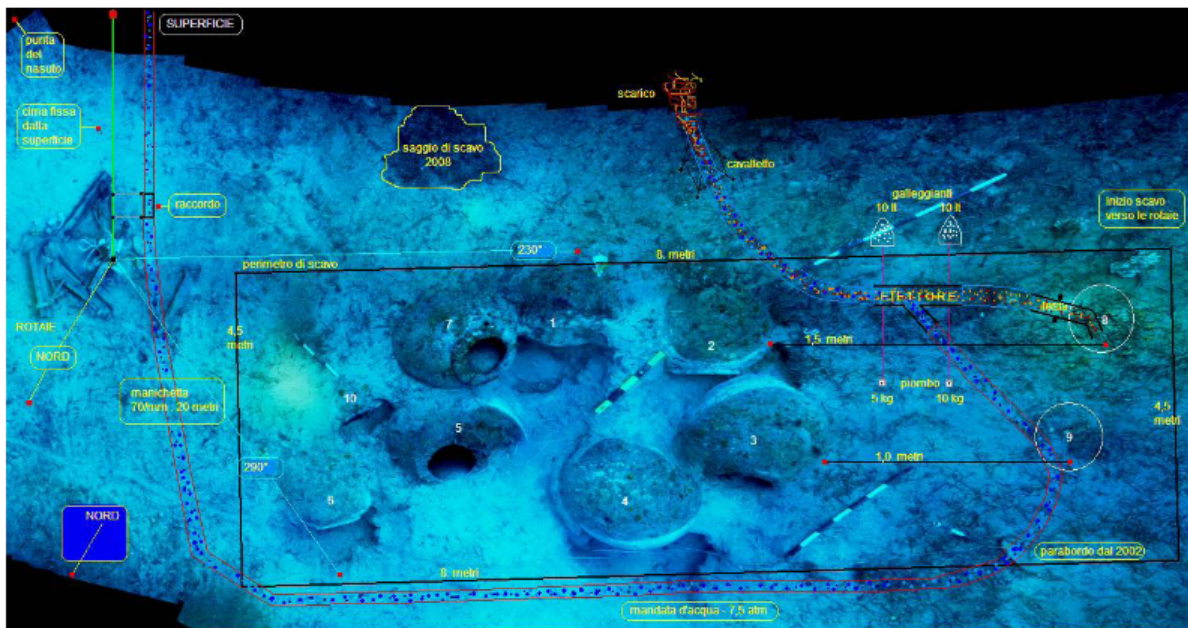

Fig. 53 - Example of 2D Mosaiking: Dolia shipwreck from Elba Island – Italy 50m2 (Courtesy of David Scaradozzi)

Available facilities

- ROVs: Deep Ocean PhantomS2, Prometeo Reloaded, VideoRay Pro4
- High definition 3D cameras, FullHD DV videocamera
- USBL positioning system
- Imaging sonars
- Multiparametric probe for water analysis

Projects

- FP6 European Project NEWTON-Upgrade 2007-2009
- FP6 European Project VENUS - Virtual Exploration of Underwater Archaeological Sites 2008-2010
- FP6 European Project CURE 2009-2011

Home Automation (DOMOLAB)

The research of DOMOLABS aims at developing methodological tools for modeling and controlling home automation systems based on Multiple Agent System Theory and at realizing efficient control strategies for managing limited resources, like electricity, gas, water, in such a way to maximize efficiency and to satisfy user requirements. Related communication issues in home automation systems are also investigated. A complete simulation environment for the design and validation of home automation systems is constructed and related knowledge is transferred to partner industries (ENEL, Indesit Company, National Instruments, Gruppo Bticino-Legrand, Thermowatt, Merloni Termosanitari, AEA).

Projects

- Industria 2015 GEAR

M/M Cooperation in Hyper-flexible Robotic Cells (Automation Laboratory)

It is a research and didactical structure operating mainly in the area of industrial automation. The laboratory's main equipment includes a 6DoF anthropomorphic manipulator, a two finger pneumatic gripper, a flexible work cell installation. The research aims at developing a proximity/contact sensory system, based on E-field sensors, to be installed on an anthropomorphic manipulator in order to allow close cooperation with human operators. Construction of the hardware components, development of the sensory signal processing and integration into the manipulator control system are the main steps in the planned work.

Projects

- National Research Project (PRIN 2007) "Control themes in hyperflexible robotic workcells" 2008-2009
- National Research Project (PRIN 2009) "ROCOCÒ - COoperative and COllaborative RObotics" 2011-2013

Advanced Robotics Laboratory

The Advanced Robotics Laboratory is placed where graduate students carry small research projects in the areas of industrial / assistive robotics and electrical engines control. Equipment is composed of 2 mobile robots, a motorized wheelchair, 2 small helicopters and computing platforms. Fields of application include navigation, guidance and control of mobile robots, robotic systems to support the mobility of persons with reduced capacity, autonomous air robots capable of performing autonomous operation of surveillance and control, intelligent driving support vehicles with low impact environmental, vision systems support to quality control in

manufacturing processes and manufacturing, control systems to support the board comfort in mega yachts

Projects

- R3Cop. EU and ARTEMIS project. 26 partners with a strong industrial presence. The aim is to provide European industry with new leading-edge innovation that will enable the production of advanced robust and safe cognitive, reasoning autonomous and co-operative robotic systems at reduced cost.

Publications

Conte G., Scaradozzi D., Donnini R., Pedale A. Building simulation/emulation environments for home automation systems, 19TH MEDITERRANEAN CONFERENCE ON CONTROL AND AUTOMATION, MED 2011.

E.Lanciotti, G. Conte, D. Iacobucci, L'attuale livello di diffusione dell'automazione nel distretto calzaturiero fermano-maceratese, ECONOMIA MARCHE, Vol. supplemento al n. 2 /2009, 2010.

Conte G; Morganti G; Perdon A.M; D. Scaradozzi, Multi-Agent System Theory for Modelling a Home Automation System, Journal Of Physical Agents, Vol. 3, 2009.

Conte G., Zanolì S.M., Scaradozzi D., Caiti A., Robotics techniques for data acquisition in underwater archaeology, International Journal Of Mechanics And Control, Vol 10, 2008.

Conte G., Gambella L., Scaradozzi D., Zanolì S.M., Caiti A., Calabrò V., Alcocer A., Alves J., Cardeira B., Cunha R., Curado F., Oliveira P., Oliveira A., Pascoal A., Rufino M., Sebastião L., Silvestre C, Underwater Vehicle Technology in the VENUS project, Underwater Technology, Vol. 4, 2009.

P. Drap; J. Seinturier; G. Conte; A. Caiti; D. Scaradozzi; S. Zanolì; P. Gambogi, Underwater cartography for archaeology in the VENUS project, Geomatica, Vol 62, 2008.

Caiti A; Conte G; Casalino G; S. Zanolì, Innovative technologies in underwater archeology:field experience, open problems and research lines, Chemistry In Ecology, Vol. 22 (supplement 1) 2006.

E. Frontoni; A. Mancini; A. Ascani; P. Zingaretti; S. Longhi, A Visual Global Positioning System for Unmanned Aerial Vehicles Used in Photogrammetric Applications, Journal Of Intelligent & Robotic Systems, Vol. 61, 2011.



DIEI – University of Perugia

DII: Summary Table	
Institute	DIEI - University of Perugia, SIRALAB Via Goffredo Duranti 06125 PERUGIA
Year of foundation	2001
Reference person	Prof. Paolo Valigi (valigi@diei.unipg.it)
Website	http://www.sira.diei.unipg.it/
Scientific Areas	Aerial and Underwater Robotics, Perception in Robotics. Medical and biological research
Robotic Applications	Robotics for hostile environments, Medical applications, Industrial Applications, Smart Cities
Scientific Expertise	Informatics, Artificial Vision Signal Processing Control Theory Mechanical Design
Team size	10
Senior researchers	6

Introduction

The SIRALab group of University of Perugia – DIEI department – is a young group that proved to be highly dynamic and enthusiastic on many of the most advanced fields of robotics. A large interest is concentrated on the cooperation with the territory production firms.

The DIEI Department of University of Perugia is part of a network of enterprises working on the Umbria area especially interested in the development of their technological capability. The main reference in this line is perhaps “Umbria Innovazione” a public-private partnership with the aim to promote and actuate high technologies developments, technology transfer, high tech services for public users, research activities and to enhance the competitiveness of the whole regional industrial sector.

Research

The main focus of the SIRALAB group of Perugia University is historically in the development of control systems for the mobile robotics. Along this line the group worked for many years with the robotics laboratory of ENEA Casaccia participating to many large projects (we can mention here the PRASSI project funded by the Ministry of Research and the Harness project) and developed significant testing devices, sensors and vehicles. The expertise of the Lab was built in many years also in the control of flying vehicles, especially multicopters, and the laboratory also produced an industrial spin-off that is still operating on the market also at international level. Recently the attention of the group moved towards the application of advanced techniques of artificial vision to the guidance of autonomous vehicles, recognising areas where the unit is already passed in order to reconstruct a map of the environment, especially in indoor environments.

Similar methodologies have been realised for different vision layers, like the detection of unexpected events in dynamic scenes (i.e. anti terrorism security measures) or the estimation of movements of the camera with respect to patterned surfaces to allow an affordable guidance of vehicles without any other possibility of self-localisation (underwater vehicles).

Cooperations

Apart the aforementioned cooperation with ENEA, the DIEI group of Perugia is strongly engaged with the support to the Umbria Innovazione organization where the Prof. Valigi, leader of LiraLab is also a full member of the scientific council.

In addition DIEI is strongly cooperating with Università Politecnica delle Marche and is evaluating its engagement in the ISME Interuniversity association.

Publications

F. Bianconi et al.. "SYSTEMS BIOLOGY IN TRANSLATIONAL ONCOLOGY: COMPUTATIONAL AND EXPERIMENTAL STUDY OF EGFR AND IGF1R PATHWAYS IN NSCLC CELL LINES". *Annals of Oncology*. 2012.

T. Ciarfuglia, G. Costante, P. Valigi and E. Ricci. "A Discriminative Approach for Appearance Based Loop Closing". *International Conference on Intelligent Robots and Systems (IROS)*. 2012. [\[Online version\]](#)

A. Ragnacci, M. Pastorelli, P. Valigi and E. Ricci. "Exploiting dimensionality reduction techniques for photovoltaic power forecasting". *ENERGYCON*. 2012.

L. Bissi, G. Baruffa, P. Placidi, E. Ricci, A. Scorzoni and P. Valigi. "Patch based yarn defect detection using Gabor filters". *IEEE International Instrumentation and Measurement Technology Conference*. 2012.

M. Tiribuzi, M. Pastorelli, P. Valigi and E. Ricci. "A Multiple Kernel Learning Framework for Detecting Altered Fingerprints". *International Conference on Pattern Recognition (ICPR)*. 2012.

F. Bianconi, V. Brunori, P. Valigi, F. La Rosa and F. Stracci. "Information technology as tools for Cancer Registry and Regional Cancer Network integration", *IEEE TRANSACTIONS ON SYSTEMS MAN AND CYBERNETICS PART A-SYSTEMS AND HUMANS*. 2011.

A. Alessandretti, A. Pedro Aguiar, . Joao P. Hespanha and P. Valigi. "A Minimum Energy Solution to Monocular Simultaneous Localization and Mapping". *50th IEEE Conference on Decision and Control and European Control Conference*. 2011.

F. Bianconi, E. Baldelli, V. Ludovini, L. Crinò, A. Flacco and P. Valigi. "Computational model of EGFR and IGF1R pathways in lung cancer: a Systems Biology approach for Translational Oncology", *Biotechnology Advances*, Vol. Accepted. 2011.

F. Bianconi, L. Gabriele and P. Valigi. "Dynamic modeling and parameter identification for biological networks: application to the DNA damage and repair processes". L. L. A., W. D. and L. Y. EDS eds. Shanghai : Limin Angela Liu, Dongqing Wei, and Yixue Li Eds. 2011. [\[Online version\]](#)

B. G, F. M, A. Ficola, S. Pagnottelli and P. Valigi. "A Mini UAV for security environmental monitoring and surveillance: telemetry data analysis". Workshop on Mini and Micro UAV for Security and Surveillance. 2008.

L. G and P. Valigi. "State estimation for a model of gene expression". *International Conference on Systems and Circuits*. 2008. pp. 2046-2049. [\[Online version\]](#)

H. Axelsson, M. Boccadoro, M. Egerstedt, P. Valigi and Y. Wardi. "Optimal Mode-Switching for Hybrid Systems with Varying Initial States", *NONLINEAR ANALYSIS*, Vol. 2. 2008, pp. 765-772.

M. Boccadoro, F. Martinelli and P. Valigi. "A multi agent control scheme for a Supply Chain model", *ASIAN JOURNAL OF CONTROL*, Vol. 10. 2008, pp. 260-266.

M. Boccadoro, F. Martinelli and P. Valigi. "Supply Chain management by H-infinity control", *IEEE TRANSACTIONS ON AUTOMATION SCIENCE AND ENGINEERING*, Vol. 5. 2008, pp. 703-707.

L. Adacher, M. Boccadoro, F. Martinelli and P. Valigi. "Cooperative and competitive negotiation in a Supply Chain model". *47th IEEE Conference on Decision and Control (CDC '08)*. 2008.

ROME

One of the largest areas of research, industry and education in robotics

As already introduced, Rome has been considered as an area self-standing because of its considerable number of academies and research centers. In fact, among public, private and specialized Universities Rome can exhibit not less than nine large or medium size Universities at different levels; we remember here Sapienza (perhaps the largest Academy in Europe in term of number of students), Roma Tor Vergata, Roma TRE, Campus Biomedico, LUISS, LUMSA, European University of Rome, Catholic University of Sacro Cuore, University of Foro Italico and many others with a limited number of students up to the considerable number of about 30 Academic Institutions.

In addition Rome and its surrounding area host the central headquarters of CNR, the major Italian research institute, with many of its institutes and of ENEA, the second one.

Tiburtina area is also the hearth of most of the prominent Italian industries in the military, security and electronic fields and also many SMEs are also grown in the immediate vicinities of the Capital owing to the advantages offered by the simultaneous presence of Large Industry, high level Universities, Research Centers and public administration.

At least four of the major Academies have inside important groups working in the robotics field with many international level professor; in addition another historical significant group is in ENEA and others can be found within the many Finmeccanica industries.

ENEA: UTTEI Rob

THE ENEA 's ROBOTICS LABORATORY

ROB: Summary Table	
Institute	ENEA Casaccia Research Center Via Anguillarese 301, Rome
Year of foundation	1961
Reference person	Claudio Moriconi claudio.moriconi@enea.it
Website	http://robotica.casaccia.enea.it/
Scientific Areas	Man-machine interface Artificial intelligence Distributed Robotic Systems Underwater Robotics Sensors and perception Biorobotics Mechatronics
Robotic Applications	Assistive Robotics Robotics for hostile environments Service robotics
Scientific Expertise	Mechanical Design Systems engineering and electronic design Informatics Signal processing Control theory
Team size	20
Senior researchers	12

Introduction

ENEA (Italian National Agency for New Technologies, Energy and Sustainable Economic Development) is a public organization operating in the fields of energy, the environment and new technologies. It has currently more than 2700 staff members distributed all over Italy, from Rome headquarters to 12 main research centers mostly dedicated to Research and Technology Development, transfer and dissemination.

ENEA involvement in Robotics dates back to the early years of the Italian nuclear program and is closely connected to the need for telemanipulation of highly radioactive substances. The Robotics Laboratory of ENEA, located in Casaccia (Rome) is active since 1961, with the design and realization of the first tele-operator in Europe for Nuclear Fuel management (Mascot 1). (See Fig. 54 and Fig. 55).

This makes ENEA the first Italian operator in robotics field.

Within the years, the laboratory widened its activity by developing control systems and sensing equipment for many robot systems including mobile surveillance robots, industrial special robots, advanced sensing devices (see Fig. 56 and Fig. 58).

Since 1996 the Laboratory started up an activity line on underwater robotics and developed, together with the Italian firm Tecnomare, the robot SARA (see Fig. 57), a large underwater robot tested in the Antarctica waters and intended especially for the monitoring of the sea bottom around the Italian base of Terranova (now Mario Zucchelli base).

Many other robotics applications have been developed since then including, as reported in the following, buoys, MMI for underwater vehicles, special vehicles.

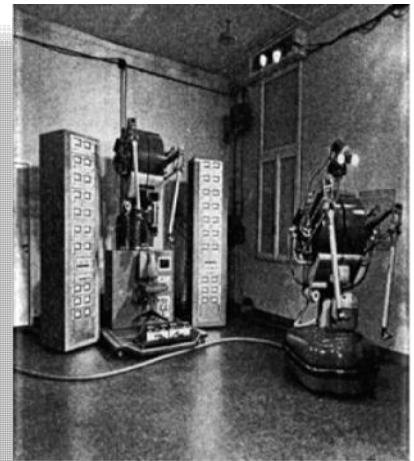

Fig. 54 - Mascot telemanipulator



Fig. 55 - Mascot 4 telemanipulator at La Villette - Paris



Fig. 57 - SARA (on the top and aside): the first “Sottomarino Antartico” Robotizzato” at ENEA



Fig. 56 - A detail of the Antarctica Surface Robot (RAS)

In 2008, the Laboratory launched the innovative concept of the “self-organising complex creatures”, based on the swarm paradigm, but aimed at overcoming the most serious AUV problem, the very limited capability of communication with a human supervisor from underwater. Harness project, funded by the IIT (Italian Institute of Technology), is the first result of this concept and the VENUS parallel project, entirely funded by ENEA, is the direct investment of the RTO on this line. Together with ENEA, University of Tor Vergata and University of Perugia joined into the development of the complex project that has achieved the interest of many national end-users and many large industries.

Educational activity

The mission of ENEA does not include direct educational aspects, like lessons at the Universities. However, the robotics group was active since the beginning with traditional exploitation of master thesis supported by unit projects, and external grant. Postdoc courses on robotics have also been held during the development of the projects.

Moreover, ENEA, as part of its institutional role, promotes the dissemination of knowledge acquired through its research activities. It can boast many and positive contact experiences with schools, like the ‘initiative “EneaScuola” born to support the dissemination of scientific and technological culture; this was achieved by seminars on various scientific topics for pupils in schools. On the same way also the project “Educarsi al futuro.” was concerning the pupils training to the scientific research. An agreement with the Institute ITIS Fermi in Rome, based on the main topics of Robotics and Energy, was signed with the aim to introduce these themes in the world of secondary school, in order to train the younger generation. ENEA is also a member of the association Italian network of robotics (ref. to the Mondo Digitale always in the Rome Area) and appointed in the board direction of the association.

Research

The Robotics Unit of ENEA has moved its interest towards the technologies of advanced control and intelligent perception. The technological and scientific interests actually follow four main tracks whose latest results are in the following summarized.

Land mobile robotics

Many research projects have been carried out in the field of autonomous land mobile robots for surveillance and security goals, cultural heritage preservation and elderly people care (RAS, PRASSI projects, see Fig. 56 and Fig. 58, TECSIS project). In this frame have been developed algorithms for autonomous navigation, artificial vision pattern recognition and robot cooperation.

Underwater and aerial mobile robotics

A swarm of autonomous underwater vehicles targeted to communications and security applications is currently under development (Harness project and the parallel activity of the VENUS vehicle development, see Fig. 59 - The VENUS AUV). The key points are: a distributed



Fig. 58 - PRASSI Surveillance robot



Fig. 59 - The VENUS AUV

control system, new communication strategies and the design of a submarine prototype. The simultaneous control of several independent UAV's concurring in the same aerial space in order to avoid possible conflicts among themselves and with commercial aircrafts is the subject of the Eurostars ARCA project. The subject is tackled using Cooperative Game Theory.

Teleoperation and telemanipulation and Human-machine interfaces

WiRo6.3 is a new control device for the interaction with virtual reality environments and for telemanipulation tasks, with force feedback capabilities. It is a six DoF mechanical device characterized by the actuation of a mobile platform by nine wires. Recently it has also been employed as a stabilized carrier for precision measurements apparatus.

Sensorial systems

“Artificial skin” is a sensorial system able to transmit to the operator human skin sensation. TESSA is a Hi resolution stereoscopic underwater visual sensorial system aimed at 3D visual reconstruction of submerged objects.

Funded projects

TINA, Telepresence Interface Architecture, funded by Ministry of Research - development of a multimedial architecture for robot supervision.

TECSIS: Diagnostic technologies and intelligent systems for the development of the archaeological sites of Southern Italy - funded by the Ministry of research on the PON and led by ENEA allowed the development of a number of technologies for the diagnostics, the maintenance and the fruition of the cultural heritage. Many developments, including underwater robotics and sensing technologies have been addressed and realized: in Fig. 61 experimental equipment for an ultrasonic underwater camera and in Fig. 60 it is shown a stereoscopic camera for undersea archeological goods.



Fig. 60 - TESSA: Stereoscopic camera for undersea archeological use



Fig. 61 - STSS500 Ultrasonic stereoscopic 3D camera



Fig. 62 - Example of cooperative robots

For the exploration of remote sites forms of cooperation of more robots have been also studied (Fig. 62).

PRASSI: Autonomous robotic platform for security and surveillance of industrial plants - funded by Ministry of Research, Study and Development of a fully autonomous terrestrial mobile surveyor.

MIAO: Microsystems for hostile environments; Funded by MIUR was aimed at the development of microtechnologies for hostile environments among these the study of intelligent functions for feeling classification from the perception of an artificial skin.

Projects more specifically oriented to the field of underwater Robotics:

SARA, Antarctica Robotized Autonomous Submarine (see annexed picture) - design, realisation, control and demonstration of a large underwater vehicle torpedo shaped for the exploration and monitoring of Antarctica underwater basement – funded by the he University and Research Ministry.



Fig. 63 - PANDORA a subglacial navigation robot designed by ENEA for Antarctica national program- tests on alpine glaciers

PANDORA, Ice drilling and navigation for Antarctica sub ice lakes - conceived and carried out as a preliminary investigation to allow a submersible vehicle to navigate in the Antarctica lakes encapsulated under thousands of meters of ices in centre of the Plateau it has been funded mainly by ENEA's funds (Fig. 63).

ARAMIS - MAS3 (Marine Science and technology) European project aimed at the development of submersible compact intelligent sensing units.

BOMA, automated buoy for environmental monitoring; ENEA has been involved especially for the aspects of intelligent control of the underwater asset.

MELBA, Automated buoy for environmental monitoring along sea currents; ENEA has been involved especially for the aspects of intelligent control of the underwater asset.

SAM, autonomous submarine for the Mediterranean sea - Study, design and realisation of AUV for deep areas of Mediterranean Sea. Funded by the Ministry of Research.

STSS-500, underwater acoustic camera. Development of a smart interface to allow a human operator to effectively perceive acoustical images in shallow water also in condition of fuzzy images. Special care has been devoted to the aspects of human factors trying to present the information flow to the brain in order to exploit at best its peculiar abilities together with artificial recognition (moving objects recognition, artificial classification of sounding patterns). Funded by Ministry of Research.

HARNES (Human telecontrolled Adaptive Robotic Network of SensorS) deals with a multipurpose underwater robotic swarm, the HARNES project (Human telecontrolled Adaptive Robotic Network of SensorS) currently in progress in our laboratory. This system is based on cheap autonomous underwater vehicles (AUV) organized with swarm rules and conceived to perform tasks, ranging from environmental monitoring to terrorism attack surveillance (Fig. 64).

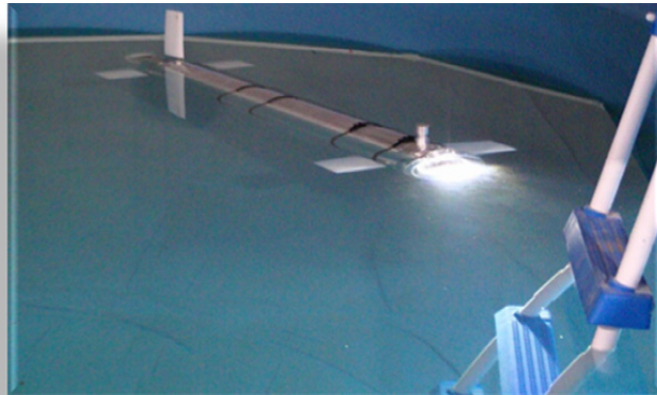

Fig. 64 - Venus during test in pool

Available facilities

- Laboratory Pool for submersible swarm test, 6 by 8 meters with limited depth (1.4 mt) has been realized to test algorithms and devices.
- Brasimone lake – A big facility located not far from Bologna and managed by ENEL that has the property of the lake itself: Brasimone is a closed lake with one of the greater ENEA's centers disposed around it. An agreement to perform robotic campaigns with demanding features has been already consolidated with the Centre authorities and the final campaign of the recent STSS-500 project has been carried out in that site.
- Tigershark swarm (6 elements) - a simple and cheap underwater vehicle to test the behavior of small - medium size underwater swarms.
- Simulation platform for basic skull navigators. A simple simulation platform realized during a self-funded preparation phase of the project.
- SARA (Submarine for Antarctica Robot Autonomous) a 5 meter. long AUV torpedo shaped designed and realized by an Italian team headed by ENEA, able to navigate down to 1000 m from the surface
- Falcon - ROV for test campaign assistance in lakes or seas. It is a very powerful, easy to use underwater skull able to survey, deploy, recover other underwater devices. It could be endowed also with manipulating capabilities.
- UGV of various dimensions.
- Inflatable boat for underwater test campaigns. Especially useful for lake operation.

Publications

C. Moriconi, R.dell'Erba, ENEA, - "HARNESS: A Robotic Swarm for Harbour Security", Italy Port and Regional Maritime Security Symposium Lerici (SP), Italy, 21-23 May 2012



M.Caponero, A. Aliverdiev, C. Moriconi, - "Some Discussions on the development of a Speckle-Velocimeter", Russian Journal of Technical Physics, vol. 48, n.11-2003

M.Caponero, A. Aliverdiev, C. Moriconi, - "Speckle Velocimeter for a Self-Powered Vehicle", Russian Journal of Technical Physics, vol. 47, n.08-2002



C. Moriconi, "Human and artificial intelligent beings: reasoning on a cultural approach", IARP International Tsukuba Workshop, 8 December 2002

Stefano Chiesa, Sergio Taraglio – "A Novel Genetic Approach To Epipolar Geometry Estimation" - 376-381, IPCIPVC V IPVC 2010: Las Vegas, Nevada, USA

C. Moriconi, R. dell'Erba - "Social Dependability: a proposed evolution for future Robotics," Sixth IARP-IEEE/RAS - EURON Joint Workshop on Technical Challenges for Dependable Robots in Human Environments May 17-18, 2008, Pasadena, California



C. Moriconi, R. dell'Erba, - Harness: A robotic swarm for environmental surveillance ENEA 6th IARP RISE2012 the 11-13 of September in Warsaw

Claudio Moriconi e Ramiro dell'Erba – "The Localization Problem for Harness: a Multipurpose Robotic Swarm" The Sixth International Conference on Sensor Technologies and Applications SENSORCOMM 2012 August 19 - 24, 2012 - Rome, Italy

D. Taurino, S. Taraglio, A. Tedeschi, A. Pasquini, V. Nanni, "Increasing the Autonomy of Unmanned Aircraft Vehicles with a Game Theory Approach", Proceeding ICIUS-2010 International Conference on "Intelligent Unmanned Systems", Bali, Indonesia, 3-5 Novembre, 2010



D. Taurino, A. Tedeschi, A. Sánchez, A. Flores, R. Sysala, P. Suchánek, V. Nanni, S. Taraglio, "Adaptive Routing and Conflict Management for Unmanned Aircraft Vehicles", Proceeding 15th IASTED-RA 2010 International Conference on "Robotics and Applications", Cambridge, Massachusetts, USA, 1-3 Novembre, 2010

D. Taurino, S. Taraglio, A. Tedeschi, A. Pasquini, V. Nanni, "Satisficing Game Theory for Enhancing Autonomy in Unmanned Aerial Vehicles", IJAI-International Journal of Artificial Intelligence, Volume 7, Number A11, Autumn (October), 2011

S. Bossi, S. Kammer, T. Dörge, A. Menciassi, K.P. Hoffmann, S. Micera, "An implantable microactuated intrafascicular electrode for peripheral nerves", IEEE transactions on biomedical engineering, Volume 56, N° 11, pp. 2701-2706. 2009.



S. Bossi, A. Menciassi, K.P. Koch, K.P. Hoffmann, K. Yoshida, P. Dario, S. Micera, "Shape Memory Alloy Microactuation of tf-LIFEs: Preliminary Results", IEEE Transaction on Biomedical Engineering, Volume 54, N° 6, pp. 1115-1120. June 2007.

S. Bossi, S. Kammer, T. Doerge, A. Menciassi, K.P. Hoffmann, S. Micera, "Prototype development of an actuated intraneural electrode". IFESS 2008-From Movement to Mind, 13th Annual International FES Society Conference. Friburgo, Germania, 21 – 25 settembre, 2008.

Finmeccanica

ALENIA: Summary Table	
	
Institute	Alenia
Year of foundation	1948
Reference person	Bruno Tranchero bruno.tranchero@alenia.it
Website	http://finmeccanica.it/
Scientific Areas	Automation, Artificial Intelligence, Robotics
Robotic Applications	Security, Military Applications, Satellite management, Remote operation, Support to Naval researches
Scientific Expertise	Electronic Design, Mechanical Design, Computing, Man Machine Interface, Human Robot Interface, Remote Control, Sensor based control
Team size Senior researchers	Not Available. The presentation include the abilities and the potential of many industries of the group

Finmeccanica is a different player with respect to all the others mentioned in this report, not only because of its peculiar robotics market, mainly oriented to Aerospace, Defence and Security segments, but also because if its presence in robotics is part of the Group strategy, it is largely in the controlled companies that it is carried on.

As an example they recently developed, as a Group, a global robotics simulator, integrating all the simulators independently developed by each company. This “Group” product is able to generate a convincing demonstration environment used to represent to the possible customers the potential of the product of interest in the frame of a more general context, where many defense systems are simulated together.

On the other hand, the automation technologies developed by each company are not mutually dependant, so that each of them develops its own solutions and strategies for its peculiar products.

Robotics is also one the big themes of MindSh@re, the Finmeccanica community that represent a viewpoint of the technological and scientific developments in the group and of the research organizations and academies connected in many different initiatives with the group companies.

Again, as a group, Finmeccanica recently started up a new MindSh@re Autonomous Systems (robotics) Community, joining representatives of each company of the Group, to envisage a sort of “coordinated” development and strategy. Not a hierarchical organization then, but more likely a structured working group of technical strategies.

Finmeccanica is an international holding currently owned for about the 30% of its capital by the Italian Government and includes national and foreign companies, but the main firms involved in robotics and significantly located in Italy are:

- Alenia Aermacchi
- Agusta Westland
- Whitehead Sistemi Subacquei (WASS)
- Oto Melara
- MBDA (a joint venture)
- Selex ES
- Sistemi Software Integrati (SSI)
- Thales Alenia Space (a joint venture)
- Telespazio (a joint venture).

Due to this very articulated situation the report will address mainly the key elements of Finmeccanica presence in robotics, reporting the main development lines and some of the most important realizations. It has anyway to be remembered that the Finmeccanica companies also have in place alliances with national and international industrial players, academies and RTOs.

Robots, or autonomous systems, are not to be viewed as a humanoid-like entity in Finmeccanica. They are more often intelligent and autonomous entities that can range by unembodied software collecting data by a distributed sensing network and giving back information and a general situational awareness, to software components of a more complex and articulated robotic system (as in the case of SSI, i.e. software platform for real-time cooperating multi-robot systems), to unmanned aircraft systems (UAS, ranging from tactical to MALE to UCAV), grounded (UGV), marine platforms (including AUV) or space rovers.

In addition there is also to point out that the final products are often result of a cooperation not only inside the Group, but also with other national and international players. Nevertheless, some of the most advanced robotics topics like the problems relevant to AI, the independence by the human directives or the “ethic” behavior in real life situations are investigated in the research programs of many companies of the Group.

This part of the report has been produced by courtesy and with the cooperation of the Autonomous Systems Community of the Finmeccanica Group.



Fig. 65 - A. Sky-Y: MALE demonstrator developed by Alenia Aermacchi; B. Selex ES: Falco tactical UAV; C. WASS: Autonomous Underwater Vehicle Dexarm, developed by a Team led by Selex ES for Space Missions; D. Thales Alenia Space Italia: Space rover demonstrator developed by STEPS Research Project a project co-financed by Regione Piemonte from EC Platform: POR FESR - 2007/2013; E. Dexarm, developed by a Team led by Selex ES for Space Missions

DIAG – Sapienza, University of Rome

DIAG: Summary Table	
Institute	University of Rome “Sapienza”, Via Ariosto 25, 00185, Rome
Year of foundation	1983
Reference person	Prof. Daniele Nardi (nardi@dis.uniroma1.it) Prof. Fiora Pirri (pirri@dis.uniroma1.it) Prof. Alessandro De Luca (deluca@dis.uniroma1.it)
Website	http://www.dis.uniroma1.it/ ALCOR - Cognitive Robotics Laboratory: www.dis.uniroma1.it/~alcor Robotics Laboratory: www.dis.uniroma1.it/labrob RoCoCo - Cognitive Robot Teams Laboratory: www.labrococo.dis.uniroma1.it
Scientific Areas	Man-machine interface, Artificial intelligence, Humanoid Robotics, Distributed Robotic Systems, Sensors and perception, Motion Planning, Sensor-Based Control
Robotic Applications	Mobile robotics (ground, aeronautics, marine); Surveillance and Security; Domestic robotics (Cleaning home and home automation); Service robotics; Industrial robotics
Scientific Expertise	Informatics; Signal Processing; Control Theory; Systems engineering and electronic design
Team size	30
Senior researchers	11

Introduction

DIAG, the Department of Computer, Control, and Management Engineering Antonio Ruberti at Sapienza University of Rome (former DIS), has been at the forefront of research in control theory, computing science and operations research since its foundation. It was established by Antonio Ruberti, scientist, Rector of Sapienza and then Minister of University and Scientific Research, and the European Commissioner for policy research, education, training and youth.

The whole department has more than 70 professors and senior researchers and about 100 PhD students and Post-Doc researchers.

Its mission concerns of teaching and research in engineering areas in particular in the fields of automatic engineering, management, information technology, and of biomedical engineering, clinical and information.

Three different DIAG laboratories have been reviewed in this work as mainly related to robotics area: Lab Ro.Co.Co., Alcor and Labrob.

Lab Ro.Co.Co

The laboratory is focused on Cognitive Robotics and Artificial Intelligence and multi-agent and multi-robot system. It participates in the RoboCup competitions since 1998. The application domains of Lab Ro.Co.Co include virtual agents in search and rescue simulation, multi-robot systems in soccer, search and rescue, surveillance and domotics.

New robotic facilities of the groups include: [NAO](#) humanoid robots by Aldebaran, mini UAVs deployable in search and rescue operations, and traditional wheeled platforms.

The team is composed of 12 members (4 of which are Professors) under the guide of Prof. Nardi. The team is composed of young and passionate scientists involved in several national and international projects.

The scientific interests of the group includes:

- **Mobile robot navigation:** Simultaneous localization and mapping (SLAM), localization and path planning for wheeled and flying robots.
- **Cognitive Robotics and Planning:** Logic-based planning systems with sensing actions, Planning with incomplete information, sensing and uncertainty, Plan representation formalism for robot and multi-robot based on Petri nets.
- **Multi-Robot Coordination:** Autonomous robot soccer players in RoboCup Middle-Size League, Four-Legged and Standard Humanoid League, Multi-robot systems for assistance of elderly people.
- **Multi-Agent and Multi-Robot Systems for Rescue Operations:** Multi-agent systems for simulating search and rescue operations in large-scale disasters, development of a multi-robot system for search and rescue operations, development of a micro UAV for information gathering in surveillance and search and rescue.
- **Stereo Vision Systems:** Multiresolution Stereo Video, 3D environmental modelling, people localization and tracking
- **Video-Surveillance Systems:** ARGOS (Venice) a video-surveillance system for Venice Grand Canals
- **Steganography:** ISC steganographic developed for embedding messages into JPEG images.



Fig. 66 - Research products of Lab Ro.Co.Co.

ALCOR Lab

ALCOR has been established in 1998. The team, composed of 8 members with 4 PhD students, is under the guide of Prof. Fiora Pirri. The group work on improvement of recognition process by 3D reconstruction, people facial expression interpretation, motion interpretation, shape analysis, bottom-up attention in audio-visual scenes, natural images for visual localization, probabilistic and logical models of actions prediction. Most of the experiments use the Gaze machine, a device in progressive development. The research activity focuses mainly on:

- **Vision and Perception:** The research activities in this area include Visual Search, Attention, Human Action Recognition, X-SAR images classification.
- **Planning and Cognitive Robotics:** It concerns theories of Actions, Flexible Temporal Planning, Task Switching, Flexible Reasoning, Multimodal HRI.

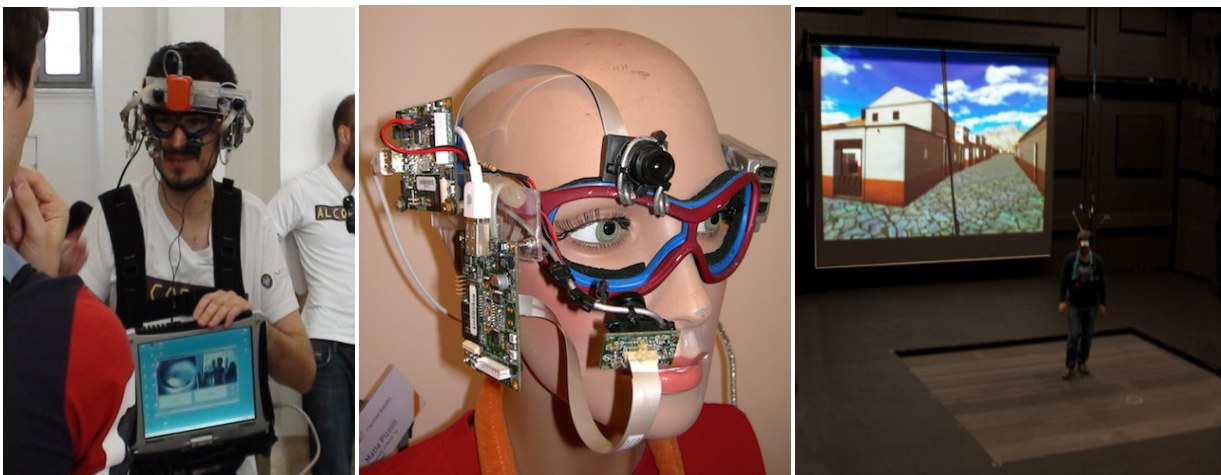

Fig. 67 - Eye tracker and Gaze machine for experiments on visual localization and recognition and Smooth re-centering motion control of the 2D CyberWalk treadmill for unconstrained natural walking of users immersed in VR environments

The facilities of the laboratories include:

- VICON MX. An advanced optical motion capture system composed of 10 cameras and controlling hardware module. The VICON system is provided by GPEM Srl.
- TALOS. It is a mobile robot with two tracked bogies at the sides and four active tracked flippers placed at the front and rear, that endow it with increased mobility in rough terrain. It is equipped with a rotating 2D SICK LMS-100 Laser, a Ladybug3 Omnidirectional camera, an inertia measurement unit (IMU) from Xsense, GPS and an on-board quad-core computer.
- GAZE MACHINE is a wearable device that identifies the gaze scan path of the person wearing it, in the environment.
- SECURO Agent (SHRIMP) Bluebotics ShrimpIII mechanical architecture provides the robot with an incredible mobility. It is able to easily move in very challenging terrain, overcome vertical obstacles of twice its wheel size, and it can even climb stairs. The additional payload is composed by a light laptop, sensor for localization (inertial platform Crossbow) and for image acquisition (two firewire cameras PtGrey Flea), a pack of Li-Ion battery, communication (Bluetooth and Wireless 802.11a).
- DORO Agent1 (Pioneer 3DX)
- DORO Agent2 (Pioneer P3-AT). ActivMedia PIONEER 3-DX is mobile robotic platform agile and able to carry loads robustly and to traverse sills, with high-performance management to provide power whenever it is needed. It is endowed with: a mobile head with a couple of stereo cameras provided by Allied Vision Technologies Marlin, an inertial platform Xsens MT9 for localization, eight sonars ring Polaroid and a laser DISTO Leica. The value of the robot includes purposely developed software for localization, map reconstruction, communication and planning, navigation and recognition.



Fig. 68 - (Left) The TALOS mobile robot in field operation after the earthquake in Mirandola, and Social robots for Smart Monitoring of Complex Public Scenes (center and left)

ROBOTICS Lab

The Robotics lab was established in the late 1980s with a commitment to develop innovative methods for modeling, planning and control of industrial and service robots. Over the years, remarkable research results were obtained in such area. In addition, recent activities include control and visual servoing for unmanned aerial vehicles (UAV), motion planning and control of locomotion in humanoid robots, and sensory supervision of human-robot interaction.

The principal disciplines of research are described below:

- **Planning and Control of Humanoid Robots:** [Vision-Based Odometric Localization for Humanoids using a Kinematic EKF](#); [Vision-Based Corridor Navigation for Humanoid Robots](#)
- **Motion Planning:** [Planning Safe Cyclic Motions under Repetitive Task Constraints](#); [A Control-Based Approach for Task-Constrained Motion Planning](#)
- **Nonholonomic Mobile Manipulators:** [Kinematic Control](#); [Image-Based Visual Servoing Schemes](#)
- **Multi-Robot Systems:** [Mutual Localization with Anonymous Measurements](#); [Distributed Target Localization and Encirclement](#); [Exploration of Unknown Environments](#)
- **Robotic Exploration of Unknown Environments:** [With Mobile Robots: The SRT Method](#); [With General Robotic Systems: Sensor-based Exploration Trees](#)
- **Modeling, planning and control of Unmanned Aerial Vehicles (UAVs):** [Vision-Based Loitering over a Target for a Fixed-Wing UAV](#); Modeling and Control of an Autonomous Paraglider
- **Physical Human-Robot Interaction:** [The SICURA project](#) (funded by MIUR, PRIN); [The PHRIENDS project](#) (funded by EU, STREP)
- **Visual Servoing:** [On-Line 3D structure and Focal Length Estimation](#); [Following paths with nonholonomic mobile robots](#); [Comparing appearance-based controllers for nonholonomic navigation from a visual memory](#).

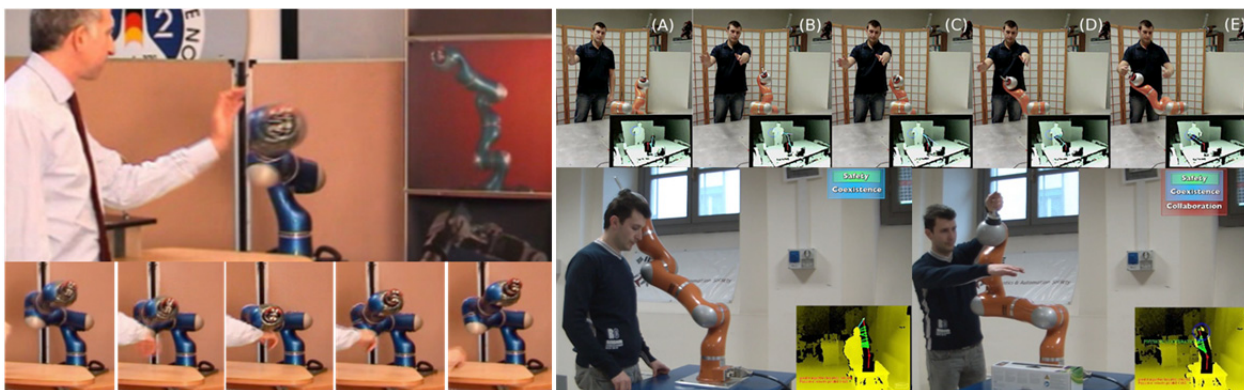

Fig. 69 - (Left) Sensor-less collision detection and robot automatic safe reaction (PHRIENDS), (right) Collision avoidance using a depth sensor, safe coexistence, and human-robot physical collaboration (SAPHARI)

The Robotics Laboratory is currently equipped with:

- two articulated manipulators by KUKA (a KR 5 Sixx and an LWR 4+),
- an underactuated arm (Pendubot)
- several mobile robots, including both wheeled (an iRobot MagellanPro plus a team of five K-Team Kheperas III) and legged (an Aldebaran NAO humanoid robot and two quadruped Sony AIBOs) platforms. Finally, two quadrotor UAVs by AscTec (a Hummingbird and a Pelican) are available. All these robots are equipped with sensing devices of various complexity, going from ultrasonic/laser range finders to cameras, Kinect depth sensors and stereo vision systems. In the past, we have also designed and built a two-link flexible manipulator (FlexArm) and a differentially-driven wheeled mobile robot (SuperMARIO).

DIAG Current Projects

- NIFTi - Natural human-robot cooperation in dynamic environments. EU FP7 IP, 2010-14, www.nifti.eu
- RoCKIn - Robots Competitions Kick Innovation in Cognitive Systems and Robotics EU FP7 CA, 2013-15, rockinrobotchallenge.eu
- ROVINA - Robots for Exploration, Digital Preservation and Visualization of Archeological Sites, EU FP7 STREP, 2013-16, www.rovina-project.eu
- SAPHARI - Safe and Autonomous Physical Human-Aware Robot Interaction EU EU FP7 IP, 2011-15, www.saphari.eu (coordinator)
- Smart Monitoring of Complex Public Scenes, US Dept. of Homeland Security (DHS), 2011-13
- I-MULE Min. Sviluppo Economico (Industria 2015), 2011-14, www.progetto-imule.it
- Speaky Acutattile, Min. Sviluppo Economico (Industria 2015), 2011-14, www.fub.it/content/speaky-acutattile

DIAG Past Projects

- ARGOS - Automatic Remote Grand Canal Observation System (Ecotema, Archimedes, Sapienza), 2006-07, www.argos.venezia.it
- CYBERWALK - The CyberCarpet: Enabling Omni-directional Walking in Virtual Worlds EU FP6 STREP, 2005-08, www.cyberwalk-project.org
- Multi-Robot Teams for Environmental Monitoring, US Dept. of Homeland Security (DHS), 2009-11
- PHRIENDS - Physical Human-Robot Interaction: DepENDability and Safety, EU FP6 STREP, 2006-09, www.phriends.eu
- SARFIRE - Spaceborn SAR imagery and environmental data fusion for the dynamical evaluation of land regions susceptibility to fire, ASI, 2010-2012, www.dis.uniroma1.it/~sarfire
- SPEAKY for Robots ECHORD small-scale project, 2012-13, labrococo.dis.uniroma1.it/?q=s4r
- VIEW-FINDER - Vision and Chemiresistor Equipped Web-connected Finding Robots, EU FP6 STREP, 2006-09, www.view-finder-project.eu
- Other ASI projects: SUPER, 2003; PEGASO, 2000-03; MARVISS, 2001-02; Intelligent techniques for real-time diagnosis and supervision of inaccessible autonomous spatial systems, 1998-2001, www.dis.uniroma1.it/~alcor/site/index.php/projects/earth-observation-and-space.html

Education

DIAG coordinates a Master of Science in Artificial Intelligence and Robotics (Italian name: Laurea Magistrale in Intelligenza Artificiale e Robotica). The course is fully taught in English, with large participation of foreign students (>20%). It is active since academic year 2008-09. Additional information can be found at: ccli.dis.uniroma1.it/?q=en/airo

Team

Biosketches of the main components of the team can be found at: www.dis.uniroma1.it/~lastname



Domenico Bloisi



Alessandro De Luca



Marco Fratarcangeli



Giorgio Grisetti



Luca Iocchi



Leonardo Lanari



Daniele Nardi



Giuseppe Oriolo



Fiora Pirri



Marilena Vendittelli

Spin-Off

Algorithmica s.r.l. (<http://algorithmica.it>) is an Italian start-up company that pursues innovation in IT, meaning both innovation in Information Technology and innovation in Italy. Part of the team is composed of researchers and past students from DIAG.

Publications

D. Calisi, L. Iocchi, D. Nardi, G. Randelli, and V.A. Ziparo. Improving Search and Rescue Using Contextual Information In *Advanced Robotics*, 23 (9). 2009. pp. 1199-1216.

Luca Iocchi, Thomas Lukasiewicz, Daniele Nardi and Riccardo Rosati. Reasoning about Actions with Sensing under Qualitative and Probabilistic Uncertainty. *ACM Transactions on Computational Logic (TOCL)*, 10(1), 2009.

A. Farinelli, L. Iocchi, D. Nardi, Multi Robot Systems: A classification focused on coordination, *IEEE Transactions on System Man and Cybernetics*, part B, pp. 2015-2028, 2004.

Alessandro Farinelli, Giorgio Grisetti, Luca Iocchi, Daniele Nardi, Coordination in Dynamic Environments with Constraints on Resources, *IROS Workshop on Cooperative Robotics*, 2002.

C. Candea, H. Hu, L. Iocchi, D. Nardi, M. Piaggio, Coordination in multi-agent RoboCup teams, *Robotics and Autonomous Systems*, 36, pp. 67-86, 2001.

R. Kuemmerle, B. Steder, C. Dornhege, A. Kleiner, G. Grisetti, and W. Burgard. Large Scale Graph-based SLAM using Aerial Images as Prior Information. *Journal of Autonomous Robots*, 30(1):25-39, 2011.

Giorgio Grisetti, Cyrill Stachniss, and Wolfram Burgard. Non-Linear Constraint Network Optimization for Efficient Map Learning, *IEEE - Transactions on Intelligent Transportation systems*

Slawomir Grzonka, Giorgio Grisetti, Wolfram Burgard, Towards a Navigation System for Autonomous Indoor Flying. *ICRA*, 2009 (Best Conference Paper Award)

V. Ntouskos, P. Papadakis, F. Pirri. A Comprehensive Analysis of Human Motion Capture Data for Action Recognition. In *Proceedings of the International Conference on Computer Vision Theory and Applications*, 2012

- P. Papadakis, M. Gianni, M. Pizzoli, F. Pirri. Constraint-free Topological Mapping and Path Planning by Maxima Detection of the Kernel Spatial Clearance Density. In Proceedings of the International Conference on Pattern Recognition Applications and Methods
- F. Pirri, M. Pizzoli and A. Sinha. Coherence Fields for 3D Saliency Prediction. In Proceedings of the International Conference on Biologically Inspired Cognitive Architectures, 2012
- M. Gianni, P. Papadakis and F. Pirri. Shifting and inhibition in cognitive control. In Proceedings of the IROS 2012 Workshop on Cognitive Neuroscience Robotics, 2012
- G. J. M. Kruijff, F. Pirri, M. Gianni, P. Papadakis, M. Pizzoli, A. Sinha, E. Pianese, S. Corrao, F. Priori, S. Febrini, S. Angeletti, V. Tretyakov and T. Linder. Rescue Robots at Earthquake-Hit Mirandola, Italy: a Field Report. In Proceedings of the 10th IEEE International Symposium on Safety Security and Rescue Robotics, 2012.
- M. Cefalo, G. Oriolo, M. Vendittelli, Planning Safe Cyclic Motions under Repetitive Task Constraints. Submitted to 2013 IEEE Int. Conf. on Robotics and Automation (ICRA 2013), Karlsruhe, Germany, May 2013.
- G. Oriolo, A. Paolillo, L. Rosa and M. Vendittelli, Vision-Based Odometric Localization for Humanoids using a Kinematic EKF. 12th IEEE-RAS Int. Conf. on Humanoid Robots (Humanoids 2012), Osaka, Japan, Nov-Dec 2012.
- F. Flacco, A. De Luca, I. Sardellitti, N. Tsagarakis, On-line estimation of variable stiffness in flexible robot joints,” International Journal of Robotics Research, vol. 31, no. 13, pp. 1556-1577, 2012.
- A. De Luca, R. Mattone, P. Robu_o Giordano, H. Ulbrich, M. Schwaiger, M. Van den Bergh, E. Koller-Meier, L. Van Gool, Motion control of the CyberCarpet platform,” to be published in IEEE Transactions on Control Systems Technology, vol. 20, 2012.
- J. Souman, P. Robu_o Giordano, I. Frissen, A. De Luca, M. Ernst, \Making virtual walking real: Perceptual evaluation of a new treadmill control algorithm,” ACM Transactions on Applied Perception, vol. 7, no. 2, 2010.
- A. De Santis, B. Siciliano, A. De Luca, A. Bicchi, An atlas of physical human-robot interaction,” Mechanism and Machine Theory, vol. 43, no. 3, 2008.

University of Rome Tor Vergata – DISP

DISP: Summary Table	
Institute	University of Rome Tor Vergata,
Year of foundation	1981 by S. Nicosia
Reference person	Prof. Antonio Tornambè
Website	Not Available
Scientific Areas	Non Linear and Hamiltonian Systems; Control Systems; Electronic design
Robotic Applications	mainly Medical Robotics, Industrial Robotics
Scientific Expertise	Control Theory
Team size	20
Senior researchers	4

Introduction

DISP Automation engineering is composed by 3 full professors, 2 associate professor and 4 researcher as fixed people together with about 20 students. Totally it has about 30 skilled people. The team is mainly involved with local industries and has some international cooperation. This last activities are on medical robotics together the Imperial college of London, but is also active in theoretical development of control system based on equation symmetries

Educational activity

DISP Automation engineering produces about 20 master people each year. Every one find a qualified job in local industries like ELM or international way as Imperial college of London or ABB robotics in Switzerland. Some of these students come from other engineering course because they are attracted by job possibility; unfortunately the number are decreasing owing to the difficult of the course.

In ROMA1 the faculty it is just closed. Actually there are two courses. Laboratory robotics and Industrial robotics, with special care to medical robotics. For the laboratory course was used the SCORBOT educational robot but by now the students are able to realize themselves the robots. They using real time Linux modifying the kernel. They realize terrestrial mobile robots for structured environment using RFID as marker for indoor navigation and localisation. These markers can be active if you send low power energy by electromagnetic waves and are very cheap. The mobile robot prototype has a cost less than 10 thousand euro. In the early was developed by Arduino platform but later using ST microprocessors. The students also work on freeware simulator like processing.

Research

The research is developed especially about theoretical aspects.

The windup (i.e. non linear overshooting of a controller) problem.

Analysis of non linear system, using symmetries, Hamiltonian system and first integral to develop new control system, Control system for robot with infinite freedom degree, like snake robot.

A project regarding a snake robot (3 million euro) for endoscopy has been commissioned by Zeus company; The theoretical aspects linked to the particular snake movement are under study, leading to a new control system of the robot.

Many devices has been realized. Among these the principal are:

- A robotics wheel chair. Its peculiarity lies in the memory shape materials able to be safe during the not controlled movement of the patient on it.
- A VAD (Ventricular assisted device) to help human heart.
- A portable insulin pump with real time control monitoring of the glucose in the blood.
- The control system of the Vega missile.

Other activities

The DISP has many orders from local industries and the department is a reference point for them. As example Trenitalia has commissioned a mobile robot to prevent fire into the High voltage building, to measure temperature close to the transformer. The mobile robot is localised by cheap RFID.

An automatic flux control of wine was developed for a wine cellar to monitorise it in real time.

Experience of the Nemi lake, that is completely sensorised, was performed.

Despite of its interaction with the local administration and firms the group, owing to its highly theoretical address, is less favorite than other realities in identify and get adequate resources for its projects. The team is therefore often engulfed in its mission to individuate the right development activities and with the problem of high skill recruitment, considering the difficulty to held young researchers inside the university once they finished the course.

DISP also needs technicians for laboratory management to enhance the productivity of young researchers that are usually forced to spend a large part of their time to instrumentation maintenance.

Team



Prof. A. Tornambè



Prof. L. Menini

Publications

Menini L., Tornambe A., “Design of state detectors for nonlinear systems using symmetries and semi-invariants “, *Systems and Control Letters*, Volume 60, Issue 2, 2011, pp. 128-137

Menini L., Tornambe A., “Darboux Polynomials for Lie Algebras “, *Proc. of the 18th {IFAC} World Congress*, 2011, pp. 5872-5877

Menini L., Tornambe A., “Design of state detectors for nonlinear systems using symmetries and semi-invariants “, *Proc. of the Decision and Control and European Control Conference (CDC-ECC)*, 2011 50th IEEE Conference on, 2011, pp. 1092-1097

Menini L., Tornambe A., “Stability analysis of planar systems with nilpotent (non-zero) linear part “, *Automatica*, Volume 46, Issue 3, March 2010, pp. 537-542

Menini L., Tornambe A., “Computation of the real logarithm for a discrete-time nonlinear system “, *Systems and Control Letters*, Volume 59, Issue 1, pp. 33-41

Antonio Tornambè, “Discrete-Event System Theory: an introduction”, World Scientific Publishing, Singapore, 1995

Menini, L.; Tornambe, A.; Zaccarian, L., “Mathematical Methods for System Theory”, World Scientific Publishing, Singapore, 1998, ISBN 10: 9810233345 / ISBN 13: 9789810233341

University Campus Bio-Medico

BIOMEDICAL ROBOTICS AND BIOMICROSYSTEMS LAB

UNICAMPUS: Summary Table	
Institute	University Campus Bio-Medico, Via Álvaro del Portillo, 21 – 00128, Rome
Year of foundation	2004
Reference person/s	Eugenio Guglielmelli e.guglielmelli@unicampus.it +39 06 22541 9610
Website	http://main.biorobotics.it/
Scientific Areas	Man-machine interface; Biorobotics , Mechatronics
Robotic Applications	Medical robotics Assistive Robotics
Scientific Expertise	Systems engineering and electronic design; Informatics; Control theory; Neuroscience
Team size	20
Senior researchers	5

Mission

Biomedical Robotics and Biomicrosystems Lab investigates the application of mechatronics, robotics and microengineering to medicine and biology, by proposing innovative solutions for diagnosis, therapy and the overall improvement of quality of life.

Introduction

The Biomedical Robotics and Biomicrosystems Lab at University Campus Bio-Medico (Rome) was established in 2004 under the head Prof. Eugenio Guglielmelli. The research activities are focused on applications of robotics for biomedical purposes related to Rehabilitation and Bio-engineering, Neuro-developmental Engineering and Biomicrosystems. Prof. Guglielmelli and his closest associates have received their scientific training in the laboratories of Prof. Paolo Dario at Scuola Superiore Sant'Anna of Pisa. This common background is at the basis of the strict collaboration between Guglielmelli's Lab and the Biorobotics Institute of Scuola Superiore Sant'Anna.

In less than 10 years, the group achieved excellent results publishing more than 60 scientific publications, 8 patents and raising total founding for 5 Mln euro. The group is composed of nearly 20 people, 5 of which are faculty members. About 15 PhD students and post-doc researchers are involved in the research activities.

The laboratory strongly benefits from the tight link with the School of Medicine and Surgery, and with its University Polyclinic, for developing and validating innovative biomedical robotics technologies with high safety, reliability, robustness and acceptability, based on a solid human-centered design approach and with a special attention given to the human-machine interaction.

As a result of the activities of NEUROBOTICS international scientific consortium (composed among the others of Scuola Superiore Sant'Anna, University Campus Biomedico and Fraunhofer IBMT), the first human implant of an hand neuroprosthesis directly linked to peripheral nerves (i.e. to the brain) was performed at University Campus Biomedico in 2009. The surgical procedure allowed to test the bidirectional communication between 4 invasive electrodes into ulnar and median nerves of a young amputee.

Scientific results

The research areas are divided in the following 3 main activities.

Rehabilitation Bio-engineering

The research activities of this field beneficiate of a strict collaboration with CESA (Centro per la Salute dell'Anziano). The center is specialized on rehabilitation and sanitary assistance of elderly as well as on activities with a social nature. The collaboration between CESA and The Biomedical Robotics and Biomicrosystems Lab introduced robotics in clinical practices. Robotic platforms as InMotion2 (Shoulder-elbow module, MIT-manus) and InMotion3 (Wrist module) are usually employed for the rehabilitation of post-stroke patients at CESA.

The research in this area is focused on:

Methods and Systems for Robot-Mediated Motor Therapy

- Design and development of Cartesian robotic machines for motor recovery of the upper limb in post-stroke patients;
- Analysis and control of exoskeletal systems for the rehabilitation of the upper and lower limb in people with reduced motor capabilities;
- Interfaces and human-Machine interaction control systems for Cartesian and exoskeletal rehabilitation machines.

Functional Assessment

- Mechatronic devices for functional assessment;
- Use of brain imaging techniques (EEG, MEG, fMRI) for evaluating robot-assisted neuro-rehabilitation therapy and generating adequate corrective actions;
- Biomechanical studies and analysis of the basic mechanisms of biological motor control of the upper limb;
- Methods and techniques for measuring visco-elastic properties of the upper limb.

Assistive Technology

- Human Factors Bioengineering;
- Integrated systems for assistance to the elderly and the disabled;
- Technical aids for the integration of youth disabled in education;
- Personal robotics and Domotics;
- Human-machine interfaces based on non-invasive neural interfaces (EMG, EEG);
- Clinical and socio-economical evaluation of devices and services for personal assistance.

Neurodevelopmental Engineering

This is a new interdisciplinary research area at the intersection of developmental neuroscience and bioengineering aiming at providing new methods and tools for: Understanding neuro-biological mechanisms of human brain development

- quantitative analysis and modeling of human behavior during neuro-development
- assessment of neuro-developmental milestones achieved by humans from birth onwards
- Studying neuro-developmental disorders
- Conceiving new telematic, mechatronic and robotic components and systems for applications on infants and toddlers, which can be used also in ecological conditions for long periods of time
- Investigating ethical, epistemological and social implications related to this area.

Biomicrosystems

The research of biomicrosystems group aims at exploring the interface of macro- and micro- world in order to increase the degrees of freedom in the design of innovative biomedical robotic tools. Current research efforts are aimed at developing:

- Design techniques based on multi-domain and multi-physics analyses and simulations;
- Miniature sensors for biorobotics, with application to minimally invasive surgery and prosthetics;
- Novel actuators based on (electro)chemical phenomena;
- Microfluidic platforms for the biosciences and drug-delivery;
- Technologies for the development of novel invasive neural interfaces, with special focus on electrodes coating techniques;
- Energy harvesters for improving the autonomy of fully implanted active devices.

Facilities

The core facilities available at the Biomedical Robotics and Biomicrosystems Lab include:

- InMotion2 - Shoulder-elbow module (MIT-manus)
- InMotion3 - Wrist module
- System for whole body isometric force/torque measurements (Alladin)
- Catching platform
- Polhemus, X-sense
- Stereolithographic station for rapid-prototyping (ZPrint 310 plus)
- Microfabrication facilities (clean room class 1000, 30 m² with spin-coater and sputter)

Software

- Matlab/Simulink
- LabView
- Comsol Multiphysics
- SolidWorks

Collaborations

Research: List main national and international collaboration agreements with other research groups.

Industry and other:

- MASMEC Spa (<http://www.masmec.org/it>) selected the Biomedical Robotics and Biomicrosystems Lab to perform clinical validation at University Campus Biomedico of one of its new biomedical devices
- Framework agreement with Fondazione Mondo Digitale

Projects

Current projects:

- EVRYON - STREP, FP7-FET Proactive 5, EMBODY (2009-2013), EU
The purpose of the project was to design and implement an innovative non-anthropomorphic exoskeleton for rehabilitation of the lower limbs based on the results of biomechanical simulations. <http://www.evryon.eu/>
- IM-CleVeR - FP7-ICT-IP-231722 (2009-2013), EU
The project aim was to investigate the role of novelty in learning strategies in children and animal models by developing an ad-hoc mechatronic platform able to provide different levels of complexity of audio and video stimuli. <http://www.im-clever.eu/>
- ITINERIS2, - Lazio Region
Enhancement program of research for technological innovation of SMEs and the development of new businesses in the biomedical sector in Lazio region.
- OPENHAND- PRIN 2008, PMZT2Z. Italian Ministry of Research
The project is aimed at addressing the scientific problem of functional substitution between natural and artificial hand, by developing an open neuro-prosthesis platform to be clinically evaluated by means of different neural interfaces (intraneural, Cuff, etc).
- TIME - STREP CP-FP-INFOS, n. 224012, (2008-2013), EU
The ultimate aim is to develop a Human Machine Interface to manipulate phantom limb sensations in volunteer amputee subjects by the application of multi-channel microstimulation. <http://www.project-time.eu/>

Past Projects:

- IDIS-C2 - Funded by Bristol-Myers Squibb.
The aim of the project was to design a prototype of novel drug infusion systems for the cerebral compartment.
- TACT (Thought in Action)- Financed by the European Union's NEST-Adventure Program.
The aim was developing non-obtrusive, user-friendly technological aids and methods allowing the extraction of more information from infant movement than is currently possible.
- ALLADIN - FP6, IST-2002-507424, EU
The project focused on the development of a user-friendly natural language based decision support software for neuro-rehabilitation, in particular in stroke. <http://www.alladin-ehealth.org/>
- NEUROBOTICS- EU IST-001917
The project was based on the fusion of neuroscience and robotics for augmenting human capabilities.

Education activities

University Campus Biomedico is the only Italian private university to offer degree courses in engineering. Most of its students come from central and southern Italy. The faculty of engineering offers undergraduate degree in Industrial Engineering and Master of Science in Biomedical Engineering and in Chemical Engineering for Sustainable Development. The number of students accepted to the first year of industrial engineering is 120 units. The Biomedical Robotics and Biomicrosystems Lab coordinates the courses of Biomicrosystems and Rehabilitation Bioengineering.

The Biomedical Robotics and Biomicrosystems Lab was partner of the project ROBODIDACTICS in collaboration among the others with Fondazione Mondo Digitale, Scuola di Robotica, RoboTech s.r.l. and 3 different schools in each country (Italy, The Netherlands, Poland, Germany and Slovenia). The project had the aim to promote the development of an educational methodology for introducing robotics in didactics, taking stock of both relevant knowledge on robotics practices at European level and the extensive expertise among partners. As a result of the project, the first edition of RomeCup (<http://www.romecup.org/>) was established in 2007.

Team

Eugenio Guglielmelli received the Laurea degree in Electronics Engineering and the PhD in Biomedical Robotics from the University of Pisa, Italy, in 1991 and in 1995. He is currently Full Professor of Bioengineering at Campus Bio-Medico University (Rome, Italy) where he serves as the Head of the Laboratory of Biomedical Robotics and Biomicrosystems, that he founded in 2004. From 1991 to 2004 he worked with prof. Paolo Dario at the Advanced Robotics Technology & Systems Laboratory (ARTS Lab) of the Scuola Superiore Sant'Anna (Pisa, Italy). His main current research interests are in the fields of human-centred robotics, biomechatronic design and biomorphic control of robotic systems, and in their application to robot-mediated motor therapy, assistive robotics, and neurorobotics.



Dino Accoto
Assistant professor



Loredana Zollo
Assistant professor



Domenico Formica
Assistant professor



Fabrizio Taffoni
Assistant professor

Publications

Accoto, D., Francomano, M. T., Rainer, A., Trombetta, M., Rossini, P. M., & Guglielmelli, E. (2013). An implantable neural interface with electromagnetic stimulation capabilities. *Medical Hypotheses*, 81(2), 322-327.

Francomano, M. T., Accoto, D., & Guglielmelli, E. (2013). Artificial sense of slip - A review. *IEEE Sensors Journal*, 13(7), 2489-2498.

- Mazzoleni, S., Munih, M., Toth, A., Cinkelj, J., Jurak, M., Van Vaerenbergh, J., . . . Guglielmelli, E. (2013). Whole-body isometric force/torque measurements for functional assessment in neuro-rehabilitation: User interface and data pre-processing techniques. *Computer Methods and Programs in Biomedicine*, 110(1), 27-37.
- Moscato, M., Schena, E., Saccomandi, P., Francomano, M., Accoto, D., Guglielmelli, E., & Silvestri, S. (2012). A micromachined intensity-modulated fiber optic sensor for strain measurements: Working principle and static calibration. Paper presented at the Proceedings of the Annual International Conference of the IEEE Engineering in Medicine and Biology Society, EMBS, 5790-5793.
- Sergi, F., Accoto, D., Tagliamonte, N. L., Carpino, G., Galzerano, S., & Guglielmelli, E. (2012). Kinematic synthesis, optimization and analysis of a non-anthropomorphic 2-DOFs wearable orthosis for gait assistance. Paper presented at the IEEE International Conference on Intelligent Robots and Systems, 4303-4308.
- Tagliamonte, N. L., Sergi, F., Accoto, D., Carpino, G., & Guglielmelli, E. (2012). Double actuation architectures for rendering variable impedance in compliant robots: A review. *Mechatronics*, 22(8), 1187-1203.
- Ciancio, A. L., Zollo, L., Baldassarre, G., Caligiore, D., & Guglielmelli, E. (2012). The role of thumb opposition in cyclic manipulation: A study with two different robotic hands. Paper presented at the Proceedings of the IEEE RAS and EMBS International Conference on Biomedical Robotics and Biomechatronics, 1092-1097.
- Cordella, F., Di Corato, F., Zollo, L., Siciliano, B., & Van Der Smagt, P. (2012). Patient performance evaluation using kinect and monte carlo-based finger tracking. Paper presented at the Proceedings of the IEEE RAS and EMBS International Conference on Biomedical Robotics and Biomechatronics, 1967-1972.
- Cordella, F., Zollo, L., Guglielmelli, E., & Siciliano, B. (2012). A bio-inspired grasp optimization algorithm for an anthropomorphic robotic hand. *International Journal on Interactive Design and Manufacturing*, 6(2), 113-122.
- Papaleo, E., Zollo, L., Sterzi, S., & Guglielmelli, E. (2012). An inverse kinematics algorithm for upper-limb joint reconstruction during robot-aided motor therapy. Paper presented at the Proceedings of the IEEE RAS and EMBS International Conference on Biomedical Robotics and Biomechatronics, 1983-1988.
- Pellegrino, G., Pellegrino, G., Tombini, M., Assenza, G., Bravi, M., Sterzi, S., . . . Tecchio, F. (2012). Inter-hemispheric coupling changes associate with motor improvements after robotic stroke rehabilitation. *Restorative Neurology and Neuroscience*, 30(6), 497-510.
- Salerno, A., Zollo, L., & Guglielmelli, E. (2012). Dynamic submovement composition for motion and interaction control of a robot manipulator. Paper presented at the Proceedings of the IEEE RAS and EMBS International Conference on Biomedical Robotics and Biomechatronics, 1323-1328.

Mondo Digitale

Mondo Digitale: Summary Table	
Institute	Mondo Digitale foundation, Via del Quadraro 102 – 00174, Rome
Year of foundation	2002
Reference person/s	Alfonso Molina, Marta Michilli info@mondodigitale.org +39 06 22541 9610
Website	http://www.mondodigitale.org/
Scientific Areas	N.A.
Robotic Applications	Education
Scientific Expertise	N.A.
Team size	20
Senior researchers	5



Fig. 70 - Città Educativa launch

“Fondazione Mondo Digitale” (FMD) is a Foundation initially born in Rome in 2001 with a different name, by a cooperation among Rome township and six large TLC industries (Elea, Engineering, eWorks, Unisys, Wind and ACEA) with the name of “Consorzio Gioventù digitale”, then it became Foundation in 2007 with the inclusion of further cofounders (namely Regione Lazio and INTEL), and is still supported for about a quarter of his yearly expenditures by the Rome township with the project “Città Educativa”. This institution is one of about 300 Educating Cities all around the world with an International Association born in 1990 in Barcelona.

“Mondo Digitale” recently (2009) focused its interest on robotics, mainly because Robotics has been evaluated as a great tool to fire-up the attention and the curiosity of young generations on the scientific education. To achieve this aim “Mondo Digitale” launched the Association “Rete della Robotica”, a Convention initially signed by 53 large research, industrial and educational bodies that pushed to spread the robotics culture within the national instruction institutes.

Rete della Robotica also produced a White Book with the objective to put in evidence an educational market of “request” (of the scholastic institutes) and of the “offer” (Industries, Academies and Research Bodies) to identify the potentialities of this sector, to promote an effective cooperation and to define models for the transfer of instruction elements from the excellence robotics stakeholders toward the school. The ambition is to bring these models to the level of the public education.

Currently, the organizations that signed the Rete della Robotica agreement are become 62 and the list of them is reported at the end of this presentation.



Fig. 71 - The humanoid robot Nao to Intel stand at the Rome Cup

Also large events have been organized like the series of Rome Cup, based on competitions among young students of all the Italian school Institutes that use their fantasy to program, design and test robotics systems.

Mondo Digitale is currently engaged to become a reference point for the Italian Public Administration in the themes of education to the science and technology subjects and to start a discussion with MIUR to bring at an official level some of the experiences and the requests that are arising from the base of scholastic institutes.

The main actors and leaders of FMD are prof. Alfonso Molina, prof. of Technology Strategy at Edinburgh University and Marta Michilli leader of several initiatives at national and international level and Director of Eurolaboratorio, an innovative organization of Informatics Department of Municipality of Rome.

The Foundation, despite its efforts, is not at the moment one of the big players in the area of educational Robotics, but has a great potential to become something much more effective. It's role is in fact from one hand to stimulate the already existing trend of academies, Research Institutes and industries to support the teaching “of” robotics and “through” robotics in the schools and on the other hand to increase the sensitivity of the Public Administration to incorporate this new technological approach in the organization of the technical high schools.

The potential comes from the contacts established with many national and international players and by its legal structure. It could start up a number of highly innovative initiatives with a flexible and quick structure and with the possibility to check the interest of large operators like its founders and co-founders and many others. Some proposals to unleash this potential are reported in the “proposals” section.

List of participants to the network “Rete della Robotica”

- Fondazione Mondo Digitale, via Umbria 7, 00187 Roma, presidente prof. Tullio De Mauro
- Istituto Italiano di Tecnologia, via Morego 30, 16163, Genova, prof. Giulio Sandini
- Ufficio Scolastico Regionale per il Piemonte, via P. Micca 20, 10122 Torino, Rete Robocup junior Italia, prof. Carmelo Arcoraci, dirigente scolastico IIS Marconi Galletti di Domodossola – capofila under 19 della Rete e prof. Giovanni Marcianò, dirigente scolastico IC Reborà di Stresa – capofila under 14 della Rete
- Scuola Superiore Sant’Anna di Pisa, p.za Martiri della Libertà 33, prof. Paolo Dario, direttore Polo Sant’Anna Valdera, v.le Piaggio 34, 56025, Pontedera (Pisa)
- Rete Robotica a scuola, via Lavagna 8, Torino (c/o Ipsia G. Galilei), coordinatore Enzo Marvaso
- COMAU spa, Via Rivalta 30, 10095, Grugliasco (TO), Maurizio Filoni, Chief operating Officer Comau Robotics e Service
- Unione industriale di Torino, via Fanti 17, 10128 Torino, vice direttore Riccardo Rosi
- AMMA (Aziende Meccaniche Meccatroniche Associate), via Vela 17, Torino, ing. Francesco Mosca
www.mondodigitale.org 5
- Camera di Commercio di Torino, via Carlo Alberto 16, 10123 Torino, dr. Patrizia Paporozzi
- Università di Torino, Facoltà di Scienze della formazione via S. Ottavio 20, 10123 Torino, preside di Facoltà prof. Renato Grimaldi
- CNR-ITD Consiglio Nazionale delle Ricerche – Istituto per le Tecnologie didattiche, via De’ Marini 6, 16149, Genova, dr. Augusto Chiocciariello
- CNR-IEIIT Consiglio Nazionale delle Ricerche – Istituto di Elettronica e di Ingegneria dell’Informazione e delle Telecomunicazioni, via De Marini 6, 16149 Genova, ing. Gianmarco Veruggio
- STMicroelectronics srl, Agrate Brianza (MB), via C. Olivetti, 2, direttore generale, Pietro Palella and dr. Maria Teresa Gatti
- Intel Corporation Italia spa, Milanofori Palazzo E 4, 20094 Assago (MI), John Davies, vice president of Programma Intel “World Ahead” for Intel Corporation
- Carisma srl di Borgaro T.se (TO) via Mappano 34, 10071, rappresentante legale Gregori Massimiliano
- Euroa Srl, via Po 77, 20032 Cormano (MI), Stefano Avenia, amministratore delegato
- Media Direct SRL, Via Villaggio Europa 3, 36061 Bassano de Grappa (VI), Pierluigi Lanzarini, direttore commerciale
- ENEA (Agenzia nazionale per le nuove tecnologie, l’energia e lo sviluppo economico sostenibile) Roma, Lungotevere Thaon di Revel 76, ing. Gian Piero Celata, Responsabile Unità Tecnica Tecnologie Avanzate per l’Energia e l’Industria dell’ENEA autorizzato con Disposizione Commissariale n. /2011/COMM del
- AI*IA (Italian Association for Artificial Intelligence), DEIS – Università di Bologna (sede di Cesena), via Venezia 52, 47023 Cesena (FC), presidente prof. Paola Mello 6 Fondazione Mondo Digitale
- SIRI (Associazione Italiana di Robotica e Automazione), v.le Fulvio Testi 128, 20092 Cinisello Balsamo (MI), prof. Rezia Molfino
- GRIN (Gruppo Ricercatori Italiani Università) Pisa, Dipartimento di Informatica, Università degli Studi di Pisa, Largo B. Pontecorvo, 3, 56127 Pisa, prof. Giuseppina Barbara Demo, coordinatrice del gruppo di lavoro Informatica e scuola.
- Museo Civico di Rovereto, Borgo S.Caterina n.41, 38068 Rovereto (TN), dr. Franco Finotti
- Scuola di Robotica, Associazione Culturale, Genova, Viale Corsica 19/10 16128, president Fiorella Operto
- Associazione di promozione sociale “Iper Lab”, via Lepanto 126, 89046 Marina di Gioiosa Jonica (Reggio Calabria), prof. Salvatore Napoli, residente in via Lepanto 126 a, 89046 Marina di Gioiosa Jonica (Reggio Calabria)
- Mare Nostrum srl, per “Mediterraneum - Acquario di ROMA”, viale America 93, Prof. Ing. Domenico Ricciardi
- DiScienza di Roma via Pupinia, 23, 00133, presidente Leonardo De Cosmo
- Università degli studi di Roma “Sapienza”, Dipartimento di Informatica e Sistemistica “Antonio Ruberti”, Via Ariosto 25, Roma, professor Daniele Nardi
- Università Campus Bio-Medico di Roma, via Alvaro del Portillo 21, prof. Luigi Marrelli, preside della Facoltà di Ingegneria
- Università degli studi Roma Tre, Dipartimento di Informatica e Automazione, Roma, via della Vasca Navale 79, professor Stefano Panzieri

- Università degli studi di Roma Tor Vergata, Dipartimento di Ingegneria Elettronica- Gruppo Sensori e Microsistemi, via del Politecnico 1, professor Arnaldo D'Amico
- Università degli studi di Napoli Federico II, Dipartimento di Informatica e Sistemistica, via Claudio 21, prof. Antonino Mazzeo
- Politecnico di Milano AI & Robotics Lab, Dipartimento di Elettronica e Informazione, via Ponzio 34/A, 20133 Milano professor Andrea Bonarini
- Università degli studi di Catania, Dipartimento di Ingegneria elettrica elettronica e informatica, viale A. Doria 6, 95125 Catania, rettore Antonino Recca e dal professor Giovanni Muscato
- Università di Padova, Laboratorio di Sistemi autonomi intelligenti (IASLab) del Dipartimento DEI dell'Università di Padova, via G. Gradenigo 6, responsabile professor Enrico Pagello
- Università di Parma, VisLab - The Artificial Vision and Intelligent Systems Lab, Dip. di Ingegneria dell'Informazione, professor Alberto Broggi
- Università degli studi di Brescia, Brescia – p.zza mercato n.15, magnifico rettore prof. Sergio Pecorelli
- Università degli studi di Palermo, Dipartimento di Ingegneria Chimica, Gestionale, Informatica, Meccanica, Viale delle Scienze, professor Antonio Chella (delegato dal direttore prof. Carmelo Sunseri)
- Officina Emilia. Laboratorio di storia delle competenze e dell'innovazione nella meccanica. Università degli Studi di Modena e Reggio Emilia via Tito Livio 1, 41123 Modena responsabile scientifico Margherita Russo
- Politecnico di Torino C.so Duca degli Abruzzi 24, 10129, Rettore Prof. Marco Gilli
- Polo Formativo a supporto dello sviluppo e dell'innovazione della Meccanica Strumentale e dell'Industria Manifatturiera Lombarda denominato in breve "PoloMeccanica" v.le Fulvio Testi 128, 20092 Cinisello Balsamo (MI), Claudio Bobbi
- IPSIA "G. Galilei", Via Lavagna, 8, Torino dirigente scolastico prof. Franco Francavilla 8 Fondazione Mondo Digitale
- II Circolo Didattico di Eboli (Sa), via Generale Ferrante Gonzaga, Eboli (Sa), Dirigente scolastico Celestino Rocco
- IPSIA "G. Fascetti" di Pisa via Rindi 47, 56123, dirigente scolastico dr. Mariangela Chiapparelli
- IIS "G. Vallauri" di Fossano (CN) via San Michele 68, 12045, dirigente scolastico dr. Paolo Cortese
- Collegio Universitario ARCES di Palermo via Lombardia, 6, 90144, l'ing. Antonina Oliveri
- ITI "Archimede" di Catania viale Regina Margherita 22, 95123, dirigente scolastico prof. Romana Romano
- ITI "F.Giordani" di Caserta Caserta Via Laviano 18, 8100 dirigente scolastico prof. Francesco Villari
- IC "Mozart" di Roma viale di Castel Porziano 516, 00124, dirigente scolastico prof. Giuseppina Palazzo
- IIS "U. Midossi" con S.M.A. Civita Castellana (VT) Via Petrarca snc 01033 dirigente scolastico prof. Franco Chericoni
- ITI "S.Cannizzaro" di Catania via Pisacane, 1, 95122, dirigente scolastico Salvatore Indelicato
- ITI "A. Pacinotti" di Roma via Montaione 15, 00139, la vicepresidente Loredana Zampardi
- ITIS "Avogadro" di Torino Corso San Maurizio 8, 10124, dirigente scolastico Tommaso De Luca
- ITI "Pininfarina" di Moncalieri (TO) via Ponchielli 16, 10024, dirigente scolastico Ing. Stefano FAVA
- IIS "Olivetti" di Ivrea (TO) Colle Bellavista, 10015, dirigente scolastico Daniela Vaio
- ITI "Marconi" di Pontedera (PI) via Milano 51, 56025, dirigente scolastico Pierluigi Robino www.mondodigitale.org 9
- Istituto di Istruzione Superiore "J. Von Neumann" di Roma, via Pollenza 115, 00156, dirigente scolastico Eugenio Leone
- Istituto Comprensivo "Via N. M. Nicolai" Roma, via Nicola Maria Nicolai 85, 00156 Dirigente Scolastico Gabriella Romano
- A.N.F.OR – Associazione Nazionale per la Formazione e l'Orientamento – Taranto, Via Lago di Como 63/L, Presidente dr. Giuseppina Dragonetti
- Istituto Comprensivo "Vivaldi-Murialdo" di Torino via Casteldelfi no 24 – 10147, Dirigente Scolastico Francesco Augusto Grassi e sottoscritto in data 19 ottobre 2012
- Istituto Comprensivo "Giovanni Falcone" di Mappano (TO) via Tibaldi, 70 – 10071, Dirigente Scolastico Lucrezia Russo e sottoscritto in data 6 novembre 2012
- Istituto Tecnico Commerciale "Vincenzo Arangio Ruiz" di Roma, viale Africa 109, 00144 Dirigente Scolastico Maria Grazia Lancellotti

Southern Italy

A most interesting integration among research, academy and Public Administration

In the robotics Italian community, the common convention that in the north of the Italy there is the maximum of innovation, technology and research and in the south lacking of initiatives and of skill is not respected. Universities of Naples, Catania and research centers like the one of CNR in Bari are among the most respected and influent international groups, enriched by some of the most known researchers in the world.

University Federico II, in particular, was able to realize a network that includes at least five important research groups and deeply affect the European policies in this research area.

In terms of cooperation between research and industry we cannot avoid to highlight the long term experience involving Catania University and ST microelectronics, were the skill and the competence of the research group in robotics has been entirely transferred, year after year, to the big world leader player of electronics.

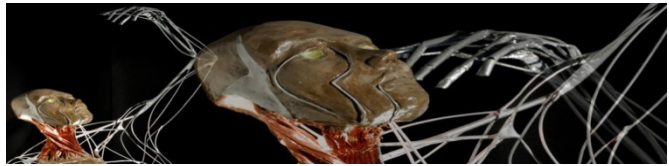

PRISMA-LAB: Summary Table	
Institute	Robotics and Automation Group of the University of Naples “Federico II” and Partners
Year of foundation	
Reference person/s	Bruno Siciliano siciliano@unina.it (+39) 081 76-83179
Website	http://www.prisma.unina.it/
Scientific Areas	Man-machine interface Distributed Robotic Systems Sensors and perception Biorobotics Mechatronics
Robotic Applications	Industrial robotics, Assistive Robotics Entertainment Robotics, Mobile robotics (ground, aeronautics, marine)
Scientific Expertise	Mechanical Design Mechanical construction Systems engineering and electronic design Informatics Signal processing Control theory
Team size	45
Senior researchers	14

Mission

Development of project addressed to industrial robotic, automation mechatronic and service.

Introduction

The PRISMALAB is the result of the joint of six research universities teams (Napoli, Cassino, Salerno, Basilicata, Napoli 2, Roma 3). It is composed by four Professors, five Associate Professors and five Assistant Professors and students (5 PostDoc , 7 PhD, 20 MS and 3 TechEng).

It has about 30 years of research experience and 1.5 Mln euro of financial support each year. The team has collaboration agreements with 40 foreign institutions, performed 150 seminars and invited talks, has published 15 books and 15 edited volumes, 200 journal papers and 600 conference papers. Its activity span from manipulator to aerial robots and artificial vision. The philosophy of the team is to constitute a group with a critical mass of competencies to compete in international research. Historically the department was born from automation engineering but now is a complete independent reality.

Scientific results

The research activities of the PrismaLab and the team of six universities are essentially supported by European projects. An international cooperation with many countries and institution is well established, see the website for more details. A project is based on the Impedance control with inner motion control loop i.e. Force/torque measurements for linear and decoupled impedance and Compliant frame between desired and EE frame (disturbance rejection).



Fig. 72 - COMAU Smart 3-S robot with Open control architecture, ATI force/torque sensor and 6-DOF spatial impedance

Visual servoing technique, which uses feedback information extracted from a vision sensor to control the motion of a robot, are also developed as example in grasping and 3D monocular ball catching.

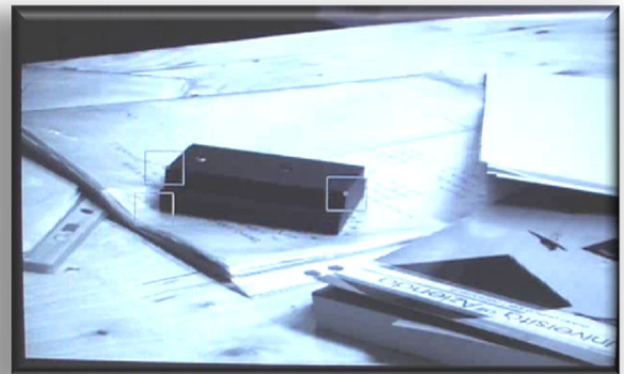

Fig. 73 - Visually guided grasping for Object in unstructured environment. Visual servoing and Tracking of object motion. Good reaction to uncertainties



Fig. 74 - Manipulator developed in the Phriends project

The PrismaLab has developed a manipulator, in the frame of Phriends European project, that can co-exist and co-operate with people, enabling a human robot interaction, which is dependable and safe.

Cooperation between aerial robot was the object of the European project Arcas.

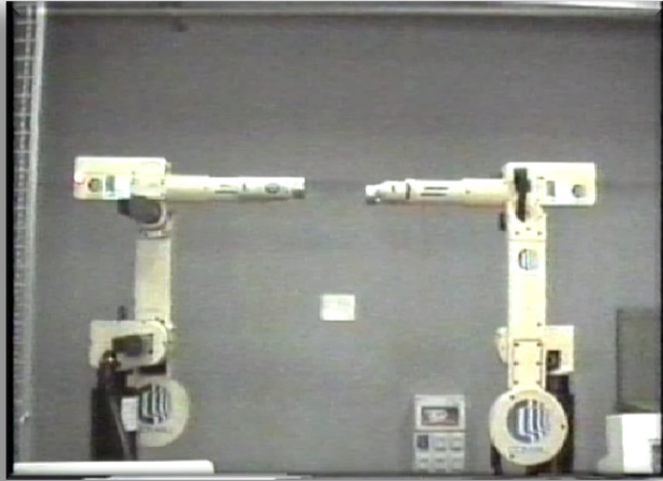
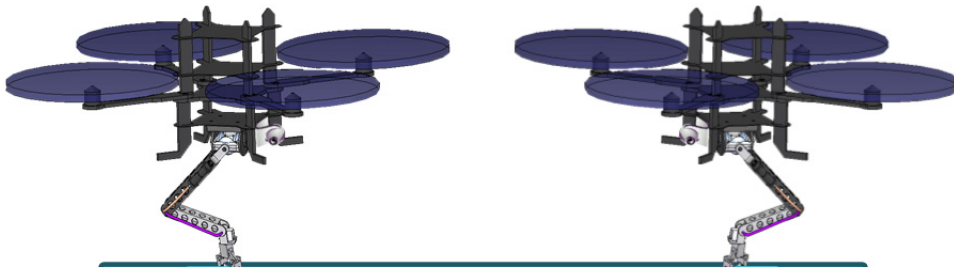

Fig. 75 - Dual arm manipulator. Control of absolute motion and internal forces



Collaborations

Funding

The PrismaLab has also funding also from the following institution:

- Agenzia Spaziale Italiana
- Commission of the European Community
- Consiglio Nazionale delle Ricerche
- Ministero dell'Università e della Ricerca
- NATO
- Regione Campania.

Research collaborations

- Commission of the European Community
- Consiglio Nazionale delle Ricerche
- Ministero dell'Università e della Ricerca
- NATO

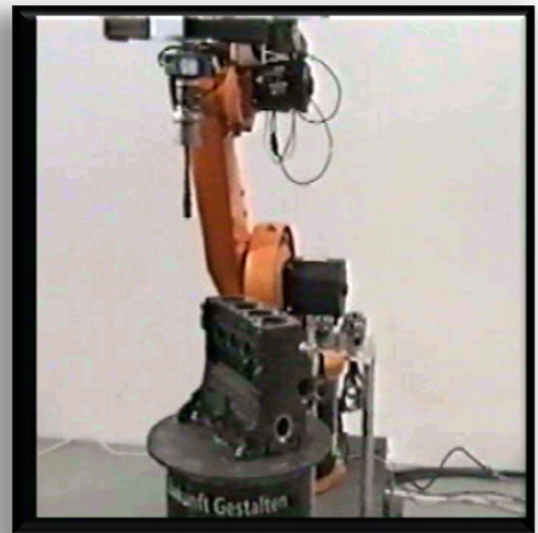

Fig. 76 - KUKA robot with force sensor and camera embedded in the gripper

- Alma Mater Studiorum Università di Bologna, Ingegneria dell'Energia elettrica e dell'Informazione "Guglielmo Marconi", Laboratory of Automation and Robotics, Bologna, Italy
- Agenzia Spaziale Italiana (ASI), Rome, Matera, Italy
- Centre National de la Recherche Scientifique, Laboratoire d'Analyse et d'Architecture des Systèmes (LAAS), Toulouse, France
- Commissariat à l'Energie Atomique (CEA), Laboratoire d'Intégration des Systèmes et des Technologies (LIST), Fontenay-aux-Roses, France
- Deutsches Zentrum für Luft- und Raumfahrt e.V. (DLR), Institut für Robotik und Mechatronik, Oberpfaffenhofen, Germany
- Eidgenössische Technische Hochschule Zürich (ETH Zürich), Institute of Robotics and Intelligent Systems, Autonomous Systems Lab, Zürich, Switzerland
- Fraunhofer-Gesellschaft, Institut für Optronik, Systemtechnik und Bildauswertung, Karlsruhe, Germany
- Fundación Andaluza para el Desarrollo Aeroespacial (FADA), Centro Avanzado de Tecnologías Aeroespaciales (CATEC), Sevilla, Spain
- Georgia Institute of Technology, School of Mechanical Engineering, School of Aerospace Engineering, Atlanta, GA, USA
- Isfahan University of Technology, Department of Mechanical Engineering, Isfahan, Iran
- Italian Institute of Technology, Advanced Robotics, Genova, Italy
- INP Grenoble, Laboratoire d'Automatique de Grenoble, Grenoble, France
- Jacobs University, Robotics Group, Bremen, Germany
- Karlsruher Institut für Technologie, FZI Forschungszentrum Informatik, Karlsruhe, Germany
- Katholieke Universiteit Leuven, Division PMA, Heverlee (Leuven), Belgium
- Massachusetts Institute of Technology, Department of Mechanical Engineering, Nonlinear Systems Laboratory, Cambridge, MA, USA
- Norges teknisk-naturvitenskapelige universitet, Centre for Ships and Ocean Structures, Institutt for teknisk kybernetikk, Trondheim, Norway
- Politechnika Poznanska, Instytut Automatyki i Inżynierii Informatycznej, Poznan, Poland
- Scuola Superiore S. Anna, Biorobotics Institute, ARTS Lab, Pisa, Italy
- Stanford University, Department of Computer Science, Artificial Intelligence Laboratory, Stanford, CA, USA
- Universidad de Sevilla, Departamento de Ingeniería de Sistemas y Automática, Sevilla, Spain
- Universidad de Zaragoza, Departamento de Informática e Ingeniería de Sistemas, Zaragoza, Spain
- Università Campus Bio-Medico, Biomedical Robotics and Biomicrosystems Lab
- Universität Bremen, Technologie-Zentrum Informatik und Informationstechnik, Bremen, Germany
- Université Pierre et Marie Curie, Institut des Systèmes Intelligents et de Robotique, France.

Industry and other:

Regarding the activities involving industrial partners, the University of Naples got a commission from Comau to develop a control system of the manipulator based on "force control". The PrismaLab received also funding from the following agency:

- Regione Campania.
- Alenia Aeronautica, Pomigliano d'Arco, Italy
- Alstom Inspection Robotics AG, Zürich, Switzerland
- Aslatech, Bologna, Italy
- BlueBotics SA, Lausanne, Switzerland

- Comau Robotics, Beinasco, Italy
- Danieli Automation, Buttrio, Italy
- EUnited Robotics – The European Robotics Association, Brussels, Belgium
- European Aeronautic Defence and Space Company (EADS) Innovation Works, Suresnes, France
- Galileo Avionica, Milan, Italy
- GPS Gesellschaft für Produktionssysteme GmbH, Stuttgart, Germany
- Graaltech, Genova, Italy
- KUKA Laboratories GmbH, Augsburg, Germany
- Oxford Metrics Group, Oxford, UK
- R.U.Robots Ltd, Manchester, UK
- SpaceTech GmbH, Immenstaad, Germany
- Tecnalía, San Sebastian, Spain
- Tecnomare, Venezia, Italy.

Projects

Some active projects are the following:

- RoDyMan European Project (2013–2018) Large scale Integrating Project “RoDyMan — Robotic Dynamic Manipulation”
- SHERPA European Project (2013–2017) Large scale Integrating Project “SHERPA — Smart collaboration between Humans and ground aErial Robots for imProving rescuing activities in Alpine environments”
- MARIS National Project (2013–2015) Anthropic Manipulation for Robots with Sensor Integration
- ARCAS European Project (2011–2015) Aerial Robotics Cooperative Assembly system
- SAPHARI European Project (2011–2015) Safe and Autonomous Physical Human-Aware Robot Interaction
- ROCOCO National Project (2011–2013) COoperative and COllaborative RObotics
- NECTAR National Project (2010–2013) NETworked Cooperative Teams of Autonomous Robots
- AIRobots European Project (2010–2013) Innovative aerial service robots for remote inspections by contact
- ECHORD European Project (2009–2013) the European Clearing House for Open Robotics Development.

Education

The automatic engineering faculty has about 80 students (three year degree) and about 40 students for the 5 year degree. They undergone about three course of robotics. The great majority of these students perform the research activities for their thesis at the laboratories.

The University of Naples host some students of secondary school in its laboratories (guided visit) to give to the young generations information about robotics. Some arm robots are particularly indicated to explain physical phenomena (like damping oscillator) to the students by visual methods.

They have a cooperation with the didactic laboratories of “Città della Scienza” and, from the 2014, a permanent robotic laboratory should be active in this reality. The laboratory was leaded together with the cognitive science department to teach the possibilities of the artificial intelligence.

The Prisma-Lab participates to the RomeCup organized by “Mondo Digitale”.

Suggestions/Criticalities

One of the principal difficulty encountered by PrismaLab is regarding the know-how developed by the students. Most of the students use to find jobs in foreign countries after master degree. So far it is difficult to give continuity to the scientific activity of the lab. This is due to two main reasons: the lack of money does not allow the university to pay them even a grant and farms linked to the territory are missing. In contrast, in other countries, many small local industries take on new graduates that can maintain a link with the universities of origin. For this reason, it would be desirable to link the students to the territory.

Another problem is the excessive bureaucracy that in some cases prevents their university to participate in new projects with loss of prestige for the Ateneo as a result

Lastly, the University suffers the lack of adequate space for its laboratories; in spite of many international projects gained, the laboratory is confined in very little space. This is particularly critic for the experiments of aerial robots.

Publications



Bruno Siciliano is Professor of Control and Robotics, and Director of the PRISMA Lab in the Department of Computer and Systems Engineering at University of Naples Federico II. His research interests include force and visual control, human-robot interaction and service robotics. He has co-authored 7 books, 70 journal papers, 170 conference papers and book chapters. He has delivered 100 invited lectures and seminars at institutions worldwide, and he has been the recipient of several awards. He is a Fellow of IEEE, ASME and IFAC. He has served on the editorial boards of several peer-reviewed journals and has been chair of program and organizing committees of several international conferences. He is Co-Editor of the Springer Tracts in Advanced Robotics, and of the Springer Handbook of Robotics, which received the PROSE Award for Excellence in Physical Sciences & Mathematics and was also the winner in the category Engineering & Technology. His group has been granted twelve European projects and he has recently received an Advanced Grant from the European Research Council for a project on robot dynamic manipulation. Professor Siciliano is the Past-President of the IEEE Robotics and Automation Society.

Prof. Siciliano together with Prof. Khatib is author of the Handbook of Robotics.

F. Basile, P. Chiacchio, D. Gerbasio, “On the implementation of industrial automation systems based on PLC”, IEEE Transactions on Automation Science and Engineering, in press, 2013.

H. Sadeghian, L. Villani, M. Keshmiri, B. Siciliano, “Dynamic multi-priority control in redundant robotic systems”, Robotica, in press, 2013.

V. Lippiello, B. Siciliano, L. Villani, “A grasping force optimization algorithm for multi-arm robots with multi-fingered hands”, IEEE Transactions on Robotics, in press, 2013.

V. Lippiello, F. Ruggiero, B. Siciliano, L. Villani, “Visual grasp planning for unknown objects using a multi-fingered robotic hand”, IEEE/ASME Transactions on Mechatronics, in press, 2013.

Marino, L. Parker, G. Antonelli, F. Caccavale, “A decentralized architecture for multi-robot systems based on the null-space-behavioral control with application to multi-robot border patrolling”, Journal of Intelligent and Robotic Systems, in press, 2013.

G. Antonelli, F. Arrichiello, F. Caccavale, A. Marino, “A decentralized controller-observer scheme for multi-agent weighted centroid tracking”, IEEE Transactions on Automatic Control, in press, 2013.

G. Antonelli, “Interconnected dynamic systems. An overview on distributed control”, IEEE Control Systems Magazine, in press, 2013.

G. Palli, C. Natale, C. May, C. Melchiorri, T. Würtz, “Modelling and control of the twisted string actuation system”, IEEE/ASME Transactions on Mechatronics, in press, 2013.

- K. Caluwaerts, M. Staffa, S. N'Guyen, C. Grand, L. Dollé, A. Favre-Felix, B. Girard, M. Khamassi, "A biologically inspired meta-control navigation system for the Psikharpax rat robot", *Bioinspiration & Biomimetics*, in press, 2013.
- F. Caccavale, A. Marino, G. Muscio, F. Pierri, "Discrete-time framework for fault diagnosis in robotic manipulators", *IEEE Transactions on Control Systems Technology*, in press, 2013.
- Minardo, A. Coscetta, S. Pirozzi, R. Bernini, L. Zeni, "Modal analysis of a cantilever beam by use of Brillouin based distributed dynamic strain measurements", *Smart Materials and Structures*, 21(12), 2012.
- Cavallo, G. De Maria, C. Natale, S. Pirozzi, "Classes of strongly stabilizing bandpass controllers for flexible structures" *Advances in Acoustics and Vibration*, ID 249478, 2012.
- F. Basile, P. Chiacchio, D. Del Grosso, "A control oriented model for manual-pick warehouses", *Control Engineering Practice*, 20, 1426–1437, 2012.
- G. Palli, S. Pirozzi, "A miniaturized optical force sensor for tendon-driven mechatronic systems: Design and experimental evaluation", *Mechatronics*, 22, 1097–1111, 2012.
- S. Pirozzi, "Multi-point force sensor based on crossed optical fibers", *Sensors and Actuators, A: Physical*, 183, 1–10, 2012.
- G. De Maria, C. Natale, S. Pirozzi, "Force/tactile sensor for robotic applications", *Sensors and Actuators A: Physical*, 175, 60–72, 2012.
- F. Basile, P. Chiacchio, G. De Tommasi, "On K-diagnosability of Petri nets via integer linear programming" *Automatica*, 48, 2047–2058, 2012.
- F. Basile, F. Caccavale, P. Chiacchio, J. Coppola, C. Curatella, "Task-oriented motion planning for multi-arm robotic systems", *Robotics and Computer-Integrated Manufacturing*, 28, 569–582, 2012.
- F. Basile, P. Chiacchio, J. Coppola, "A hybrid model of complex automated warehouse systems — Part II: Analysis and experimental results", *IEEE Transactions on Automation Science and Engineering*, 9, 654–668, 2012.

ISSIA: Summary Table	
Institute	Istituto di Studi sui Sistemi Intelligenti per l'Automazione, CNR Via G. Amendola 122/D-O - 70126 Bari, Italy
Year of foundation	
Reference person	Dr. Nicola Veneziani, (+39)0805929420 direttore@issia.cnr.it
Website	http://www.issia.cnr.it/
Scientific Areas	
Robotic Applications	
Scientific Expertise	automation, signal processing decisional soft computing
Team size	40
Senior researchers	5

Introduction

The topic of ISSIA is the advancement of knowledge and its industrial and social aspects, in the field of Intelligent systems with prevailing interest the following areas of research:

- Robotics aimed at developing intelligent machines that can autonomously in unstructured environments.
- Automation to increase the performance, productivity and safety of complex systems.
- Processing of signals and images both in hardware and software for the acquisition and processing of multispectral, multitemporal and multi-platform signal.
- Measurement systems and decision support based on soft-computing applications.

Educational activity

Many master thesis have been carried out in the institute, some of them have been continued by an external grant won by the students or by PhDs thesis. The thesis are generally relative to the course of Automation, electronic or informatics engineering.

Research

Some of the research project where the ISSIA was involved are the following:

TECSIS: Diagnostic technologies and intelligent systems for the development of the archaeological sites of Southern Italy - funded by the Ministry of research on the PON and led by ENEA allowed the development of a number of technologies for the diagnostics, the maintenance and the fruition of the cultural heritage. Development of the remote museum (much more than virtual museum) by robotics telepresence technologies.

APEX Design and development of a prototype of a mobile device for remotely controlled ultrasonic inspection of internal part of a aeronautical wing of Boeing 787. Sponsored by Alenia SpA.

Issia is also involved in FP7 project together with University of Salento regarding ambient awareness for autonomous agricultural vehicles (FP7-ERA-NET ICT-AGRI QUAD-AV). It is dealing with integration of different sensory modalities and multi-algorithmic methods to detect various types of obstacles and build a database that can be used for the control of an agricultural autonomous vehicle. The project aims to investigate four technologies: stereo vision, radar, ladar and thermography. Fruit quality classification was also developed by color analysis.

BAITAH - Methodology and Instruments of Building Automation and Information Technology for pervasive models of treatment and Aids for domestic Healthcare (PON 2007-2013 ICT).



Fig. 77 - Robot used for cave exploration

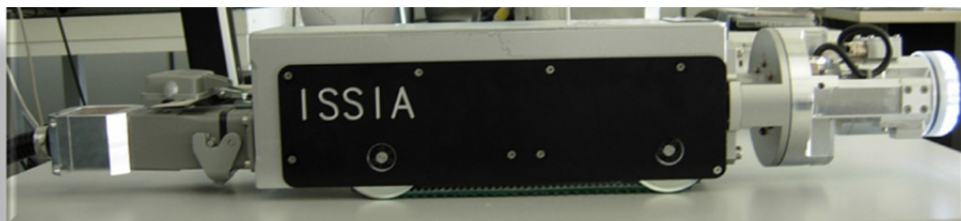

Fig. 78 - Prototype of mobile robot for non-destructive inspection of a multispar structure of Boeing 787

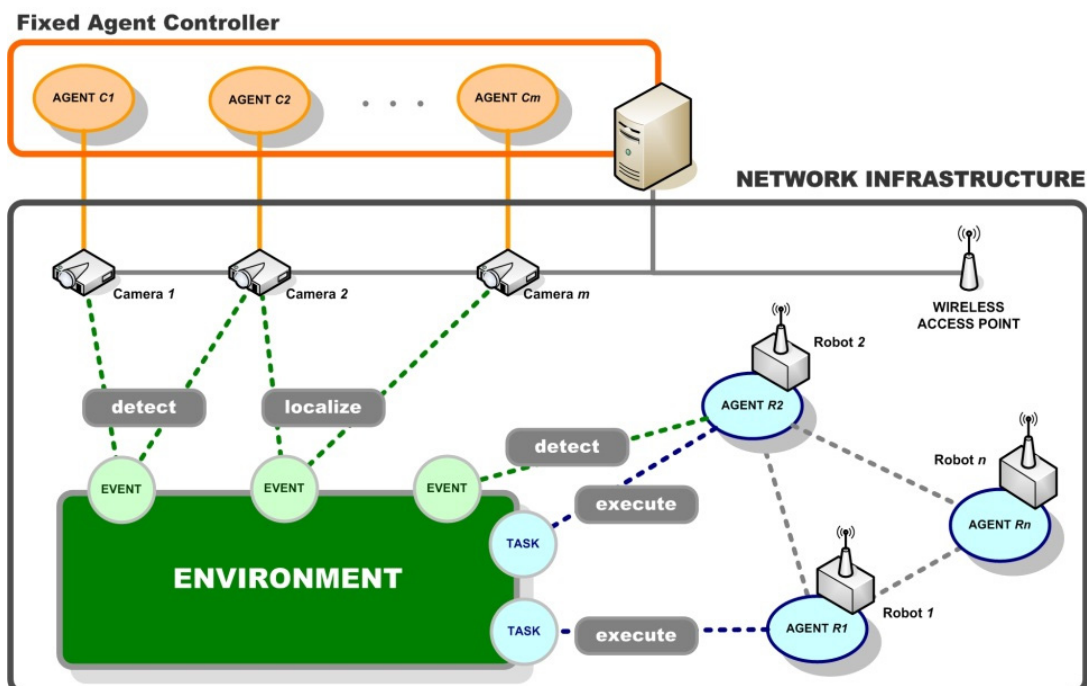

Fig. 79 - Architecture of the surveillance system



Fig. 80 - Multisensorial mobile platform

The objective of the project is to develop a system for “ambient intelligence” for surveillance and security of non-self-sufficient people in the home. The system consists of a network of fixed nodes (cameras) and mobile (robots). Through the analysis of the images acquired by the cameras the system will be able to recognize people and objects, to locate them in the environment and to recognize the activities of the subjects in the scene. In addition, the mobile nodes, consisting of multisensory robotic platforms will support the fixed nodes in areas not covered by the cameras and for closer examination of the areas to be monitored. Behavior classification and degradation of performances of elder people are included in the project. The help to handicap people was also performed by developing a three dimensional map of the Swabian Castle (in Bari) for blind people. It render a force feedback on a joystick when obstacle are encountered.

Other activities

Regarding the activities involving industrial partners ISSIA has been committed to use RFID technology for navigation of mobile robots and mapping environments.

In the field of mobile robotics, RFID tags distributed in the environment can be used by the robot to detect objects, to obtain information on their location and on their own and still receive instructions to perform certain tasks. ISSIA have equipped the mobile robotic platform PeopleBot with a reader and two RFID antennas. First a model of the RFID system has been learned by using fuzzy inference. Following this model has been used both to locate on the map Tag environment, and to locate the robot.

Another commission is regarding the use of multisensory mobile robots for surveillance of structured environments.

ISSIA has developed a mobile robotic platform able to perform tasks such as surveillance image processing to detect objects removed or abandoned and are used to track people in the surroundings. Moreover, always in the surveillance field, has developed methods to keep track of the people movement. The ISSIA has set, and stands still, the objective of implementing strategies tracking of distributed nature. This line of research aims to develop robust algorithms and scalable performance invariants to take in account the possibility of the addition or removal of nodes in the network. In order to allow the movement of the robots involved in the operations of tracking, has been developed distribute architecture motion control, maintaining the connectivity of the network of communication.



Fig. 81 - People follower

Furthermore, to allow the contemporary estimation of several targets in movement has been developed a strategy of assignment of the target that allows to balance the computational load and to harmonize the motion of the entire network in order to minimize the movement of the single robot.

Mission control systems for decentralized multi-robot

In certain contexts, the cooperation of several robotic units is a necessary requirement to achieve a certain goal. In this context different solutions of cooperative control operations for multi-robot systems have recently been presented in the literature. The ISSIA has contributed to the development of methodologies and architectures for distributed mission control with application to surveillance of large environments, sensor networks, and logistics. In particular, this line of research is focused on distributed control of execution of the operations, and therefore of the missions, and on the assignment tasks of the operations to the robot, based on the capacity possessed by the individual robots. Have been successfully developed innovative models and algorithms for controlling execution of missions and for the assignment of decentralized operations.

The ISSIA has many relationship with other Italian and foreign research institute. We remember the University of Salento, Bari's Polytechnic, University of Rome, the Australian Centre for Field Robotics University of Sydney, the Danish Technological Institute Centre for Robot Technology, the IRSTEATSCF - Technologies and information systems for agricultural systems Aubière, France, the Fraunhofer Institut für Intelligente Analyse- und Informationssysteme (IAIS) Sankt Augustin, Germany, the University of Texas at Arlington Research Institute - Advanced Controls and Sensors Group Arlington (TX), USA. Moreover the relationships with local industries like ICAM Putignano (BA) - Italy, the SmartID Sannicola (LE), the SABACOM Taranto - Italy

Needs

The main problems suffered by the Institute are those typical of the Italian research that is its lack of a direction for the activities and of a long term vision strategy.

In particular, the reference is to set up a strategical research vision, where the researchers, once hired by the institute, can develop, maintain and improve an high skill beyond the limits of a short term research contract. The short term policies generates the same problems that is typical of the Universities of a critical or impossible conservation of the know-how, with loss of money and international competitiveness.

Moreover the institute claims that there is a excess of bureaucracy overhead that paralyze the money situation also when the project is just paid.

Another political problem is the little dialogue with local realities and with companies that do not know what you are doing. They have not the vision to ask the solution of their problems through a shared project. In the foreign countries is very different.

In the absence of a dialogue that seeks cooperation on a long time even when the problems could be solvable there are difficulties; there is not a strategic vision to address the research potentialities. The little company can cooperate better than the big owing their higher dynamicity.

References

Milella; G. Reina; J. Underwood; B. Douillard (2012), Visual Ground Segmentation by Radar Supervision, Robotics and Autonomous Systems, Available online 8 November 2012, in press, doi: 10.1016/j.robot.2012.10.001.



A. Milella; G. Reina; J. Underwood (2012), Self-learning Classification of Radar Features for Scene Understanding, Robotics and Autonomous Systems, Vol. 60, No. 11, pp. 1377–1388.



G. Cicirelli, A. Milella, D. Di Paola (2012), RFID Tag Localization by using Adaptive Neuro-Fuzzy Inference for Mobile Robot Applications, Industrial Robot: An International Journal, Vol. 39, No. 4, pp. 340 – 348.

G. Reina; A. Milella (2012), Towards Autonomous Agriculture: Automatic Ground Detection Using Trinocular Stereovision, Sensors , Vol. 12, No. 9, pp. 12405-12423.

A. Milella, G. Reina, J. Underwood, B. Douillard (2011), Combining Radar and Vision for Self-Supervised Ground Segmentation in Outdoor Environments, Proc. of IEEE/RSJ International Conference on Intelligent Robots and Systems, San Francisco.



A. Distante (2008), A. Milella, G. Cicirelli, RFID-Assisted Mobile Robot System for Mapping and Surveillance of Indoor Environments, Industrial Robot: An International Journal, Vol. 35, No. 2, pp. 143-152.

G. Cicirelli and A. Milella, “Environment Modelling with an Autonomous Mobile Robot for Cultural Heritage Preservation and Remote Access”, Robotics, Automation and Control, pp. 494,(ISBN 978-953-7619-18-3), I-Tech, 2008.



Attolico G., Gramegna T., Cicirelli G., Distante A., “Automatic 2D and 3D Model reconstruction in a pre-historical cave during robot inspection”, 37th International Symposium on Robotics (ISR 2006) Munich, Germany, 2006.

Cicirelli, G., Milella, A., and Distante, A., Fruition of a Pre-Historical Cave Using a Mobile Robot, 3rd International Conference on Autonomous Robots and Agents (ICARA 2006), 12-14 December 2006, Palmerston North, New Zealand.

D. Di Paola, A. Milella and G. Cicirelli, “An Experimental Testbed for Robotic Network Applications”, in Advances in Autonomous Mini Robots, Springer, feb 2012.

D. Di Paola, A. Gasparri, D. Naso and F.L. Lewis, “Decentralized Discrete-Event Modeling and Control of Task Execution for Robotic Networks”, in IEEE Conference on Decision and Control (CDC), 2012.

S. Giannini, D. Di Paola and A. Rizzo, “Coverage-Aware Distributed Target Tracking for Mobile Sensor Networks”, in IEEE Conference on Decision and Control (CDC), 2012.

A. Gasparri, D. Di Paola, A. Giua, G. Ulivi and D. Naso, “Consensus-Based Decentralized Supervision of Petri Nets”, in 50th IEEE Conference on Decision and Control and European Control Conference (CDC), 2011.

A. Petitti, D. Di Paola, A. Rizzo and G. Cicirelli, “Consensus-based Distributed Estimation for Target Tracking in Heterogeneous Sensor Networks”, in 50th IEEE Conference on Decision and Control and European Control Conference (CDC), 2011.

A. Petitti, D. Di Paola, A. Rizzo and G. Cicirelli, “Distributed Target Tracking for Sensor Networks with Only Local Communication”, in 19th Mediterranean Conference on Control and Automation, 2011.

- D. Di Paola, A. Gasparri, D. Naso, G. Ulivi and F. L. Lewis, "Decentralized Task Sequencing and Multiple Missions Control for Heterogeneous Robotic Networks", in IEEE International Conference on Robotics and Automation (ICRA), 2011.
- D. Di Paola, D. Naso and B. Turchiano, "Consensus-based Robust Decentralized Task Assignment for Heterogeneous Robotic Networks", in American Control Conference (ACC), 2011.
- D. Di Paola, A. Milella, G. Cicirelli and A. Distante, "An Autonomous Mobile Robotic System for Surveillance of Indoor Environments", International Journal of Advanced Robotic Systems. vol. 7, no. 1, pp. 19-26, jan 2010.
- D. Di Paola, D. Naso, A. Milella, G. Cicirelli and A. Distante, "Multi-Sensor Surveillance of Indoor Environments by an Autonomous Mobile Robot", International Journal of Intelligent Systems Technologies and Applications. vol. 8, no. 1-4, pp. 18-35, jan 2010.
- A. Milella, D. Di Paola, P. L. Mazzeo, P. Spagnolo, M. Leo, G. Cicirelli and T. D'Orazio, Active Surveillance of Dynamic Environments using a Multi-Agent System, in 7th IFAC Symposium on Intelligent Autonomous Vehicles (IAV), 2010.
- D. Di Paola, D. Naso and B. Turchiano, "A Heuristic Approach to Task Assignment and Control for Robotic Networks", in IEEE International Symposium on Industrial Electronics (ISIE), 2010.
- D. Di Paola, G. Cicirelli, A. Distante, D. Naso and B. Turchiano, "Matrix-based Discrete Event Control for Surveillance Mobile Robotic", Journal of Intelligent and Robotic Systems. vol. 56, no. 5, pp. 513-541, dec 2009.

Catania

The image of close cooperation between school, University and High Tech Industry

A short sightseeing

Catania represents one of the most significant centers of the Robotics technology in Italy for the simultaneous presence of the three components of penetration of the discipline into the low order schools, strenght of the research group in the Academy deeply endowed in international project participation and presence of the worldwide level industry ST microelectronics, interested in the opportunities that the robotics discipline will offer to a global competitor and focused to the development and marketing of components (sensors, power

management, ICT chips, etc...).

ST Microelectronics is also becoming an attraction pole that is pushing other non-local players, like S. Anna Institute, to open local interfaces to the site of the firm. A third important element is the recently opened “Città della Scienza” (Fig. 82 and Fig. 83). It has the aim to become a link between the Academy and the lower instruction grades and one of the three pavilions is devoted to automation and robotics. The Robotics group of University is deeply involved in the initiative and frequently there are contacts with the technical institutes and with any school that would give of its own students some preliminary information relevant to what “robotics” really is.

On this topic is important to mention the membership of the Academy and ST Microelectronics in the National Robotics Network, an educational Association signed by the main research and educational institutes in Italy to push educational initiatives around the whole national territory, offering lessons and seminars, organizing teachers supports, cooperating in the realization of educational laboratories in the schools and so on.



Fig. 82 - Città della scienza - Catania



Fig. 83 - Città della Scienza (accesso)

University of Catania – DIEEI

DIEEI: Summary Table	
Institute	University of Catania
Year of foundation	
Reference person	Prof. Giovanni Muscato
Website	
Scientific Areas	Mobile robotics, Artificial Intelligence
Robotic Applications	Walking and climbing Robots, Agriculture, Industrial applications
Scientific Expertise	Path planning, Advanced control systems, Sensing, Man-Robot Interfaces
Team size	40
Senior researchers	7



Fig. 84 - Example of robotics in agriculture

DIEEI put on the research table a Robotics Team based on 7 professors and assistant professors and a number of students, docs and post-docs that ranges around 30 to 40 high skilled people.

This well driven group is involved in a number of international initiatives starting from the membership to the CLAWAR (CLimbing And WAalking Robots), a european network, born as a funded Excellence Network, but still operating now and that includes high level research bodies like CSIC (Spain) and RMA (Belgium).

Main capabilities of this group are addressed along two main lines: the robotics mobility and the fusion of electronics and neural

studies (Insectoids realization and study) where a number of different researches like machine intelligence, neural networks, brain study, neurology, but also genetic research are joined together to increase the capability to offer intelligent and adaptive behaviours to artificial beings.

In the following we reported some of the realizations of the group.

- The robotics platform in Fig. 84 has been designed for a medium/large production. It is for spraying anti-parasitic to vineyards and is also able to operate in greenhouses. Unfortunately the SME that initially asked for this product was forced to close by the economic crisis effects and the system is waiting for a possible other entrepreneur.
- Study of Etna behavior (Fig. 85 and Fig. 86) is carried out by the Robotics group together with the INGV and using both terrestrial and aerial approach.

ROBOVOLC has been one of the first, all terrain, systems; it proven to be able to overcome most of the ETNA terrain roughnesses and realize local and global analysis of the volcano conditions. Most of the control decisions are taken autonomously by the robot depending on the terrain characteristics sensed by the “on board” equipment and evaluated by the data coming by the dynamical inertial unit of the robot.



Fig. 85 - RobovolC



Fig. 86 - UAV for Etna studies

For a more quick and real time study of changing conditions, for a more effective analysis of the volcano gases and for a study from the sky of the terrain formations, DIEEI is developing an UAV able to bring significant sensing payloads. The flight is allowed (under the law conditions) by the peculiar condition of the aerial space around ETNA, forbidden to all civil flights, and by the substantial deserted conditions of the area.

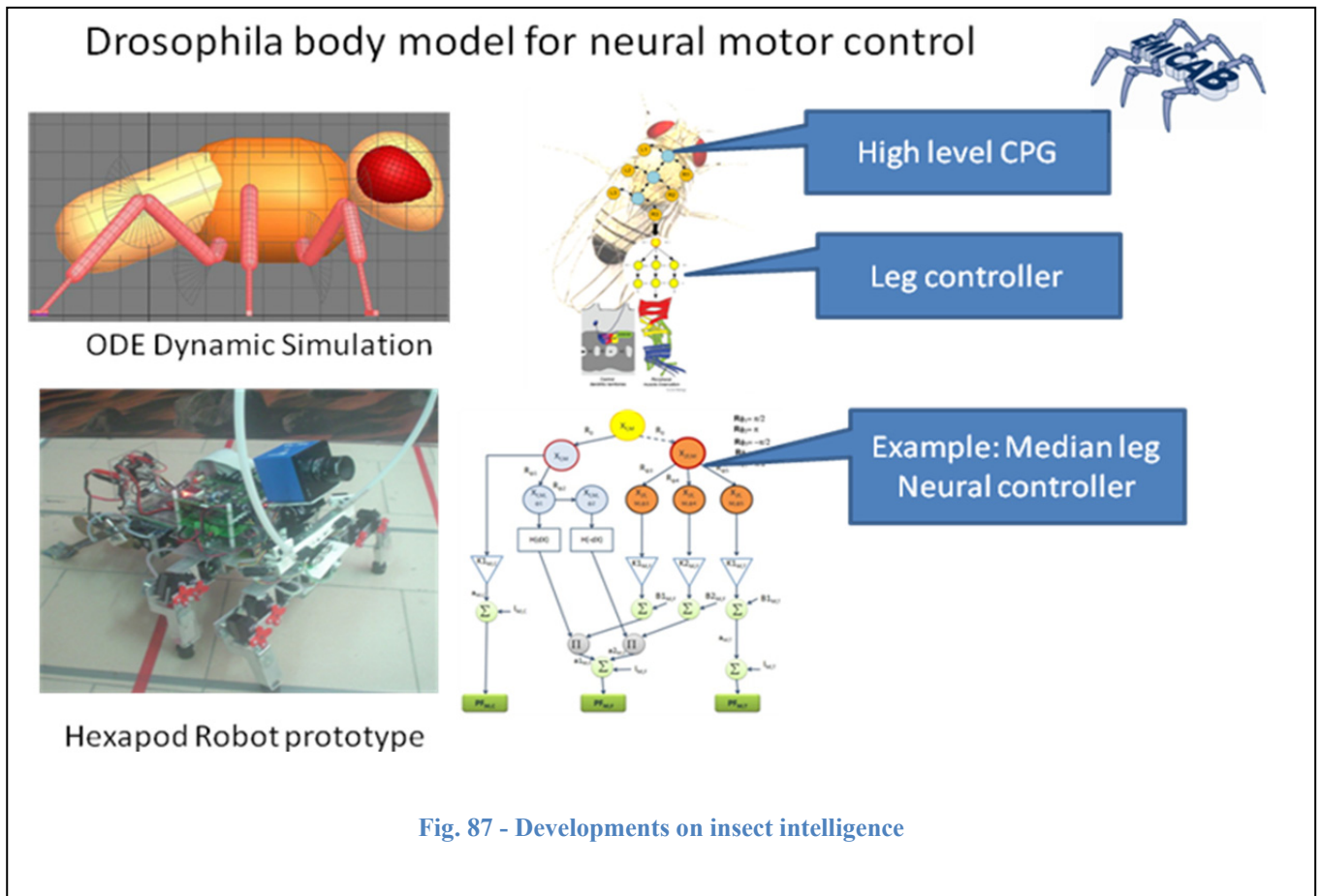

Fig. 87 - Developments on insect intelligence

The other prominent research line of Catania University is in a more fundamental research, aiming at understanding how to put “intelligence” in an artificial being.

This line is less close to the applications: it is still a fundamental research activity. The Drosophila model, used for the studies, is a 150 Kneuron network. It has been shown that a so limited neural system is anyway able to manage and exhibit a surprising number of behaviors (Fig. 87 and Fig. 88).

Learning, curiosity, decision making processes, realization of large experience database have been proven to be within the capabilities of such a brain neural model. All of these processes can be replicated, as has been demonstrated, on an electronic analog based on the well known CNN network. The realization of such a network in a FPGA chip is the ultimate goal when the knowledge of the Drosophila brain will be pushed to a satisfactory level.

The research is in progress, in the frame of an international cooperation that includes some of the more prestigious European Institutions.

Insect brain neural model for operant learning, attention and expectation

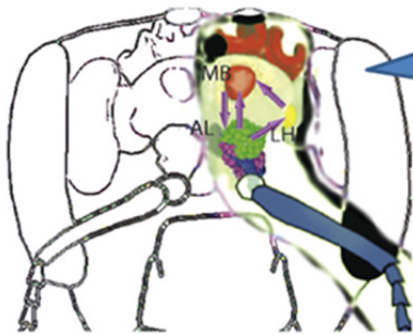

The Antennal Lobes (ALs) project olfactory information to the Mushroom Bodies (MBs) Kenyon cells (KC) and Lateral Horns (LHs) via Projection Neurons (PNs). Feedback connections from MBs to AL realize at top-down modulation leading to the emergence of an attentional loop as well as to the arousal of basic expectation behaviors in case of subsequently presented stimuli.

Computational model via spiking neural networks

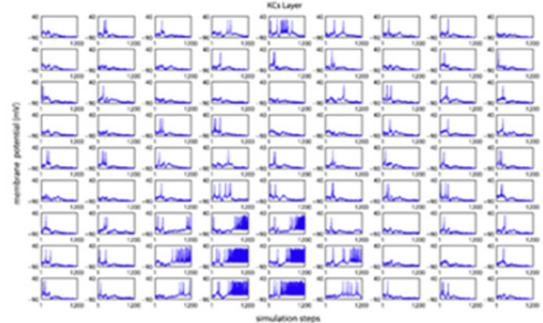
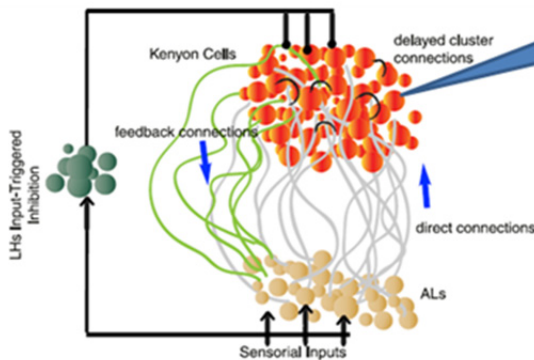

Fig. 88 - Insect brain neural model

Main results (papers and realizations of contact persons)

P. Arena, L. Fortuna, G. Muscato , M. G. Xibilia, “Neural Networks in Multidimensional Domains: fundamentals and new trends in modelling and control”, Lecture Notes in Control and Information Sciences Vol. 234, Springer-Verlag, Berlin (Germany), 1998.



G.S. Virk, G. Muscato, A. Semerano, M. Armada and H.A. Warren, “The CLAWAR project on mobile robotic”, Industrial Robot: An International Journal Vol.31, • N. 2, pp. 130–138, 2004.

S. Guccione, G. Muscato, “Control Strategies Computing architectures and Experimental Results of the Hybrid Robot Wheeleg”, IEEE Robotics and Automation Magazine, (IEEE Piscataway, U.S.A.), Vol.10, N.4, pp.33-43, December 2003.

L. Fortuna, G. Muscato and G. Nunnari, “On the Bilinear Transformation of LQG- Balanced Realizations”, Automatica, Vol. 31, No.2, pp. 349-351, (Elsevier, U.K.), Febbraio 1995.

S. Livatino, G. Muscato, S. Sessa, C.Koffel, C. Arena, A. Pennisi, D. Di Mauro, E. Malkondu, “Depth-Enhanced Mobile Robot Teleguide based on Video Images”, IEEE Robotic and Automation Magazine, Special issue on New Vistas and Challenges in Telerobotics, Vol15,N.4, pp.58-67, December 2008 (Digital Object Identifier 10.1109/MRA.2008.929927)

G. Astuti, D. Longo, C. D. Melita, G. Muscato, A. Orlando, “HIL tuning of UAV for exploration of risky environments”, International Journal on Advanced Robotic Systems, Vol.5, N.4, (ISSN 1729-8806), December 2008.

M. Branciforte, A. Meli, G. Muscato, D. Porto, "ANN and Non-integer Order Modeling of ABS Solenoid Valves", IEEE Transactions on Control Systems Technology, Vol.19, No.3, May 2011, pp.628-635 <http://dx.doi.org/10.1109/TCST.2010.2049999>.

G. Muscato, F. Bonaccorso, L. Cantelli, D. Longo and C.D. Melita, "Volcanic environments: Robots for Exploration and Measurement", IEEE Robotics & Automation Magazine, Vol.19, No.1, March 2012, pp.40-49, DOI: 10.1109/MRA.2011.2181683.

S. Livatino, F. Banno', G. Muscato, "3D Integration of Robot Vision and Laser Data with Semi-Automatic Calibration in Augmented Reality Stereoscopic Visual Interface", IEEE Transactions on Industrial Informatics, vol.8, N.1, Feb. 2012, pp. 69-77, DOI: 10.1109/TII.2011.2174062.

F. Bonaccorso, L. Cantelli, G. Muscato, "An Arc Welding Robot Control for a Shaped Metal Deposition Plant: Modular Software Interface and Sensors", IEEE Transaction on Industrial Electronics, vol.58, N.8, Aug.2011,pp. 3126-3132, <http://dx.doi.org/10.1109/TIE.2011.2114311>.

S.Livatino, G.Muscato, F.Privitera , "Stereo Viewing and Virtual Reality Technologies in Mobile Robot Teleguide", IEEE Transactions on Robotics Vol.25,No.6, December 2009 (DOI: 10.1109/TRO.2009.2028765).

L Patanè, S Hellbach, AF Krause, P Arena, V Dürr, "An insect-inspired bionic sensor for tactile localization and material classification with state-dependent modulation", Frontiers in Neurorobotics 6, 8



P Arena, L Patané, A Vitanza , "Autonomous learning of collaboration among robots", Neural Networks (IJCNN), The 2012 International Joint Conference on, 1-8

P Arena, L Patané, PS Termini , "Modeling attentional loop in the insect Mushroom Bodies", Neural Networks (IJCNN), The 2012 International Joint Conference on, 1-7

F Karabiber, P Arena, L Fortuna, S De Fiore, G Vagliasindi, S Arik, "Implementation of a moving target tracking algorithm using Eye-RIS Vision System on a mobile robot", Journal of Signal Processing Systems 64 (3), 447-455

I Aleo, P Arena, L Patané , "Incremental learning for visual classification using Neural Gas", Neural Networks (IJCNN), The 2010 International Joint Conference on, 1-6

ST Microelectronics

ST Microelectronics: Summary Table	
Institute	ST Microelectronics - Catania
Year of foundation	
Reference person	Nunzio Abate
Website	
Scientific Areas	
Robotic Applications	
Scientific Expertise	
Team size	10
Senior researchers	

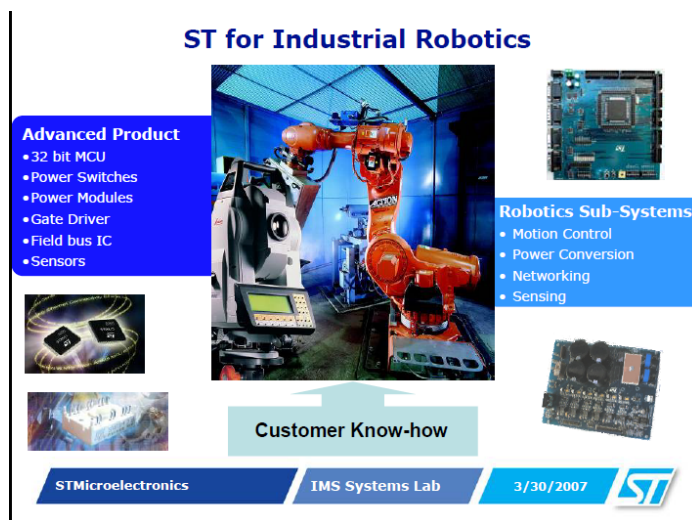

Fig. 89 - Application of ST products for robotics

This is perhaps not the best place where to offer information on ST Microelectronics, one of the largest microelectronics players in the world, seventh in the world ranking of chip producers; the objective is to give an idea of its policy with respect to the robotics developments. We also exclude here the production and the research for generic automation market, because automation in wide sense involves practically all the microelectronics production.

With special reference to robotics, intended as the technology that realizes

intelligent driven physical actions in the world ST is following three main lines:

1. The research and realization of very low cost chips to embed computational power inside robotics units (see Fig. 90);

2. The research and development of proprioceptive sensing units, able to supply the perception of the acceleration, orientation, localization of the robotics unit in the world and to realize the relevant computations (together with the item 1.);
3. The research of compact and powerful electronic systems for motors actuation;

The Company is still in the evaluation phase, in order to devise if putting a lot of effort in this field or maintaining a low profile with limited, high quality, production. Currently it is anyway entering in the worldwide event that still is Arduino, another Italian product that was able to join an extremely low cost (tens of Euro) with a well-built software development system.

Considering that the interest of ST is in the mass market, the analysis is aiming at understanding if the dimension of that small, low-cost automation, that could be interested by these lines of Micros and PCB components.

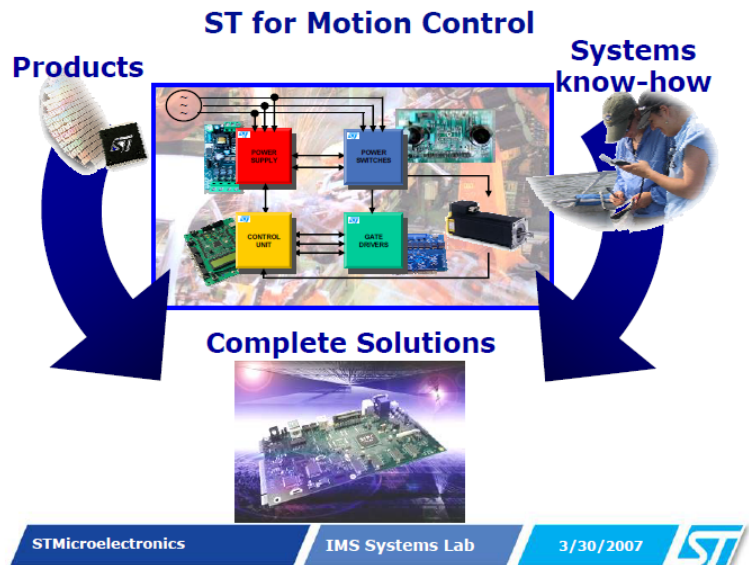

Fig. 90 - Approach of ST to robotics enabling technologies

This strategy is reinforced by the cooperation with academic groups, able to represent an “antenna” in the research horizon and to suggest the most convenient improvements to the core line of devices. Beyond the classical cooperation with Catania Academy (basically the group of Prof. Muscato) that also represented a source of very high level technician since the creation of the pole in Catania, ST has recently had an agreement with S. Anna Institute, probably the largest research center in Robotics in Italy, to open a joint cooperation site in Catania and to increase its capability to maintain a strong sensitivity on the new progresses and the new possibilities that the worldwide research is opening in this field.

Apart from its industrial initiatives, ST is becoming also a sponsor of educational robotics projects, aiming mainly at the high schools, but also to middle schools. It was one of the contributors and supporters for the realization of the robotics part of the Catania “Science City” and entered into the Italian network “Rete della Robotica”, aimed at giving new opportunities to the students of understanding and participating to this special world of advanced robotics.

A short analysis and a proposals for an Italian Robotics network

The Italian capability in Robotics, as results by the work reported in this work, is a very high level one, also thinking at a worldwide level. It is endowed with hundreds of senior researchers of top class and able to compete and cooperate with the major international research organizations and with thousands of very skilled young students and PhD supporting their effort.

In terms of enterprises operating in this area the analysis become quickly articulated.

Large firms able to operate in pure robotics in the global arena are relatively few in the whole world and generally are not of big dimensions: Kuka, Motoman, COMAU are certainly among the greatest players and they have dimensions of medium-large enterprises, but it is difficult to compare these realities to players that in other fields grow up to gigantic dimensions: apart the automotive industry, we can think to operators like Nokia in Finland that is a nation-wide industry, grown to these dimensions thanks to the explosion of telecommunication market.

Robotics market has the potential to achieve the same impact or also greater, but the difference is that its products are much more distributed “inside” other products and then inside other industries. It is not so easy to identify a killing product like the smartphone in telecommunication or the family car in the automotive. Some attempts have been done with the autonomous vacuum cleaners and similar products, currently perhaps the larger world success in this field; nevertheless, having in mind that the base industry of these products is anyway a relatively small part of the global market, we can understand that the best way to convert in richness the results of this research is not centered on the research of the killing application.

Consequently what is needed to allow a fruitful exploitation of the national technological capability is to prepare the terrain to deeply penetrate inside the structure of little and medium enterprises in all the sectors of the daily life.

Italy has a good presence of high level industries in niche or specialized markets (Finmeccanica for security and military, COMAU for automotive applications, STM for electronic components and so on), but what is lacking is the capability to easily answer to requests arising from the huge base of SMEs fighting to improve their competitiveness in the global market.

In principle this could represent a space for a meta-industry: a consultant enterprise able to supply solutions to small level request. This is the well-known problem of technological brokering, but the success of similar initiatives in our country have always been uncertain and with limited life. Without to pretend to develop here a possible and ambitious recipe to this problem we want to underline the importance of a substratum of skills easily reachable.

Most of the largest research operators in our field have tried different paths to reach partial and territorial results along this way. The Pisa area, for instance, try to operate basically through the dissemination of spin-offs and startups, trying to support them up to the reaching of a market competitiveness, the northern area often operated through the opening of technological counters; perhaps one of the most interesting attempt in these years is the action deployed by the Foundation Bruno Keller that was able to achieve a good image along the many SMEs that are spread along the Trentino area. Other development centers, most of them in fact, base their technological transfer upon the credibility of the University institution or of the Research Institute (CNR, ENEA, IIT) to establish their own local network of contacts and of industrial cooperation.

What is generally the basic elements for the success of technology transfer are, in our view, three components in the following order:

- The credibility of the organisations; the businessman and the market must trust in its technology supporter;
- The easiness of access to the right solution developer;
- The locality; the industry, especially if it is an SME, needs for an easy and continuous contact with the technology supplier to adequate its aims to the development of the market and of the outside technological level.

This has been understood by other countries (France, for instance) and the answer was the realization of an open network of research groups, often launched by the public administration. In the foreign cases the network realization has been stimulated by small funding to make more interesting the implementation of active cooperation among the groups. Nevertheless, the true added value was, in the end, the existence of a “technology tank”, large enough to cover many of the possible request of the possible industrial end users.

A similar mechanism could also be launched in our country. The availability of relatively small promotions is a possible action to increase the success of the project, but is not a key point if the economical conditions prevent its implementation.

Many Universities have already established several forms of aggregation (like the mentioned ISME or the multiple agreements carried out by IIT) without the need of an explicit external award. What is important is the availability of a coordination group built to implement and push this kind of operation.

What is important is the approval of a set of rules that can overcome many of the current limitations existing to realize associations among non-profit organizations like Academies and Research Institutes. For instance ISME, being an interuniversity centre cannot accept Research institutes like CNE and ENEA. On the other end, the exploitation of other standard form of association, imposes to the members to manage a common administration that must follow rules thought for private bodies more than for public research institutions or to strongly limit the time extend validity of the association.

Still, a group that must integrate, technician, informatics and media experts is also a crucial component of the mechanism. Perhaps nobody of the existing research organization is currently able to set up such a structure that requires a daily engagement to maintain the web sites, the contact among the different operators, the collection of information in the research world, but the associations of several operators probably could supply the needed human resources.

We are well aware that the problem is worthy of a greater technical detail and of the job of administration specialists, but this isn't certainly the place and the space to prepare a fully operational proposal. We just tried, in this report, to launch a possible and perhaps interesting idea/tool to foster the competitiveness of Italian system in this area.

The group that worked to this report, supported by the Direction of ENEA that are responsible for media and event management, is already working to realize the basic technical infrastructures to implement different forms of possible networking and interaction with the research operators of this technology in Italy and with other different players of the area.

The success of the possible initiative is anyway the result of a global action, were all the participant will have to give their contribution and their willing to the final result.

Conclusions

This job is not to be considered as a self standing report, but is a first effort towards the offer of a practical way to improve the capability of Italian high tech industry to access to the Academic and public research, to increase the integration among the different research areas, to give to the public administration more efficient tools to enhance the initiative of the research operators offering to them rules and opportunities that can widen the spillover effect on the competitiveness of the whole Italian society.

Our intention is to launch a number of initiatives based on the ideas expressed here in a very preliminary form. This book itself needs to be integrated because, as we already said, many of the players are not adequately represented or are lacking at all. To obtain this result we are preparing a portal on national robotics offering to everybody a free access to the book, but also offering to the authors the opportunity to update and revise their presentation and to inform interested people about international events, especially those where the Italian participation is significant and to organise and spread the information about other national events.

We also hope to have the opportunity to focus the attention of local and governmental bodies on the requests coming by the network of robotics research by means the organisation of public Conferences, that we hope to realise with an important participation of the main representative of the network and with the participation of the authorities.

At the end of this first part of the job we started, I intend to thanks again here all the colleagues of academies, research centres and industries for the kindness and availability that has been demonstrated in all of my visits and to thanks also my ENEA's colleagues for their enthusiasm and support in every situation, including the effort to present this report in two languages. A special gratitude is also for the ENEA's Management and for the Directions that care multimedia diffusion, in particular the Director Diana Savelli, that made possible to publish and spread this report and that promised its support also in the future initiatives of this line.

Published by ENEA
Relations Central Unit, Communication Service
Lungotevere Thaon di Revel, 76 – 00196 Rome
www.enea.it

Editorial review: Giuliano Ghisu
Cover design: Bruno Giovannetti

Printed in November 2013
Print: Varigrafica Alto Lazio (Nepi – Viterbo)